



Class XII

Xam idea

Knowledge with Success

PHYSICS

As per the Latest Design of CBSE Question Paper

Remembering & Understanding Based Questions

CBSE Examination Papers-2015 (Solved)

Higher Order Thinking Skills (HOTS)

Application Based Questions

Value Based Questions

Proficiency Exercise

PHYSICS

**Examination Papers
2008–2014**

CONTENT

■ CBSE Examination Paper–2008 (Delhi)	3
■ CBSE Examination Paper–2008 (All India)	37
■ CBSE Examination Paper–2009 (Delhi)	71
■ CBSE Examination Paper–2009 (All India)	103
■ CBSE Examination Paper–2009 (Foreign)	131
■ CBSE Examination Paper–2010 (Delhi)	161
■ CBSE Examination Paper–2010 (All India)	186
■ CBSE Examination Paper–2010 (Foreign)	213
■ CBSE Examination Paper–2011 (Delhi)	239
■ CBSE Examination Paper–2011 (All India)	273
■ CBSE Examination Paper–2011 (Foreign)	303
■ CBSE Examination Paper–2012 (Delhi)	333
■ CBSE Examination Paper–2012 (All India)	358
■ CBSE Examination Paper–2012 (Foreign)	390
■ CBSE Examination Paper–2013 (Delhi)	419
■ CBSE Examination Paper–2013 (All India)	451
■ CBSE Examination Paper–2013 (Foreign)	480
■ CBSE Examination Paper–2014 (Delhi)	507
■ CBSE Examination Paper–2014 (All India)	535
■ CBSE Examination Paper–2014 (Foreign)	567

CBSE EXAMINATION PAPERS

DELHI-2008

Time allowed : 3 hours

Maximum marks : 70

General Instructions:

- (a) All questions are compulsory.
- (b) There are 30 questions in total. Questions 1 to 8 carry one mark each, questions 9 to 18 carry two marks each, questions 19 to 27 carry three marks each and questions 28 to 30 carry five marks each.
- (c) There is no overall choice. However, an internal choice has been provided in one question of two marks, one question of three marks and all three questions of five marks each. You have to attempt only one of the given choices in such questions.
- (d) Use of calculators is not permitted.
- (e) You may use the following values of physical constants wherever necessary:

$$c = 3 \times 10^8 \text{ ms}^{-1}$$

$$h = 6.626 \times 10^{-34} \text{ Js}$$

$$e = 1.602 \times 10^{-19} \text{ C}$$

$$\mu_0 = 4\pi \times 10^{-7} \text{ TmA}^{-1}$$

$$\frac{1}{4\pi\epsilon_0} = 9 \times 10^9 \text{ Nm}^2\text{C}^{-2}$$

$$\text{Boltzmann's constant } k = 1.381 \times 10^{-23} \text{ JK}^{-1}$$

$$\text{Avogadro's number } N_A = 6.022 \times 10^{23} / \text{mole}$$

$$\text{Mass of neutron } m_n = 1.675 \times 10^{-27} \text{ kg}$$

$$\text{Mass of electron } m_e = 9.1 \times 10^{-31} \text{ kg}$$

$$\text{Radius of earth} = 6400 \text{ km}$$

CBSE (Delhi) SET-I

1. What is the direction of the force acting on a charge particle q , moving with a velocity v in a uniform magnetic field \mathbf{B} ?
2. Name the part of the electromagnetic spectrum of wavelength 10^{-2} m and mention its one application.
3. An electron and alpha particle have the same de Broglie wavelength associated with them. How are their kinetic energies related to each other ?
4. A glass lens of refractive index 1.5 is placed in a trough of liquid. What must be the refractive index of the liquid in order to make the lens disappear ?
5. A 500 C charge is at the centre of a square of side 10 cm. Find the work done in moving a charge of 10 C between two diagonally opposite points on the square.
6. State the reason, why heavy water is generally used as a moderator in a nuclear reactor.
7. How does the fringe width of interference fringes change, when the whole apparatus of Young's experiment is kept in a liquid of refractive index 1.3 ?

4 Xam idea Physics—XII

8. The plot of the variation of potential difference across a combination of three identical cells in series, versus current is as shown below. What is the emf of each cell ?

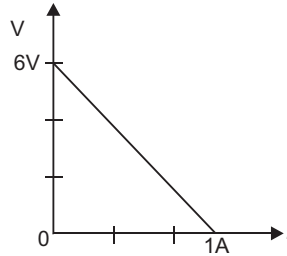

9. Derive the expression for the electric potential at any point along the axial line of an electric dipole ?
 10. Define magnetic susceptibility of a material. Name two elements, one having positive susceptibility and the other having negative susceptibility. What does negative susceptibility signify ?
 11. The oscillating magnetic field in a plane electromagnetic wave is given by

$$B_y = (8 \times 10^{-6}) \sin [2 \times 10^{11} t - 300 x] T$$

- (i) Calculate the wavelength of the electromagnetic wave.
 (ii) Write down the expression for the oscillating electric field.
 12. Prove that an ideal capacitor, in an a.c. circuit does not dissipate power.

OR

Derive an expression for the impedance of an a.c. circuit consisting of an inductor and a resistor.

13. A nucleus ${}_{10}^{23}\text{Ne}$ undergoes β^- -decay and becomes ${}_{11}^{23}\text{Na}$. Calculate the maximum kinetic energy of electrons emitted assuming that the daughter nucleus and anti-neutrino carry negligible kinetic energy.

$$\text{mass of } {}_{10}^{23}\text{Ne} = 22.994466 \text{ u}$$

$$\text{mass of } {}_{11}^{23}\text{Na} = 22.989770 \text{ u}$$

$$1 \text{ u} = 931.5 \text{ MeV} / c^2$$

14. Distinguish between an intrinsic semiconductor and P-type semiconductor. Give reason, why a P-type semiconductor crystal is electrically neutral, although $n_h \neq n_e$?
 15. Draw a ray diagram of a reflecting type telescope. State two advantages of this telescope over a refracting telescope.
 16. A ray of light passing through an equilateral triangular glass prism from air undergoes minimum deviation when angle of incidence is $3/4$ th of the angle of prism. Calculate the speed of light in the prism.
 17. The given inputs A, B are fed to a 2-input NAND gate. Draw the output wave form of the gate.

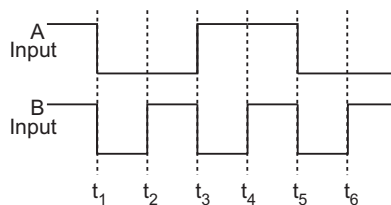

18. A transmitting antenna at the top of a tower has a height of 36 m and the height of the receiving antenna is 49 m. What is the maximum distance between them, for satisfactory communication in the LOS mode ? (Radius of earth = 6400 km).
19. How is a wavefront defined ? Using Huygen's construction draw a figure showing the propagation of a plane wave refracting at a plane surface separating two media. Hence verify Snell's law of refraction.
20. A metallic rod of length l is rotated at a constant angular speed ω , normal to a uniform magnetic field B . Derive an expression for the current induced in the rod, if the resistance of the rod is R .
21. The figure adjoining shows the V - I characteristics of a semiconductor diode.

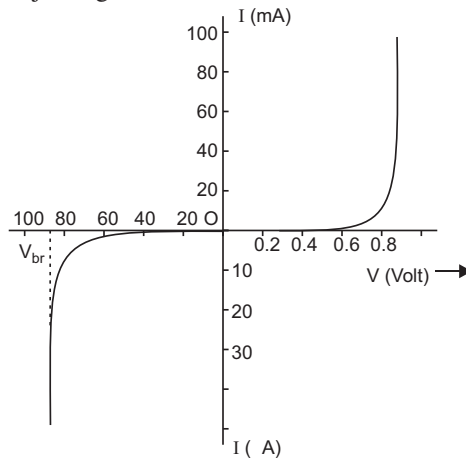

- (i) Identify the semiconductor diode used.
- (ii) Draw the circuit diagram to obtain the given characteristic of this device.
- (iii) Briefly explain how this diode can be used as a voltage regulator.
22. An inductor 200 mH, capacitor 500 μ F, resistor 10 Ω are connected in series with a 100 V, variable frequency a.c. source. Calculate the
- (i) frequency at which the power factor of the circuit is unity.
- (ii) current amplitude at this frequency.
- (iii) Q -factor.
23. Prove that the current density of a metallic conductor is directly proportional to the drift speed of electrons.

OR

- A number of identical cells, n , each of emf E , internal resistance r connected in series are charged by a d.c. source of emf E , using a resistor R .
- (i) Draw the circuit arrangement.
- (ii) Deduce the expressions for (a) the charging current and (b) the potential difference across the combination of the cells.
24. A potentiometer wire of length 1 m is connected to a driver cell of emf 3 V as shown in the figure. When a cell of 1.5 V emf is used in the secondary circuit, the balance point is found to be 60 cm. On replacing this cell and using a cell of unknown emf, the balance point shifts to 80 cm.

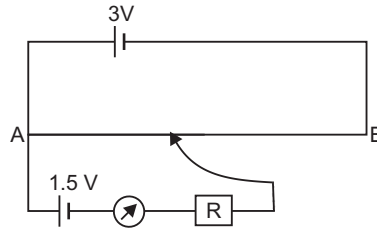

- (i) Calculate unknown emf of the cell.
- (ii) Explain with reason, whether the circuit works, if the driver cell is replaced with a cell of emf 1 V.
- (iii) Does the high resistance R , used in the secondary circuit affect the balance point? Justify our answer.

25. An electromagnetic wave of wavelength λ is incident on a photosensitive surface of negligible work function. If the photo-electrons emitted from this surface have the de-Broglie wavelength λ_1 , prove that $\frac{2mc}{h} \lambda_1^2$.

26. The energy level diagram of an element is given below. Identify, by doing necessary calculations, which transition corresponds to the emission of a spectral line of wavelength 102.7 nm.

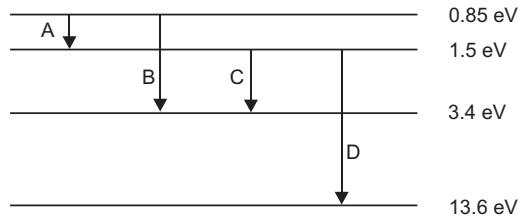

27. Draw a plot of the variation of amplitude versus ω for an amplitude modulated wave. Define modulation index. State its importance for effective amplitude modulation.

28. (a) Using Biot-Savart's law, derive an expression for the magnetic field at the centre of a circular coil of radius R , number of turns N , carrying current I .

(b) Two small identical circular coils marked 1 and 2 carry equal currents and are placed with their geometric axes perpendicular to each other as shown in the figure. Derive an expression for the resultant magnetic field at O .

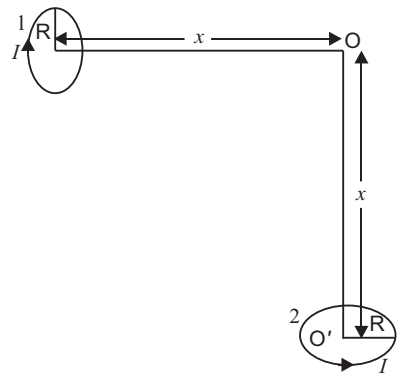

OR

Draw a schematic diagram of a cyclotron. Explain its underlying principle and working, starting clearly the function of the electric and magnetic fields applied on a charged particle.

Deduce an expression for the period of revolution and show that it does not depend on the speed of the charged particle.

29. (a) For a ray of light travelling from a denser medium of refractive index n_1 to a rarer medium of refractive index n_2 , prove that $\frac{n_2}{n_1} \sin i_c$, where i_c is the critical angle of incidence for the media.
- (b) Explain with the help of a diagram, how the above principle is used for transmission of video signals using optical fibres.

OR

- (a) What is plane polarised light? Two polaroids are placed at 90° to each other and the transmitted intensity is zero. What happens when one more polaroid is placed between these two, bisecting the angle between them? How will the intensity of transmitted light vary on further rotating the third polaroid?
- (b) If a light beam shows no intensity variation when transmitted through a polaroid which is rotated, does it mean that the light is unpolarised? Explain briefly.
30. (a) Using Gauss law, derive an expression for the electric field intensity at any point outside a uniformly charged thin spherical shell of radius R and charge density C/m^2 . Draw the field lines when the charge density of the sphere is (i) positive, (ii) negative.
- (b) A uniformly charged conducting sphere of 2.5 m in diameter has a surface charge density of $100 C/m^2$. Calculate the
- (i) charge on the sphere (ii) total electric flux passing through the sphere.

OR

- (a) Derive an expression for the torque experienced by an electric dipole kept in a uniform electric field.
- (b) Calculate the work done to dissociate the system of three charges placed on the vertices of a triangle as shown.

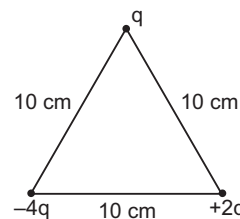

Here $q = 1.6 \times 10^{-10} C$.

CBSE (Delhi) SET-II

Questions different from Set - I

- Name the part of the electromagnetic spectrum of wavelength 10^2 m and mention its one application.
- An electron and alpha particle have the same kinetic energy. How are the de-Broglie wavelengths associated with them related?
- A converging lens of refractive index 1.5 is kept in a liquid medium having same refractive index. What would be the focal length of the lens in this medium?
- How does the angular separation of interference fringes change, in Young's experiment, if the distance between the slits is increased?
- Draw a ray diagram of an astronomical telescope in the normal adjustment position. State two drawbacks of this type of telescope.
- Calculate the distance of an object of height h from a concave mirror of focal length 10 cm, so as to obtain a real image of magnification 2.

13. Draw the output wave form at X , using the given inputs A , B for the logic circuit shown below. Also identify the gate.

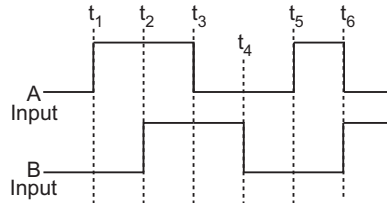
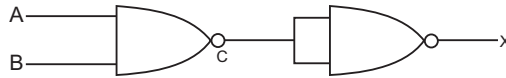

15. Derive an expression for the potential energy of an electric dipole of dipole moment \mathbf{p} in an electric field \mathbf{E} .
18. Prove that an ideal inductor does not dissipate power in an a.c. circuit.

OR

Derive an expression for the self-inductance of a long air-cored solenoid of length l and number of turns N .

19. Define conductivity of a conductor. Explain the variation of conductivity with temperature in (a) good conductors, (b) ionic conductors.
24. How is a wavefront defined ? Using Huygen's construction draw a figure showing the propagation of a plane wave reflecting at the interface of the two media. Show that the angle of incidence is equal to the angle of reflection.
25. A coil of number of turns N , area A , is rotated at a constant angular speed ω , in a uniform magnetic field B , and connected to a resistor R . Deduce expressions for :
- Maximum emf induced in the coil
 - Power dissipation in the coil.

CBSE (Delhi) SET-III

Questions different from Set - I & II

- Name the absorbing material used to control the reaction rate of neutrons in a nuclear reactor.
- State the reason, why two independent sources of light cannot be considered as coherent sources.
- An electron and a proton have the same de Broglie wavelength associated with them. How are their kinetic energy related to each other?
- How does the power of a convex lens vary, if the incident red light is replaced by violet light ?
- Draw a ray diagram of a compound microscope. Write the expression for its magnifying power.
- If the output of a 2 input NOR gate is fed as both inputs A and B to another NOR gate, write down a truth table to find the final output, for all combinations of A , B .

15. The oscillating electric field of an electromagnetic wave is given by:

$$E_y = 30 \sin [2 \times 10^{11} t - 300 x] \text{ Vm}^{-1}$$

- (a) Obtain the value of the wavelength of the electromagnetic wave.
 (b) Write down the expression for the oscillating magnetic field.
16. Obtain the expression for the mutual inductance of a pair of coaxial circular coils of radii r and R ($R > r$) placed with their centres coinciding.
20. The energy levels of an element are given below:

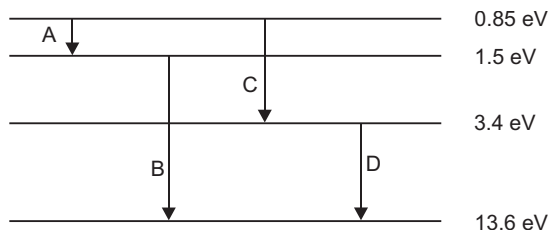

Identify, using necessary calculations, the transition, which corresponds to the emission of a spectral line of wavelength 482 nm:

24. An inductor of unknown value, a capacitor of $100 \mu\text{F}$ and a resistor of 10Ω are connected in series to a 200 V, 50 Hz a.c. source. It is found that the power factor of the circuit is unity. Calculate the inductance of the inductor and the current amplitude.
25. Prove that the current density of a metallic conductor is directly proportional to the drift speed of electrons through the conductor.

OR

Define resistivity of a conductor. Plot a graph showing the variation of resistivity with temperature for a metallic conductor. How does one explain such a behaviour, using the mathematical expression of the resistivity of a material.

26. A metallic rod of length l is rotated at an angular speed ω , normal to a uniform magnetic field B . Derive an expression for the (i) emf induced in the rod (ii) heat dissipation, if the resistance of the rod is R .
-

Solutions

CBSE (Delhi) SET-I

1. Force, $\mathbf{F}_m = q \mathbf{v} \times \mathbf{B}$

Obviously, the force on charged particle is perpendicular to both velocity v and magnetic field \mathbf{B} ?

2. Wavelength 10^{-2} m belongs to **microwaves**. It is used in RADAR.

3. Given

de Broglie wavelength associated with a particle of mass m and energy E is

$$\frac{h}{\sqrt{2mE}} \quad \frac{h}{\sqrt{2m_e E_e}}$$

That is kinetic energy of electron and α -particle are in inverse ratio of these masses.

4. The glass lens will disappear in the liquid if the refractive index of liquid is equal to that of glass *i.e.*, **refractive index of liquid = 1.5**.
5. The points A and B are equidistant from the centre of square where charge $q = 500 \text{ C}$ is located; therefore, points A and B are at the same potential *i.e.*, $V_A = V_B$.

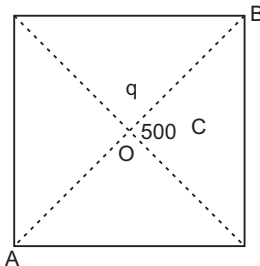

Work done in moving charge $q_0 = 10 \text{ C}$ from A to B is

$$W = q_0 (V_B - V_A) = 0$$

6. The basic principle of mechanics is that momentum transfer is maximum when the mass of colliding particle and target particle are equal. Heavy water has negligible absorption cross-section for neutrons and its mass is small; so heavy water molecules do not absorb fast neutrons; but simply slow them.

7. Fringe width, $\frac{D}{d}$ for same D and d . When the whole apparatus is immersed in a

transparent liquid of refractive index $n = 1.3$, the wavelength decreases to $\frac{\lambda}{n} = \frac{\lambda}{1.3}$. So, **fringe**

width decreases to $\frac{1}{1.3}$ times.

8. Let ϵ be emf and r the internal resistance of each cell. The equation of terminal potential difference

$$V = \epsilon - i r_{\text{int}} \text{ becomes } V = \frac{\epsilon}{3} - i r_{\text{int}} \quad \dots(1)$$

where r_{int} is effective (total) internal resistance.

From fig., when $i = 0$, $V = 6.0 \text{ V}$

From (1),

$$6.0 = \frac{\epsilon}{3} - 0 \quad \frac{\epsilon}{3} = 2 \text{ V}$$

i.e., emf of each cell, $\epsilon = 2 \text{ V}$

9. Electric Potential due to an electric dipole at axial point. Consider an electric dipole AB , having charges $+q$ and $-q$ at points A and B respectively. The separation between the charges is $2l$.

Electric dipole moment, $\mathbf{p} = q \cdot 2l$, directed from $-q$ to $+q$.

Consider a point P on the axis of dipole at a distance r from mid-point O of dipole.

The distance of point P from charge $+q$ is $BP = r - l$

The distance of point P from charge $-q$ is $AP = r + l$

Let V_1 and V_2 be the potentials at P due to charges $-q$ and $+q$ respectively. Then

$$V_1 = \frac{1}{4\pi\epsilon_0} \frac{q}{r+l} \text{ and } V_2 = \frac{1}{4\pi\epsilon_0} \frac{q}{r-l}$$

Resultant potential at P due to dipole

$$\begin{aligned} V &= V_1 - V_2 = \frac{1}{4\pi\epsilon_0} \frac{q}{(r+l)} - \frac{1}{4\pi\epsilon_0} \frac{q}{(r-l)} \\ &= \frac{1}{4\pi\epsilon_0} \cdot q \left[\frac{1}{r+l} - \frac{1}{r-l} \right] = \frac{1}{4\pi\epsilon_0} \cdot q \left[\frac{(r-l) - (r+l)}{(r+l)(r-l)} \right] \\ &= \frac{1}{4\pi\epsilon_0} \frac{q \cdot 2l}{r^2 - l^2} \end{aligned}$$

As $q \cdot 2l = p$ (dipole moment)

$$V = \frac{1}{4\pi\epsilon_0} \frac{p}{r^2 - l^2}$$

If point P is far away from the dipole, then $r \gg l$

$$V = \frac{1}{4\pi\epsilon_0} \frac{p}{r^2}$$

10. Magnetic susceptibility: It is defined as the intensity of magnetisation per unit magnetising field, i.e. $\chi_m = \frac{M}{H}$. It has no unit.

Iron has positive susceptibility while **copper** has negative susceptibility.

Negative susceptibility of a substance signifies that the substance will be repelled by a strong magnet or opposite feeble magnetism induced in the substance.

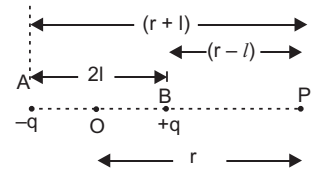

12 Xam idea Physics—XII

11. (i) Standard equation of magnetic field is

$$B_y = B_0 \sin(\omega t - kx) T$$

Comparing this equation with the given equation, we get

$$B_0 = 8 \times 10^{-6} \text{ T}, \quad \omega = 2 \times 10^{11} \text{ rad s}^{-1}, \quad k = \frac{2}{300}$$

wavelength, $\frac{2}{300} = \frac{1}{150} \text{ m}$

(ii) $E_0 = B_0 c = 8 \times 10^{-6} \times 3 \times 10^8 = 2.4 \times 10^3 \text{ Vm}^{-1}$.

According to right hand system of **E**, **B**, **K**, the electric field oscillates along negative Z-axis, so equation is

$$E_z = 2.4 \times 10^3 \sin(2 \times 10^{11} t - 300 x) \text{ Vm}^{-1}$$

12. Power dissipated in a.c. circuit, $P = V_{rms} I_{rms} \cos \phi$ where $\cos \phi = \frac{R}{Z}$

For an ideal capacitor $R = 0$ $\cos \phi = \frac{R}{Z} = 0$

$$P = V_{rms} I_{rms} \cos \phi = V_{rms} I_{rms} \times 0 = 0 \text{ (zero)}.$$

i.e., power dissipated in an ideal capacitor is zero.

OR

Let a circuit contain a resistor of resistance R and an inductor of inductance L connected in series. The applied voltage is $V = V_0 \sin \omega t$. Suppose the voltage across resistor is V_R and that across inductor is V_L . The voltage V_R and current I are in the same phase, while the voltage V_L leads the current by an angle $\frac{\pi}{2}$. Thus, V_R and V_L are mutually perpendicular. The resultant of V_R and V_L is the applied voltage i.e.,

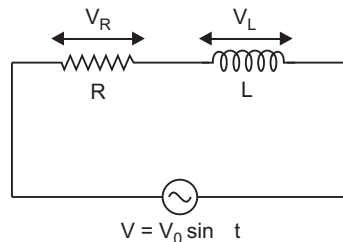

But $V = \sqrt{V_R^2 + V_L^2}$
 where $V_R = Ri$, $V_L = X_L i$ $X_L = \omega L$ is inductive reactance

$$\text{Impedance, } Z = \frac{V}{i} = \sqrt{R^2 + X_L^2} = \sqrt{R^2 + (\omega L)^2}$$

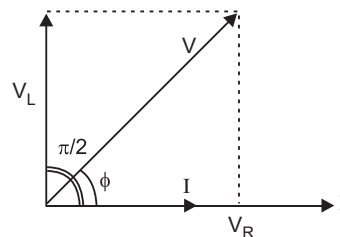

13. The equation of α -decay of ${}^{23}_{10}\text{Ne}$ is

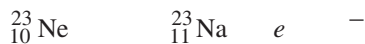

Mass difference, $m = m_N({}^{23}_{10}\text{Ne}) - m_N({}^{23}_{11}\text{Na}) - m_e$

Changing nuclear masses into atomic masses

$$m \quad m \quad m \quad m \quad m \quad m$$

$${}_{10}^{23}\text{Ne} \quad 10m_e \quad {}_{11}^{23}\text{Na} \quad 11m_e \quad m_e$$

$$m({}_{10}^{23}\text{Ne}) \quad m({}_{11}^{23}\text{Na})$$

$$22.994466 \quad 22.989770$$

$$0.004696 \text{ u}$$

$$\text{Maximum K.E., } Q = 0.004696 \text{ u} \times 931.5 \text{ MeV/u}$$

$$4.37 \text{ MeV}$$

14.

	Intrinsic semiconductor		<i>p</i> -type semiconductor
(i)	It is a semiconductor in pure form.	(i)	It is a semiconductor doped with <i>p</i> -type (like Al, In) impurity.
(ii)	Intrinsic charge carriers are electrons and holes with equal concentration.	(ii)	Majority charge carriers are holes and minority charge carriers are electrons.
(iii)	Current due to charge carriers is feeble (of the order of μA).	(iii)	Current due to charge carriers is significant (of the order of mA).

P-type semiconductor is electrically neutral because every atom, whether it is of pure semiconductor (Ge or Si) or of impurity (Al) is electrically neutral.

15.

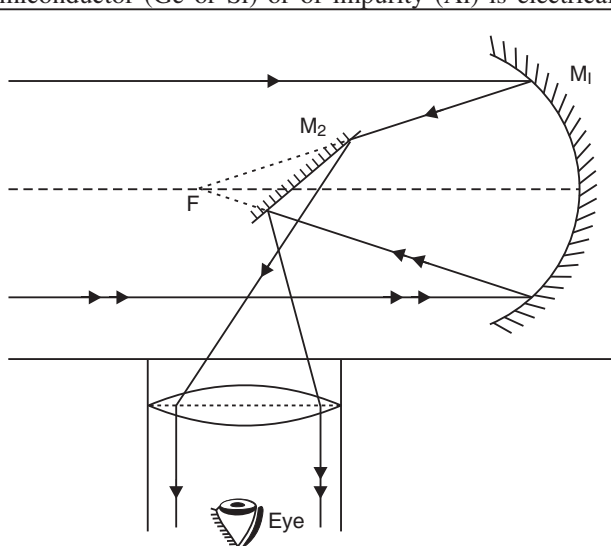

Advantages: (i) It is free from chromatic aberration.

(ii) Its resolving power is greater than refracting telescope due to larger aperture of mirror.

14 Xam idea Physics—XII

16. Given $A = 60^\circ$, $i = \frac{3}{4}A = \frac{3}{4} \times 60 = 45^\circ$

For minimum deviation $i_1 = i_2 = i$ and $r_1 = r_2 = \frac{A}{2} = 30^\circ$

Refractive index of prism, $n = \frac{\sin i}{\sin r}$

$$= \frac{\sin 45^\circ}{\sin 30^\circ} = \frac{1/\sqrt{2}}{1/2} = \sqrt{2} \quad \mathbf{1.41}$$

Speed of light in prism, $v = \frac{c}{n} = \frac{3 \times 10^8}{1.41} = 2.13 \times 10^8 \text{ ms}^{-1}$.

17. The output of NAND gate with inputs A and B is

$$Y = \overline{AB}$$

i.e., output is obtained if either or both inputs are zero.

Accordingly the output waveform $Y = \overline{AB}$ is shown in fig.

i.e., output is zero between intervals 0 to t_1 and t_4 to t_5 and in all other intervals it is '1'.

The output waveform is shown in fig.

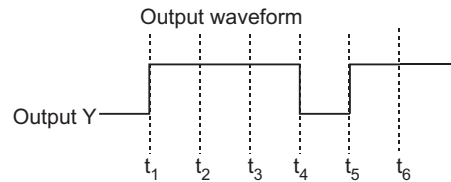

18. Given $h_T = 36 \text{ m}$, $h_R = 49 \text{ m}$, and $R_e = 6400 \text{ km} = 6.4 \times 10^6 \text{ m}$.

Maximum LOS distance, $d_m = \sqrt{2R_e h_T} + \sqrt{2R_e h_R}$

$$= \sqrt{2R_e} (\sqrt{h_T} + \sqrt{h_R}) = \sqrt{2 \times 6.4 \times 10^6} (\sqrt{36} + \sqrt{49})$$

$$= 3578 \times 10^3 (6 + 7) = 3578 \times 10^3 \times 13 \text{ m}$$

$$= 46.5 \times 10^3 \text{ m} = \mathbf{46.5 \text{ km}}$$

19. **Wavefront:** A wavefront is a locus of all particles of medium vibrating in the same phase.

Proof of Snell's law of Refraction using Huygen's wave theory: When a wave starting from one homogeneous medium enters the another homogeneous medium, it is deviated from its path. This phenomenon is called **refraction**. In transversing from first medium to another medium, the frequency of wave remains unchanged but its speed and the wavelength both are changed. Let XY be a surface separating the two media '1' and '2'. Let v_1 and v_2 be the speeds of waves in these media.

Suppose a plane wavefront AB in first medium is incident obliquely on the boundary surface XY and its end A touches the surface at A at time $t = 0$ while the other end B reaches the surface at point B' after time-interval t . Clearly $BB' = v_1 t$. As the wavefront AB advances, it strikes the points between A and B of boundary surface. According to Huygen's principle, secondary spherical wavelets originate from these points, which travel with speed v_1 in the first medium and speed v_2 in the second medium.

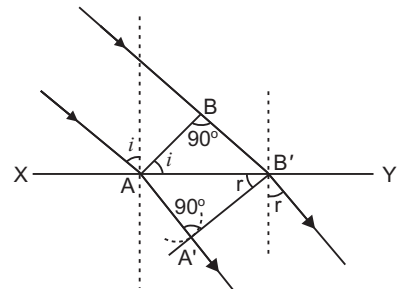

First of all secondary wavelet starts from A, which traverses a distance AA (v_2t) in second medium in time t . In the same time-interval t , the point of wavefront traverses a distance BB (v_1t) in first medium and reaches B, from, where the secondary wavelet now starts. Clearly $BB = v_1t$ and $AA = v_2t$.

Assuming A as centre, we draw a spherical arc of radius AA (v_2t) and draw tangent BA on this arc from B. As the incident wavefront AB advances, the secondary wavelets start from points between A and B, one after the other and will touch AA simultaneously. According to Huygen's principle AA is the new position of wavefront AB in the second medium. Hence AA **will be the refracted wavefront**.

Let the incident wavefront AB and refracted wavefront AA make angles i and r respectively with refracting surface XY.

In right-angled triangle ABB, $\angle ABB = 90^\circ$

$$\sin i = \frac{BB}{AB} = \frac{v_1t}{AB} \quad \dots(1)$$

Similarly in right-angled triangle AA'B, $\angle AA'B = 90^\circ$

$$\sin r = \frac{AA'}{AB} = \frac{v_2t}{AB} \quad \dots(2)$$

Dividing equation (1) by (2), we get

$$\frac{\sin i}{\sin r} = \frac{v_1}{v_2} = \text{constant} \quad \dots(3)$$

The ratio of sine of angle of incidence and the sine of angle of refraction is a constant and is equal to the ratio of velocities of waves in the two media. This is the second law of refraction, and is called the Snell's law.

20. Consider a metallic rod OA of length l , which is rotating with angular velocity ω in a uniform magnetic field B , the plane of rotation being perpendicular to the magnetic field. A rod may be supposed to be formed of a large number of small elements. Consider a small element of length dx at a distance x from centre. If v is the linear velocity of this element, then area swept by the element per second $v dx$

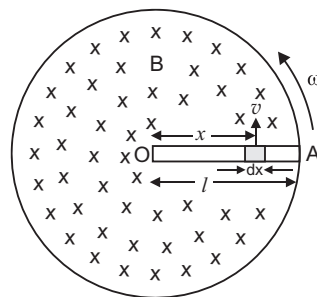

The emf induced across the ends of element

$$d\epsilon = B \frac{dA}{dt} = B v dx$$

But $v = \omega x$

$$d\epsilon = B \omega x dx$$

The emf induced across the rod

$$\begin{aligned} \epsilon &= \int_0^l B \omega x dx = B \omega \int_0^l x dx \\ &= B \omega \left[\frac{x^2}{2} \right]_0^l = B \omega \frac{l^2}{2} = \frac{1}{2} B \omega l^2 \end{aligned}$$

Current induced in rod $I = \frac{\epsilon}{R} = \frac{1}{2} \frac{B \omega l^2}{R}$

21. (i) Semiconductor diode used is Zener diode (but the voltages quoted in fig. are much more than actual values V_{br} is usually < 6 V).
 (ii) The circuit diagram for reverse characteristics of Zener diode is shown in fig.
 (iii) Zener diode as a Voltage Regulator
 The Zener diode makes its use as a voltage regulator due to the following property :

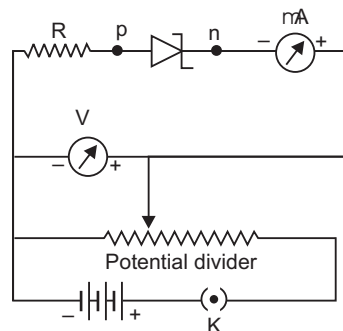

When a Zener diode is operated in the breakdown region, the voltage across it remains practically constant for a large change in the current.

A simple circuit of a voltage regulator using a Zener diode is shown in the Fig. The Zener diode is connected across load such that it is reverse biased.

The series resistance R absorbs the output voltage fluctuations so as to maintain constant voltage across the load.

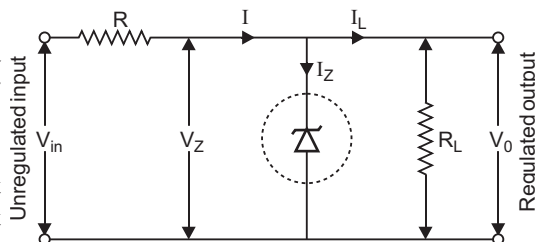

If the input dc voltage increases, the current through R and Zener diode also increases. So, voltage drop across R increases, without any change in the voltage across zener diode.

22. Given $L = 200 \text{ mH} = 200 \times 10^{-3} \text{ H}$, $C = 500 \text{ F} = 500 \times 10^{-6} \text{ F}$,

$$R = 10 \Omega, V_{rms} = 100 \text{ V}$$

- (i) Angular (resonant) frequency ω_r at which power factor of the circuit is unity, is given by

$$\omega_r L = \frac{1}{\omega_r C} \quad \omega_r = \frac{1}{\sqrt{LC}} = \frac{1}{\sqrt{200 \times 10^{-3} \times 500 \times 10^{-6}}} = 100 \text{ rad s}^{-1}$$

Linear Resonant Frequency

$$f_r = \frac{\omega_r}{2\pi} = \frac{100}{2 \times 3.14 \times 6.28} \text{ Hz} = 15.9 \text{ Hz}$$

- (ii) At resonant frequency f_r impedance, $Z = R$

$$\text{Current amplitude, } I_0 = \frac{V_0}{Z} = \frac{V\sqrt{2}}{R} = \frac{100\sqrt{2}}{10} = 10\sqrt{2} \text{ A} = 14.1 \text{ A}$$

- (iii) Q -factor $= \frac{\omega_r L}{R} = \frac{100 \times 200 \times 10^{-3}}{10} = 2$

23. Consider a uniform metallic wire XY of length l and cross-sectional area A . A potential difference V is applied across the ends X and Y of the wire. This causes an electric field at each point of the wire of strength

$$E = \frac{V}{l} \quad \dots(1)$$

Due to this electric field, the electrons gain a drift velocity v_d opposite to direction of electric field. If q be the charge passing through the cross-section of wire in t seconds, then

Current in wire $I = \frac{q}{t}$... (2)

The distance traversed by each electron in time t

= average velocity \times time $v_d t$

If we consider two planes P and Q at a distance $v_d t$ in a conductor, then the total charge flowing in time t will be equal to the total charge on the electrons present within the cylinder PQ .

The volume of this cylinder = cross sectional area \times height

$A v_d t$

If n is the number of free electrons in the wire per unit volume, then the number of free electrons in the cylinder $n(A v_d t)$

If charge on each electron is e ($e = 1.6 \times 10^{-19}$ C), then the total charge flowing through a cross-section of the wire

$q = (nA v_d t)(e) = neAv_d t$... (3)

Current flowing in the wire,

$I = \frac{q}{t} = \frac{neAv_d t}{t}$

i.e., current $I = neAv_d$... (4)

This is the relation between electric current and drift velocity. Negative sign shows that the direction of current is opposite to the drift velocity.

Numerically $I = neAv_d$... (5)

Current density, $J = \frac{I}{A} = nev_d$

$J = v_d \cdot$

OR

- (i) The circuit arrangement is shown in fig.
- (ii) Applying Kirchoff's second law to the circuit $abcda$

$n \cdot I(nr) - IR = 0$
 $I = \frac{n}{R - nr}$

(a) Charging current, $I = \frac{n}{R - nr}$... (a)

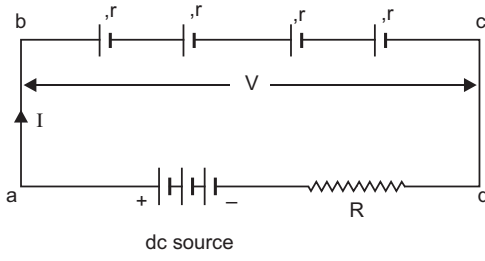

(b) Potential difference across the combination V is given by

$V = IR = 0$
 $V = IR$

$$V = \frac{(R + nr)}{R + nr} \quad V = \frac{(R + nr)}{R + nr} \frac{n}{n}$$

$$V = \frac{(R + nr - 1) n}{R + nr}$$

24. (i) Unknown emf \mathcal{E}_2 is given by

$$\frac{\mathcal{E}_2}{\mathcal{E}_1} = \frac{l_2}{l_1} \quad \mathcal{E}_2 = \frac{l_2}{l_1} \mathcal{E}_1$$

Given $\mathcal{E}_1 = 1.5 \text{ V}, l_1 = 60 \text{ cm}, l_2 = 80 \text{ cm}$

$$\mathcal{E}_2 = \frac{80}{60} \times 1.5 \text{ V} = 2.0 \text{ V}$$

(ii) The circuit will not work if emf of driver cell is 1 V (less than that of cell in secondary circuit), because total voltage across wire AB is 1 V which cannot balance the voltage 1.5 V.

(iii) No, since at balance point no current flows through galvanometer G i.e., cell remains in open circuit.

25. Kinetic energy of electrons, E_k = energy of photon of e.m. wave

$$\frac{hc}{\lambda} \quad \dots(1)$$

de Broglie wavelength, $\lambda = \frac{h}{\sqrt{2mE_k}}$ or $\frac{2}{\lambda} = \frac{h^2}{2mE_k}$

Using (1), we get

$$\frac{2}{\lambda} = \frac{h^2}{2m \frac{hc}{\lambda}} = \frac{2mc}{h} \quad \frac{2}{\lambda}$$

26. $E = \frac{hc}{\lambda} = \frac{6.6 \times 10^{-34} \times 3 \times 10^8}{102.7 \times 10^{-9}} \text{ J}$

$$= \frac{6.6 \times 10^{-34} \times 3 \times 10^8}{102.7 \times 10^{-9} \times 1.6 \times 10^{-19}} \text{ eV} = \frac{66 \times 3000}{1027 \times 16} = 12.04 \text{ eV}$$

Now, $E = 13.6 \left(\frac{1}{50} - \frac{1}{12} \right) \text{ eV}$

Hence, transition shown by arrow D corresponds to emission of 102.7 nm.

27. Plot of variation of amplitude versus ω for amplitude modulated wave is shown in fig.

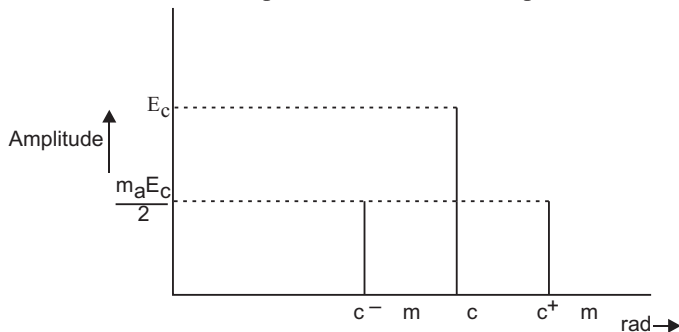

Modulation Index: The ratio of amplitude of modulating signal to the amplitude of carrier wave is called modulation index *i.e.*,

$$m_a = \frac{E_m}{E_c}$$

For effective amplitude modulation the modulation index determines the distortions, so its value is kept 1 for avoiding distortions.

28. (a) Biot Savart Law

It states that the magnetic field strength (dB) produced due to a current element (of current I and length dl) at a point having position vector r relative to current element is

$$dB = \frac{\mu_0}{4\pi} \frac{I dl \times r}{r^3}$$

where μ_0 is permeability of free space. Its value is

$$\mu_0 = 4\pi \times 10^{-7} \text{ Wb/A-m.}$$

The magnitude of magnetic field is

$$dB = \frac{\mu_0}{4\pi} \frac{I dl \sin \theta}{r^2}$$

where θ is the angle between current element $I dl$ and position vector r .

The direction of magnetic field dB is perpendicular to the plane containing $I dl$ and r .

Magnetic Field at the centre of circular loop: Consider a circular coil of radius R carrying current I in anticlockwise direction. Say, O is the centre of coil, at which magnetic field is to be computed. The coil may be supposed to be formed of a large number of current elements. Consider a small current element 'ab' of length l . According to Biot Savart law the magnetic field due to current element 'ab' at centre O is

$$B = \frac{\mu_0}{4\pi} \frac{I l \sin \theta}{R^2}$$

where θ is angle between current element ab and the line joining the element to the centre O . Here $\theta = 90^\circ$, because current element at each point of circular path is perpendicular to the radius. Therefore magnetic field produced at O , due to current element ab is

$$B = \frac{\mu_0}{4\pi} \frac{I l}{R^2}$$

According to Maxwell's right hand rule, the direction of magnetic field at O is upward, perpendicular to the plane of coil. The direction of magnetic field due to all current elements is the same. Therefore the resultant magnetic field at the centre will be the sum of magnetic fields due to all current elements. Thus

$$B = \int dB = \int \frac{\mu_0}{4\pi} \frac{I l}{R^2} = \frac{\mu_0}{4\pi} \frac{I}{R^2} \int l$$

But $\int l$ total length of circular coil $= 2\pi R$ (for one-turn)

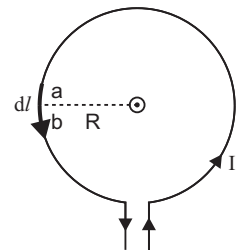
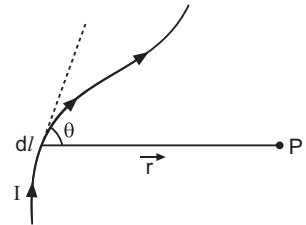

$$B = \frac{\mu_0 I}{4 R^2} \cdot 2 R$$

or
$$B = \frac{\mu_0 I}{2R}$$

If the coil contains N -turns, then $l = N \cdot 2 R$

$$B = \frac{\mu_0 I}{4 R^2} \cdot N \cdot 2 R \quad \text{or} \quad B = \frac{\mu_0 NI}{2R}$$

Here current in the coil is anticlockwise and the direction of magnetic field is perpendicular to the plane of coil upward; but if the current in the coil is clockwise, then the direction of magnetic field will be perpendicular to the plane of coil downward.

(b) Magnetic field due to coil 1 at point O

$$B_1 = \frac{\mu_0 IR^2}{2(R^2 + x^2)^{3/2}} \text{ along } OC_1$$

Magnetic field due to coil 2 at point O

$$B_2 = \frac{\mu_0 IR^2}{2(R^2 + x^2)^{3/2}} \text{ along } C_2O$$

Both B_1 and B_2 are mutually perpendicular, so the net magnetic field at O is

$$B = \sqrt{B_1^2 + B_2^2} = \sqrt{2} B_1 \quad (\text{as } B_1 = B_2)$$

$$= \sqrt{2} \frac{\mu_0 IR^2}{2(R^2 + x^2)^{3/2}}$$

As $R = x$

$$B = \frac{\sqrt{2} \mu_0 IR^2}{2 \cdot x^3} = \frac{\mu_0}{4} \frac{2\sqrt{2} \cdot \mu_0 I (R^2)}{x^3}$$

$$= \frac{\mu_0}{4} \frac{2\sqrt{2} \mu_0 IA}{x^3}$$

where $A = R^2$ is area of loop.

$$\tan \theta = \frac{B_2}{B_1}$$

$$\tan \theta = 1 \quad (\because B_2 = B_1)$$

$$\theta = 45^\circ$$

B is directed at an angle 45° with the direction of magnetic field B_1 .

OR

(a) **Cyclotron:** The cyclotron, devised by Lawrence and Livingston, is a device for accelerating ions to high speed by the repeated application of accelerating potentials.

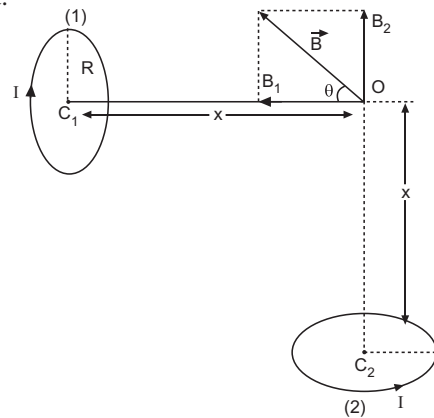

Principle: The positive ions produced from a source are accelerated. Due to the presence of perpendicular magnetic field the ion will move in a circular path. The phenomenon is continued till the ion reaches at the periphery where an auxiliary negative electrode (deflecting plate) deflects the accelerated ion on the target to be bombarded.

Expression for K.E. attained:

If R be the radius of the path and v_{\max} the velocity of the ion when it leaves the periphery, then

$$v_{\max} = \frac{qBR}{m}$$

The kinetic energy of the ion when it leaves the apparatus is,

$$K.E. = \frac{1}{2} m v_{\max}^2 = \frac{q^2 B^2 R^2}{2m}$$

When charged particle crosses the gap between dees it gains KE qV

In one revolution, it crosses the gap twice,

therefore if it completes n -revolutions before emerging the dees, the kinetic energy gained

$$\text{Thus } K.E. = \frac{2nqV}{2m} = 2nqV$$

Working: The principle of action of the apparatus is shown in fig. The positive ions produced from a source S at the centre are accelerated by a dee which is at negative potential at that moment. Due to the presence of perpendicular magnetic field the ion will move in a circular path inside the dees. The magnetic field and the frequency of the applied voltages are so chosen that as the ion comes out of a dee, the dees change their polarity (positive becoming negative and vice-versa) and the ion is further accelerated and moves with higher velocity along a circular path of greater radius. The phenomenon is continued till the ion reaches at the periphery of the dees where an auxiliary negative electrode (deflecting plate) deflects the accelerated ion on the target to be bombarded.

The function of electric field is to accelerate the charged particle and so to impart energy to the charged particle.

The function of magnetic field is to provide circular path to charged particle and so to provide the location where charged particle is capable of gaining energy from electric field.

Expression for Period of Revolution and Frequency:

Suppose the positive ion with charge q moves in a dee with a velocity v , then,

$$qvB = \frac{mv^2}{r} \quad \text{or} \quad r = \frac{mv}{qB} \quad \dots(1)$$

where m is the mass and r the radius of the path of ion in the dee and B is the strength of the magnetic field.

The angular velocity of the ion is given by,

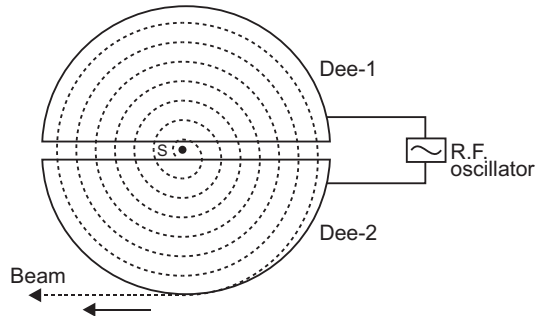
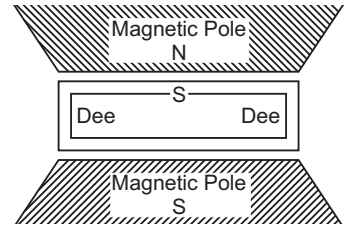

$$\frac{v}{r} = \frac{qB}{m} \text{ (from eq. 1)} \quad \dots(2)$$

The time taken by the ion in describing a semi-circle, *i.e.*, in turning through an angle π is,

$$t = \frac{m}{Bq} \quad \dots(3)$$

$$\frac{T}{2} = t = \frac{m}{qB} \quad \dots(4)$$

or $T = \frac{2m}{qB} \quad \dots(5)$

This is the expression for period of revolution.

Clearly the period of revolution is independent of speed of particle.

29. (a) Snell's laws is $\frac{\sin i}{\sin r} = \frac{n_2}{n_1} \quad \dots(1)$

Critical angle is the angle of incidence in denser medium for which angle of refraction in rarer medium is 90° *i.e.*,

$$i = i_c, \quad r = 90$$

From (1)

$$\frac{\sin i_c}{\sin 90} = \frac{n_2}{n_1} \quad \sin i_c = \frac{n_2}{n_1}$$

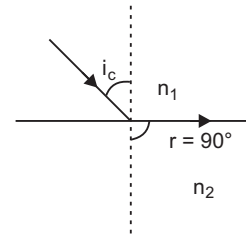

(b) **Transmission of video signals using optical fibre.**

An optical fibre is a device based on total internal reflection by which a light signal may be transmitted from one place to another with a negligible loss of energy. It is a very long and thin pipe of quartz ($n = 1.7$) of thickness nearly 10^{-4} m coated all around with a material of refractive index 1.5. A large number of such fibres held together form a *light pipe* and are used for communication of light signals.

When a light ray is incident on one end at a small angle of incidence, it suffers refraction from air to quartz and strikes the quartz-coating interface at an angle more than the critical angle and so suffers total internal reflection and strikes the opposite face again at an angle greater than critical angle and so again suffers total internal reflection. Thus the ray within the fibre suffers multiple total internal reflections and finally strikes the other end at an angle less than critical angle for quartz-air interface and emerges in air.

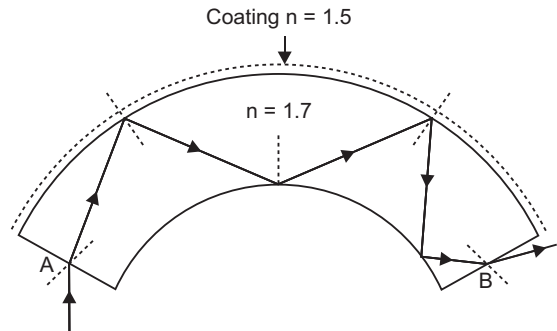

As there is no loss of energy in total internal reflection, the light signal is transmitted by this device without any appreciable loss of energy.

OR

- (a) **Plane Polarised Light:** The light having vibrations of electric field vector in only one direction perpendicular to the direction of propagation of light is called plane polarised light.

The unpolarised and polarised light is represented as

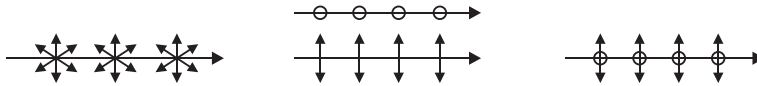

- (a) Unpolarised light (b) Polarised light (c) Partially polarised light

If ordinary unpolarised light of intensity I_0 is incident on first polaroid (A , say)

Intensity of light transmitted from first polaroid is $I_0 \frac{I_0}{2}$

Given angle between transmission axes of two polaroids A and B is initially 90° .

According to Malus law, intensity of light transmitted from second polaroid (B , say) is

$$I = I_0 \cos^2 90 = 0$$

When one more polaroid (C say) is placed between A and B making an angle of 45° with the transmission axis of either of polaroids, then intensity of light transmitted from A is

$$I_A = \frac{I_0}{2} = I_0$$

Intensity of light transmitted from C is

$$I_C = I_0 \cos^2 45 = \frac{I_0}{2}$$

Intensity of light transmitted from polaroid B is

$$I_B = I_C \cos^2 45 = \frac{I_0}{2} \cdot \frac{1}{2} = \frac{I_0}{4}$$

This means that the intensity becomes one-fourth of intensity of light that is transmitted from first polaroid.

On further rotating the polaroid C such that if angle between their transmission axes increases, the intensity decreases and if angle decreases, the intensity increases.

- (b) Yes, the incident light (of intensity I_0) is unpolarised.

Reason: If incident light is unpolarised, the intensity of transmitted light through a polaroid is always $I_0 / 2$, which is constant.

But if incident light is polarised, the intensity variation $I = I_0 \cos^2 \theta$, necessarily takes place.

- 30. (a) Electric field intensity at a point outside a uniformly charged thin spherical shell:**

Consider a uniformly charged thin spherical shell of radius R carrying charge Q . To find the electric field outside the shell, we consider a spherical Gaussian surface of radius r ($r > R$),

concentric with given shell. If \mathbf{E} is electric field outside the shell, then by symmetry electric field strength has same magnitude E_0 on the Gaussian surface and is directed radially outward. Also the directions of normal at each point is radially outward, so angle between

\mathbf{E}_i and $d\mathbf{S}$ is zero at each point. Hence, electric flux through Gaussian surface

$$\oint_S \vec{E} \cdot d\vec{S}$$

$$\oint E_0 dS \cos 0 = E_0 \cdot 4\pi r^2$$

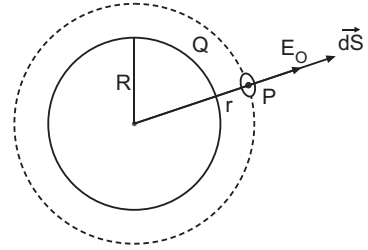

Now, Gaussian surface is outside the given charged shell, so charge enclosed by Gaussian surface is Q .

Hence, by Gauss's theorem

$$\oint_S E_0 dS = \frac{1}{\epsilon_0} \text{charge enclosed}$$

$$E_0 \cdot 4\pi r^2 = \frac{1}{\epsilon_0} Q$$

$$E_0 = \frac{1}{4\pi \epsilon_0} \frac{Q}{r^2}$$

Thus, *electric field outside a charged thin spherical shell is the same as if the whole charge Q is concentrated at the centre.*

If σ is the surface charge density of the spherical shell, then

$$Q = 4\pi R^2 \sigma$$

$$E_0 = \frac{1}{4\pi \epsilon_0} \frac{4\pi R^2 \sigma}{r^2} = \frac{R^2}{r^2} \sigma$$

The electric field lines are shown in the fig. For a positively charged shell, the field lines are directed radially in outward direction and for negatively charged shell, these are directed in radially inward direction.

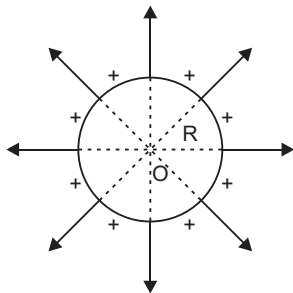

(a) Positively charged shell

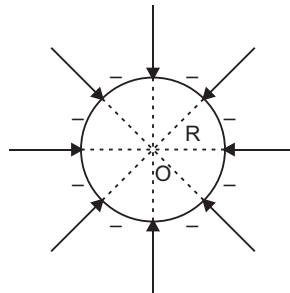

(a) Negatively charged shell

(b) Given, $100 \text{ C/m}^2 = 100 \times 10^{-6} \text{ C/m}^2$.

Diameter, $D = 2R = 2.5 \text{ m}$

(i) Charge on sphere, $Q = \sigma \cdot 4\pi R^2 = \sigma \cdot (2R)^2$

$$(100 \times 10^{-6} \text{ C/m}^2) \cdot 3.14 \cdot (2.5 \text{ m})^2$$

$$19.625 \times 10^{-4} \text{ C}$$

$$1.96 \times 10^{-3} \text{ C} = \mathbf{1.96 \text{ mC}}$$

(ii) Electric flux passing through the sphere

$$\frac{1}{\epsilon_0} (Q) = \frac{1}{8.86 \times 10^{-12}} (1.96 \times 10^{-3})$$

$$= 2.21 \times 10^8 \text{ Nm}^2 \text{ C}^{-1}$$

OR

(a) Consider an electric dipole placed in a uniform electric field of strength E in such a way that its dipole moment

\mathbf{p} makes an angle θ with the direction of \mathbf{E} . The charges of dipole are $+q$ and $-q$ at separation $2l$ the dipole moment of electric dipole,

$$\mathbf{p} = q \cdot 2l \quad \dots(1)$$

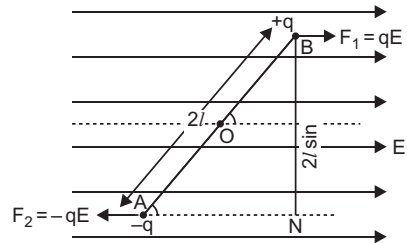

Force: The force on charge $+q$ is, $\mathbf{F}_1 = q\mathbf{E}$, along the

direction of field \mathbf{E}

The force on charge $-q$ is, $\mathbf{F}_2 = -q\mathbf{E}$, opposite to the direction of field \mathbf{E}

Obviously forces \mathbf{F}_1 and \mathbf{F}_2 are equal in magnitude but opposite in direction; hence net force on electric dipole in uniform electric field is

$$\mathbf{F} = \mathbf{F}_1 + \mathbf{F}_2 = q\mathbf{E} - q\mathbf{E} = 0 \text{ (zero)}$$

As net force on electric dipole is zero, so dipole does not undergo any translatory motion.

Torque : The forces \mathbf{F}_1 and \mathbf{F}_2 form a couple (or torque) which tends to rotate and align the dipole along the direction of electric field. This couple is called the torque and is denoted by τ .

torque = magnitude of one force \times perpendicular distance between lines of action of forces

$$\tau = qE (BN) = qE (2l \sin \theta)$$

$$= (q \cdot 2l) E \sin \theta$$

$$\tau = pE \sin \theta \quad \text{[using (1)]} \quad \dots(2)$$

Clearly, the magnitude of torque depends on orientation (θ) of the electric dipole relative to electric field. Torque (τ) is a vector quantity whose direction is perpendicular to both \mathbf{p} and \mathbf{E} .

$$\tau = \mathbf{p} \times \mathbf{E} \quad \dots(3)$$

Thus, if an electric dipole is placed in an electric field in oblique orientation, it experiences no force but experiences a torque. The torque tends to align the dipole moment along the direction of electric field.

Maximum Torque: For maximum torque $\sin \theta$ should be the maximum. As the maximum value of $\sin \theta$ is 1 when $\theta = 90^\circ$

$$\text{Maximum Torque, } \tau_{\text{max}} = pE$$

(b) Potential energy of system *i.e.*, work done to assemble the system of charges

$$U = \frac{1}{4\pi\epsilon_0} \left[\frac{q \cdot (4q)}{0.10} + \frac{q \cdot (2q)}{0.10} + \frac{(4q) \cdot (2q)}{0.10} \right]$$

$$= \frac{1}{4\pi\epsilon_0} \left[\frac{10q^2}{0.10} + \frac{1}{4\pi\epsilon_0} (100q^2) \right]$$

$$= 9 \times 10^9 \times 100 \times (1.6 \times 10^{-10})^2 \times 2.3 \times 10^8 \text{ J}$$

Work done to dissociate the system of charges

$$W = U = 2.3 \times 10^8 \text{ J}$$

CBSE (Delhi) SET-II

1. Wavelength 10^2 m belongs to radio-waves. This is used to broadcast radio programmes to long distances.

2. $p = \frac{h}{m\lambda} \implies m\lambda = \frac{h}{p}$

$$\text{Kinetic energy, } E_k = \frac{1}{2}mv^2 = \frac{1}{2}m \left(\frac{h}{m\lambda} \right)^2$$

$$= \frac{1}{2} \frac{h^2}{m\lambda^2}$$

$$\implies \lambda = \frac{1}{\sqrt{2mE_k}} \frac{h}{\sqrt{mE_k}}$$

Since $m = m_e$

$$\lambda = \frac{h}{\sqrt{2m_e E_k}} = \frac{6.626 \times 10^{-34}}{\sqrt{2 \times 9.1 \times 10^{-31} \times 1.5}}$$

$$= \frac{6.626 \times 10^{-34}}{\sqrt{2.73 \times 10^{-30}}} = \frac{6.626 \times 10^{-34}}{1.65 \times 10^{-15}} = 4.01 \times 10^{-19} \text{ m}$$

3. The focal length of lens in a liquid-medium is given by

$$\frac{1}{f_l} = (n_g - 1) \left(\frac{1}{R_1} - \frac{1}{R_2} \right)$$

$$\frac{1}{f_l} = \frac{n_g}{n_l} - 1 \implies \frac{1}{R_1} - \frac{1}{R_2} = \frac{n_l}{n_g} (1 - \frac{1}{f_l})$$

Given $n_l = n_g = 1.5$

$$\frac{1}{f_l} = 0 \implies f_l = \infty$$

i.e., focal length of converging lens is **infinity** *i.e.*, glass lens behaves as a glass plate.

6. Angular separation of interference fringes in Young's experiment.

$$\frac{\Delta D}{d}$$

If distance between the slits 'd' is increased, the angular separation **decreases**.

11.

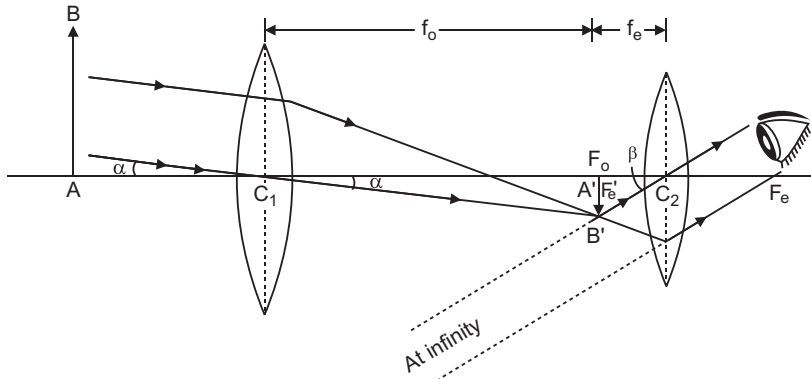

Draw backs:

- (i) It is not free from chromatic aberration.
- (ii) The image formed is inverted and fainter.

12. Given focal length $f = 10 \text{ cm}$, $u = ?$

magnification $m = \frac{v}{u} = 2 \quad v = 2u$

From mirror formula $\frac{1}{f} = \frac{1}{v} + \frac{1}{u}$, we have

$$\frac{1}{10} = \frac{1}{2u} + \frac{1}{u}$$

$$\frac{3}{2u} = \frac{1}{10}$$

$$u = \frac{10 \times 3}{2} = \mathbf{15 \text{ cm}}$$

13. Output of first NOR gate

$$\begin{aligned} \text{Output } X &= \overline{\overline{AB}} \\ &= \overline{C} \\ &= \overline{AB} \end{aligned}$$

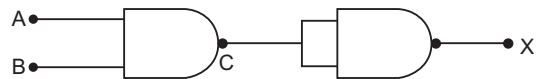

This is AND operation. Therefore, the output is 1 when both inputs are 1. Accordingly the waveform output is shown in figure.

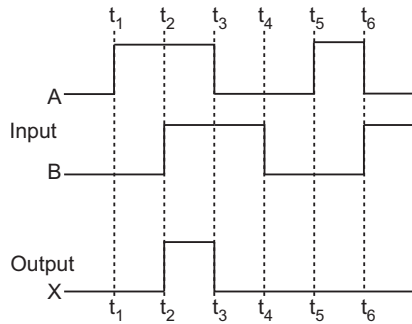

15. The potential energy of an electric dipole of an electric field is defined as the work done in bringing the dipole from infinity to its present position in the electric field.

Suppose the dipole is brought from infinity and placed at orientation with the direction of electric field. The work done in this process may be supposed to be done in two parts.

- (i) The work done (W_1) in bringing the dipole perpendicular to electric field from infinity.
- (ii) Work done (W_2) in rotating the dipole such that it finally makes an angle from the direction of electric field.

(i) Let us suppose that the electric dipole is brought from infinity in the region of a uniform electric field such that its dipole moment \mathbf{p} always remains perpendicular to electric field. The electric forces on charges $+q$ and $-q$ are qE and qE , along the field direction and opposite to field direction respectively. As charges $+q$ and $-q$ traverse equal distance under equal and opposite forces; therefore, net work done in bringing the dipole in the region of electric field perpendicular to field-direction will be zero, i.e., $W_1 = 0$.

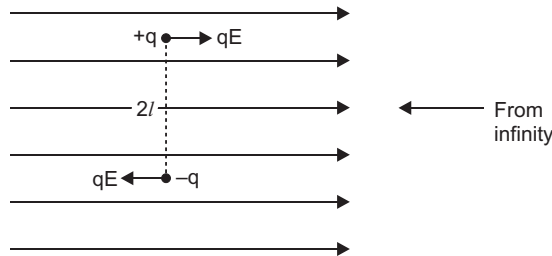

(ii) Now the dipole is rotated and brought to orientation making an angle with the field direction (i.e., $\theta_1 = 90^\circ$ and $\theta_2 = 0^\circ$), therefore, work done

$$W_2 = pE(\cos \theta_1 - \cos \theta_2) = pE(\cos 90^\circ - \cos 0^\circ) = -pE \cos 0^\circ = -pE$$

Total work done in bringing the electric dipole from infinity, i.e., Electric potential energy of electric dipole.

$$U = W_1 + W_2 = 0 - pE \cos \theta = -pE \cos \theta$$

In vector form $U = -\mathbf{p} \cdot \mathbf{E}$... (1)

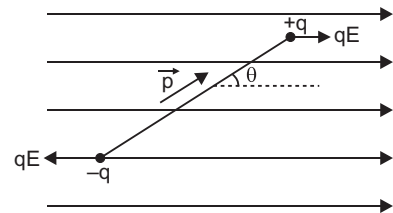

18. The power $P = V_{rms} i_{rms} \cos \phi$

where $\cos \phi = \frac{R}{Z}$; For ideal inductor $R = 0$, $\cos \phi = \frac{R}{Z} = 0$

$P = V_{rms} i_{rms} \cos \phi = 0$ i.e. power dissipated by an ideal inductor in ac circuit is zero.

OR

Self Inductance of a long air-cored solenoid:

Consider a long air solenoid having 'n' number of turns per unit length. If current in solenoid is I, then magnetic field within the solenoid, $B = \mu_0 nI$... (1)

where $\mu_0 = 4 \times 10^{-7}$ henry/metre is the permeability of free space.

If A is cross-sectional area of solenoid, then effective flux linked with solenoid of length 'l' where $N = nl$ is the number of turns in length 'l' of solenoid.

$$\phi = (nl) BA$$

Substituting the value of B from (1)

$$\phi = \mu_0 nI (nl) A = \mu_0 n^2 AI l \quad \dots (2)$$

Self-inductance of air solenoid

$$L = \frac{\phi}{I} = \mu_0 n^2 AI l \quad \dots (3)$$

If N is total number of turns in length l, then

$$n = \frac{N}{l}$$

$$\text{Self-inductance } L = \mu_0 \left(\frac{N}{l}\right)^2 AI l$$

$$= \frac{\mu_0 N^2 A}{l} \quad \dots (4)$$



19. The reciprocal of resistivity (ρ) of a material is called its conductivity (σ), i.e.,

$$\sigma = \frac{1}{\rho}$$

S.I. unit of conductivity is mho m⁻¹ (or siemen m⁻¹).

(i) **Conductivity of a metallic conductor** $\sigma = \frac{1}{m} \frac{ne^2}{m}$.

With rise of temperature, the collision of electrons with fixed lattice ions/atoms increases so that relaxation time (τ) decreases. Consequently, the conductivity of metals decreases with rise of temperature. Figure represents the variation of conductivity of metal with temperature. Initially the variation of conductivity with temperature is linear and then it is non-linear.

(ii) **Conductivity of ionic conductor increases with increase of temperature** because with increase of temperature, the ionic bonds break releasing positive and negative ions which are charge carriers in ionic conductors.

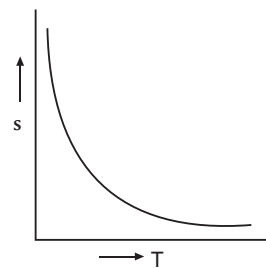

24. Wavefront: A wavefront is a locus of particles of medium all vibrating in the same phase.

Law of Reflection: Let XY be a reflecting surface at which a wavefront is being incident obliquely. Let v be the speed of the wavefront and at time $t = 0$, the wavefront touches the surface XY at A . After time t , the point B of wavefront reaches the point B' of the surface.

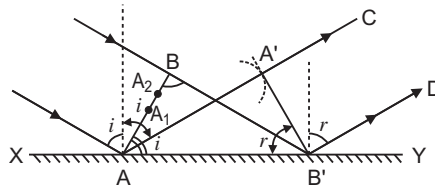

According to Huygen’s principle each point of wavefront acts as a source of secondary waves. When the point A of wavefront strikes the reflecting surface, then due to presence of reflecting surface, it cannot advance further; but the secondary wavelet originating from point A begins to spread in all directions in the first medium with speed v . As the wavefront AB advances further, its points $A_1, A_2, A_3 \dots$ etc. strike the reflecting surface successively and send spherical secondary wavelets in the first medium.

First of all the secondary wavelet starts from point A and traverses distance AA' (vt) in first medium in time t . In the same time t , the point B of wavefront, after travelling a distance BB' , reaches point B' (of the surface), from where the secondary wavelet now starts. Now taking A as centre we draw a spherical arc of radius AA' (vt) and draw tangent $A'B'$ on this arc from point B' . As the incident wavefront AB advances, the secondary wavelets starting from points between A and B , one after the other and will touch $A'B'$ simultaneously. According to Huygen’s principle wavefront $A'B'$ represents the new position of AB , i.e., $A'B'$ is the reflected wavefront corresponding to incident wavefront AB .

Now in right-angled triangles ABB' and $AA'B'$

$$\begin{array}{lll} \angle ABB' & \angle AA'B' & \text{(both are equal to } 90^\circ) \\ \text{side } BB' & \text{side } AA' & \text{(both are equal to } vt) \end{array}$$

and side AB' is common

i.e., both triangles are congruent.

$$\angle BAB' = \angle A'B'A$$

i.e., incident wavefront AB and reflected wavefront $A'B'$ make equal angles with the reflecting surface XY . As the rays are always normal to the wavefront, therefore the incident and the reflected rays make equal angles with the normal drawn on the surface XY , i.e.,

$$\text{angle of incidence } i = \text{angle of reflection } r$$

25. (i) Suppose initially the plane of coil is perpendicular to the magnetic field B . When coil rotates with angular speed ω , then after time t , the angle between magnetic field B and normal to plane of coil is

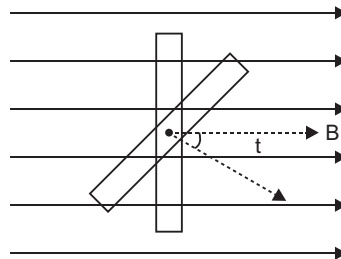

$\theta = \omega t$
At this instant magnetic flux linked with the coil
 $\Phi = BA \cos \theta$

If coil consists, N -turns, then emf induced in the coil

$$\begin{aligned} \mathcal{E} &= N \frac{d\Phi}{dt} = N \frac{d}{dt}(BA \cos \theta) \\ &= NBA \sin \theta \dots(1) \end{aligned}$$

For maximum value of emf ,

$$\sin \omega t = 1$$

Maximum emf induced, $\epsilon_{\max} = NBA$

(ii) If R is resistance of coil, the current induced, $I = \frac{\epsilon}{R}$

Instantaneous power dissipated, $P = I^2 R = \frac{\epsilon^2}{R}$... (2)

$$= \frac{N^2 B^2 A^2 \omega^2 \sin^2 \omega t}{R} \quad \text{[using (1)]} \quad \dots (3)$$

Average power dissipated in a complete cycle is obtained by taking average value of $\sin^2 \omega t$ over a complete cycle which is $\frac{1}{2}$

i.e., $(\sin^2 \omega t)_{av} = \frac{1}{2}$

Average power dissipated $P_{av} = \frac{N^2 B^2 A^2 \omega^2}{2R}$

CBSE (Delhi) SET-III

1. Cadmium is the absorbing material for neutrons produced in a nuclear reactor.
2. Coherent sources are defined as the sources in the which initial phase difference remains constant. In the case of two independent sources, the initial phase difference cannot remain constant because light is emitted due to millions of atoms and their number goes on changing in a quite random manner.

5. de Broglie wavelength, $\lambda = \frac{h}{\sqrt{2mE_k}}$

Given

$$\frac{h}{\sqrt{2m_e E_e}} = \frac{h}{\sqrt{2m_p E_p}}$$

$$\frac{E_e}{E_p} = \frac{m_p}{m_e} = 1840$$

i.e., K.E. of electron = 1840 (K.E. of proton)

7. Power of a lens increases if red light is replaced by violet light because $P = \frac{1}{f} (n_g - 1) \left(\frac{1}{R_1} - \frac{1}{R_2} \right)$, and refractive index is maximum for violet light in visible region of spectrum.

9.

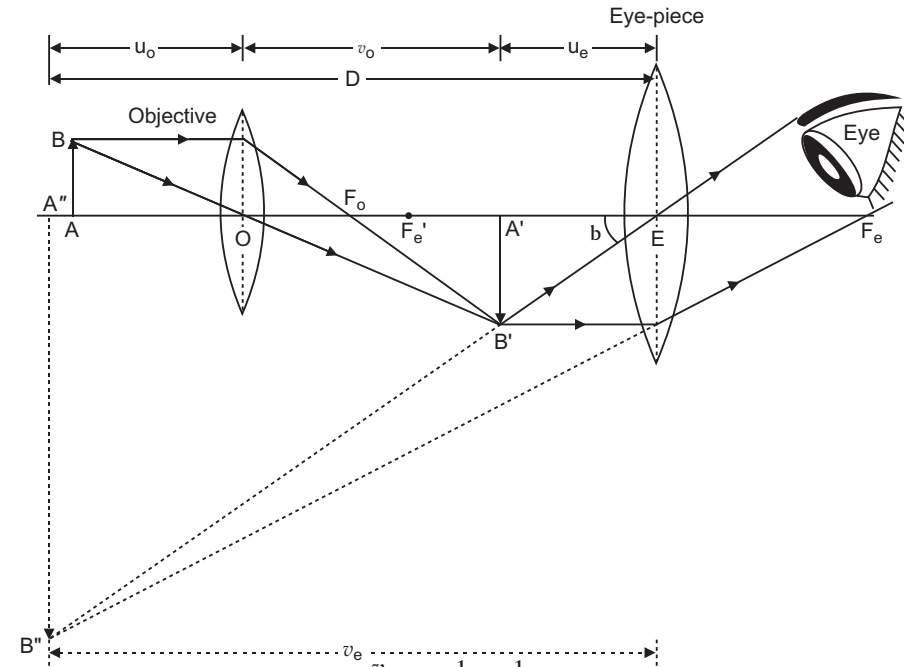

Magnifying power $M = \frac{v_o}{u_o} D \frac{1}{f_e} \frac{1}{v_e}$

or $M = \frac{v_o}{u_o} \frac{D}{f_e} \frac{D}{v_e}$

12. First gate is NOR gate, its output $C = \overline{A B}$

Second gate is also NOR gate, its output

$$Y = \overline{\overline{C} \overline{C} \overline{C} \overline{C} \overline{C} \overline{\overline{A B}} A B}$$

This is Boolean expression for OR gate.

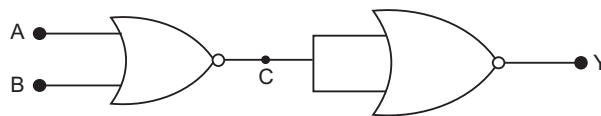

Its truth table is

A	B	Y
0	0	0
1	0	1
0	1	1
1	1	1

15. (a) Given equation is

$$E_y = 30 \sin(2 \times 10^{11} t - 300 x) \text{ Vm}^{-1}$$

Comparing with standard equation

$$E_y = E_0 \sin(\omega t - kx) \text{ Vm}^{-1}, \text{ we get}$$

$$E_0 = 30 \text{ Vm}^{-1}, \quad \omega = 2 \times 10^{11} \text{ rad s}^{-1}, k = \frac{2}{300} \text{ m}^{-1}$$

$$\text{Wavelength, } \frac{2}{300} \text{ m}$$

$$\frac{1}{150} \text{ m} = 6.67 \times 10^{-3} \text{ m}$$

- (b) The wave is propagating along X -axis, electric field is oscillating along Y -axis, so according to right hand system of (\mathbf{E} , \mathbf{B} , \mathbf{K}) the magnetic field must oscillate along Z -axis.

$$B_0 = \frac{E_0}{c} = \frac{30}{3 \times 10^8} = 10^{-7} \text{ T.}$$

Equation of oscillating magnetic field is

$$B_z = B_0 \sin(\omega t - kx) \text{ T}$$

$$B_z = 10^{-7} \sin(2 \times 10^{11} t - 300 x) \text{ T}$$

16. The magnetic field produced by current carrying larger coil C_1 in

the vicinity of small coil C_2 is $B_1 = \frac{\mu_0 I_1}{2R}$

The magnetic flux linked with shorter coil C_2 is

$$\Phi_2 = B_1 A_2 = \frac{\mu_0 I_1}{2R} r^2$$

Mutual Inductance $M = \frac{\Phi_2}{I_1} = \frac{\mu_0 r^2}{2R}$ henry.

$$20. \quad E = \frac{hc}{\lambda} = \frac{6.6 \times 10^{-34} \times 3 \times 10^8}{482 \times 10^{-9}} \text{ J}$$

$$= \frac{6.6 \times 10^{-34} \times 3 \times 10^8}{482 \times 10^{-9} \times 1.6 \times 10^{-19}} \text{ eV}$$

$$= \frac{66 \times 3000}{1027 \times 16}$$

$$= 2.57 \text{ eV}$$

$$\text{Now, } E = |3.4 - (0.85)|$$

$$= 2.55 \text{ eV}$$

Hence, transition shown by arrow B corresponds to emission of 482 nm .

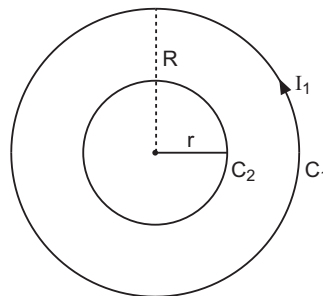

24. For power factor unity, $X_L = X_C$ $L = \frac{1}{C}$

$$L = \frac{1}{2C} = \frac{1}{(2f)^2 C} = \frac{1}{4 f^2 C}$$

Given $f = 50 \text{ Hz}$, $C = 100 \text{ F} = 100 \times 10^{-6} \text{ F} = 10^{-4} \text{ F}$

$$L = \frac{1}{4 (3.14)^2 (50)^2 \times 10^{-4}} \text{ H} = 0.1 \text{ H}$$

Current amplitude, $I_0 = \frac{V_0}{Z}$

At resonance,

$$Z = R$$

$$I_0 = \frac{V_0}{R} = \frac{200\sqrt{2}}{10} = 20\sqrt{2} \text{ A}$$

$$= 28.3 \text{ A}$$

25. Relation between electric current and drift velocity:

Consider a uniform metallic wire XY of length l and cross-sectional area A . A potential difference V is applied across the ends X and Y of the wire. This causes an electric field at each point of the wire of strength

$$E = \frac{V}{l} \quad \dots(1)$$

Due to this electric field, the electrons gain a drift velocity v_d opposite to direction of electric field. If q be the charge passing through the cross-section of wire in t seconds, then

Current in wire $I = \frac{q}{t} \quad \dots(2)$

The distance traversed by each electron in time t

$$= \text{average velocity} \times \text{time} = v_d t$$

If we consider two planes P and Q at a distance $v_d t$ in a conductor, then the total charge flowing in time t will be equal to the total charge on the electrons present within the cylinder PQ .

The volume of this cylinder = cross sectional area \times height

$$A v_d t$$

If n is the number of free electrons in the wire per unit volume, then the number of free electrons in the cylinder $n(A v_d t)$

If charge on each electron is $e (e = 1.6 \times 10^{-19} \text{ C})$, then the total charge flowing through a cross-section of the wire

$$q = (n A v_d t) (e) = n e A v_d t \quad \dots(3)$$

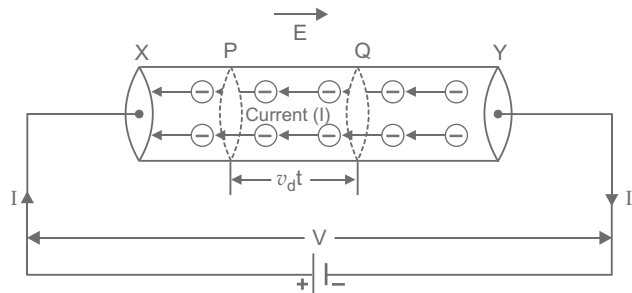

Current flowing in the wire,

$$I = \frac{q}{t} = \frac{neAv_d t}{t}$$

i.e., $I = neAv_d$... (4)

This is the relation between electric current and drift velocity. Negative sign shows that the direction of current is opposite to the drift velocity.

Numerically $I = neAv_d$... (5)

Current density, $J = \frac{I}{A} = nev_d$

$J = v_d$.

OR

We know that, $R = \frac{l}{A}$

If $l = 1, A = 1$ $R = \rho$

Thus, resistivity of a material is numerically equal to the resistance of the conductor having unit length and unit cross-sectional area.

The resistivity of a material is found to be dependent on the temperature. Different materials do not exhibit the same dependence on temperatures. Over a limited range of temperatures, that is not too large, the resistivity of a metallic conductor is approximately given by,

$$\rho_T = \rho_0 [1 + \alpha(T - T_0)]$$
 ... (1)

where ρ_T is the resistivity at a temperature T and ρ_0 is the same at a reference temperature T_0 . α is called the *temperature co-efficient of resistivity*.

The relation of Eq. (1) implies that a graph of ρ_T plotted against T would be a straight line. At temperatures much lower than 0°C , the graph, however, deviates considerably from a straight line (Figure).

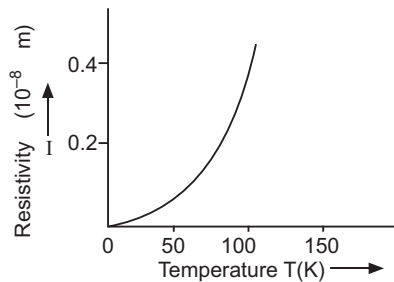

Resistivity ρ_T of copper as a function of temperature T

- 26.** Consider a metallic rod OA of length l , which is rotating with angular velocity ω in a uniform magnetic field B , the plane of rotation being perpendicular to the magnetic field. A rod may be supposed to be formed of a large number of small elements. Consider a small element of length dx at a distance x from centre. If v is the linear velocity of this element, then area swept by the element per second $= v dx$

36 Xam idea Physics—XII

The emf induced across the ends of element

$$d\mathcal{E} = B \frac{dA}{dt} = B v dx$$

But $v = x$

$$d\mathcal{E} = B x dx$$

The emf induced across the rod

$$\begin{aligned} \int_0^l B x dx &= B \int_0^l x dx \\ &= B \left[\frac{x^2}{2} \right]_0^l \\ &= B \left[\frac{l^2}{2} - 0 \right] = \frac{1}{2} B l^2 \end{aligned}$$

Current induced in rod $I = \frac{\mathcal{E}}{R} = \frac{1}{2} \frac{B l^2}{R}$

If circuit is closed, power dissipated,

$$\frac{\mathcal{E}^2}{R} = \frac{B^2 l^4}{4R}$$

CBSE EXAMINATION PAPERS

ALL INDIA-2008

Time allowed : 3 hours

Maximum marks : 70

General Instructions:

- All questions are compulsory.
- There are 30 questions in total. Questions 1 to 8 carry one mark each, questions 9 to 18 carry two marks each, questions 19 to 27 carry three marks each and questions 28 to 30 carry five marks each.
- There is no overall choice. However, an internal choice has been provided in one question of two marks, one question of three marks and all three questions of five marks each. You have to attempt only one of the given choices in such questions.
- Use of calculators is not permitted.
- You may use the following values of physical constants wherever necessary:

$$c = 3 \times 10^8 \text{ ms}^{-1}$$

$$h = 6.626 \times 10^{-34} \text{ Js}$$

$$e = 1.602 \times 10^{-19} \text{ C}$$

$$I_0 = 4 \times 10^{-7} \text{ TmA}^{-1}$$

$$\frac{1}{4\epsilon_0} = 9 \times 10^9 \text{ Nm}^2\text{C}^{-2}$$

$$\text{Boltzmann's constant } k = 1.381 \times 10^{-23} \text{ JK}^{-1}$$

$$\text{Avogadro's number } N_A = 6.022 \times 10^{23} / \text{mole}$$

$$\text{Mass of neutron } m_n = 1.675 \times 10^{-27} \text{ kg}$$

$$\text{Mass of electron } m_e = 9.1 \times 10^{-31} \text{ kg}$$

$$\text{Radius of earth} = 6400 \text{ km}$$

CBSE (All India) SET-I

- Identify the part of the electromagnetic spectrum to which the following wavelengths belong:
(i) 10^{-1} m (ii) 10^{-12} m
- How does the width of the depletion layer of a p - n junction diode change with decrease in reverse bias ?
- What is the nuclear radius of ^{125}Fe , if that of ^{27}Al is 3.6 fermi?
- When current in a coil changes with time, how is the back emf induced in the coil related to it?
- An object is held at the principal focus of a concave lens of focal length f . Where is the image formed?
- What is the geometrical shape of the wavefront when a plane wave passes through a convex lens?
- How does the stopping potential applied to a photocell change, if the distance between the light source and the cathode of the cell is doubled?
- Draw an equipotential surface for a system, consisting of two charges Q , $-Q$ separated by a distance ' r ' in air.

9. Define the term : magnetic dipole moment of a current loop. Write the expression for the magnetic moment when an electron revolves at a speed ' v ', around an orbit of radius ' r ' in hydrogen atom.
10. How will the angular separation and visibility of fringes in Young's double slit experiment change when (i) screen is moved away from the plane of the slits, and (ii) width of the source slit is increased?
11. A jet plane is travelling west at 450 ms^{-1} . If the horizontal component of earth's magnetic field at that place is 4×10^{-4} tesla and the angle of dip is 30° , find the emf induced between the ends of wings having a span of 30 m.
12. What is meant by the transverse nature of electromagnetic waves ? Draw a diagram showing the propagation of an electromagnetic wave along the x -direction, indicating clearly the directions of the oscillating electric and magnetic fields associated with it.
13. Why do we need carrier waves of very high frequency in the modulation of signals ? A carrier wave of peak voltage 20 V is used to transmit a message signal. What should be the peak voltage of the modulating signal, in order to have a modulation index of 80%?
14. Obtain the expression for the potential energy of an electric dipole of dipole moment \mathbf{p} placed in an electric field \mathbf{E} .
15. The following graph shows the variation of terminal potential difference V , across a combination of three cells in series to a resistor, versus the current, i :

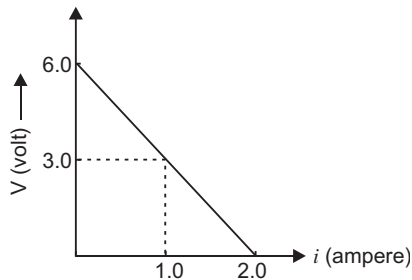

- (i) Calculate the emf of each cell.
- (ii) For what current i will the power dissipation of the circuit be maximum ?
16. State the law of radioactive decay. If N_0 is the number of radioactive nuclei in the sample at some initial time, t_0 , find out the relation to determine the number N present at a subsequent time. Draw a plot of N as a function of time.

OR

Draw a plot of the binding energy per nucleon as a function of mass number for a large number of nuclei.

Explain the energy release in the process of nuclear fission from the above plot. Write a typical nuclear reaction in which a large amount of energy is released in the process of nuclear fission.

17. In the figure given below, light rays of blue, green, red wavelengths are incident on an isosceles right-angled prism. Explain with reason, which ray of light will be transmitted through the face AC. The refractive index of the prism for red, green, blue light are 1.39, 1.424, 1.476 respectively.

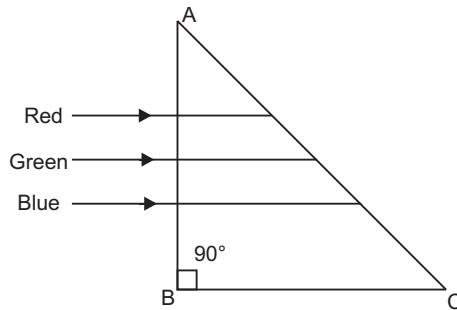

18. Two wires X, Y have the same resistivity, but their cross-sectional areas are in the ratio $2 : 3$ and lengths in the ratio $1 : 2$. They are first connected in series and then in parallel to a d.c. source. Find out the ratio of the drift speeds of the electrons in the two wires for the two cases.
19. What are permanent magnets ? What is an efficient way of preparing a permanent magnet ? Write two characteristic properties of materials which are required to select them for permanent magnets.
20. Distinguish between isotopes and isobars. Give one example for each of the species. A radioactive isotope has a half-life of 5 years. How long will it take the activity to reduce to 3 125%?
21. Two signals A, B as given below, are applied as input to (i) AND (ii) NOR and (iii) NAND gates. Draw the output wave-form in each case.

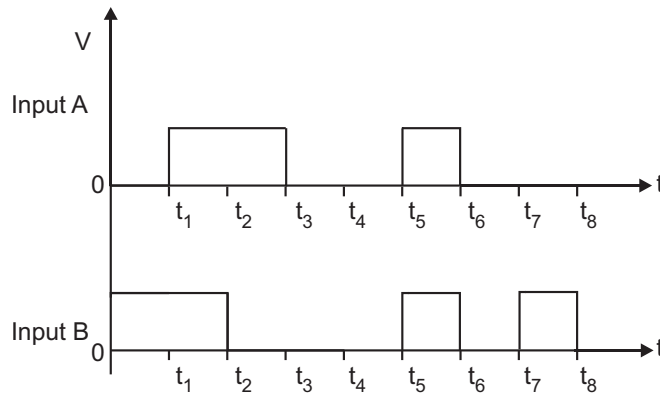

22. What does the term 'LOS communication' mean ? Name the types of waves that are used for this communication. Give typical examples, with the help of a suitable figure, of communication systems that use space wave mode propagation.
23. A resistance R is connected to one of the gaps in a metre bridge, which uses a wire of length 1 m. An unknown resistance X is connected in the other gap as shown in the figure. The balance point is noticed at ' l ' from the positive end of the battery. On interchanging R and X , it is found that the balance point further shifts by 20 cm (away from end A). Neglecting the end correction, calculate the value of unknown resistance X used.

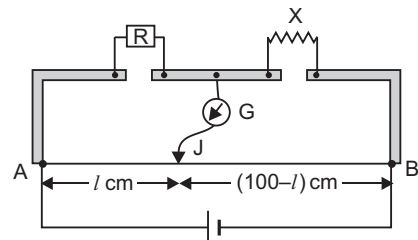

24. With a circuit diagram, explain how a zener diode can be used as a voltage regulator.

OR

Draw a circuit diagram of a full-wave rectifier. Explain its working principle. Draw the input/output wave-forms indicating clearly the functions of the two diodes used.

25. Draw a plot showing the variation of power of a lens, with the wavelength of the incident light.

A converging lens of refractive index 1.5 and of focal length 15 cm in air, has the same radii of curvature for both sides. If it is immersed in a liquid of refractive index 1.7, find the focal length of the lens in the liquid.

26. If a particle of charge q is moving with velocity v along the y -axis and the magnetic field B is acting along the z -axis, use the expression $\mathbf{F} = q(\mathbf{v} \times \mathbf{B})$ to find the direction of the force F acting on it.

A beam of proton passes undeflected with a horizontal velocity v , through a region of electric and magnetic fields, mutually perpendicular to each other and perpendicular to the direction of the beam. If the magnitudes of the electric and magnetic fields are 100 kV/m, 50 mT respectively, calculate

(i) velocity of the beam v .

(ii) force exerted by the beam on a target on the screen, if the proton beam carries a current of 0.80 mA.

27. Show that Bohr's second postulate, 'the electron revolves around the nucleus only in certain fixed orbits without radiating energy' can be explained on the basis of de-Broglie hypothesis of wave nature of electron.

28. State the condition for resonance to occur in a series LCR a.c. circuit and derive an expression for the resonant frequency.

Draw a plot showing the variation of the peak current (i_m) with frequency of the a.c. source used. Define the quality factor, Q of the circuit.

Calculate the (i) impedance, (ii) wattless current of the given a.c. circuit.

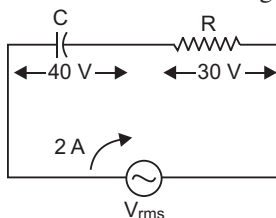

OR

Draw a labelled circuit arrangement showing the windings of primary and secondary coil in a transformer. Explain the underlying principle and working of a step-up transformer. Write any two major sources of energy loss in this device.

How much current is drawn by the primary coil of a transformer which steps down 220 V to 22 V to operate device with an impedance of 220 ohm ?

29. (a) Derive an expression for the energy stored in a parallel plate capacitor C , charged to a potential difference V .

(b) Obtain the equivalent capacitance of the network given below. For a supply of 300 V, determine the charge and voltage across C_4 .

18. Derive an expression for the torque acting on an electric dipole, which is held in a uniform electric field, when the axis of the dipole makes an angle with the electric field.

19. Draw a plot showing the variation of power of a lens with the wavelength of the incident light.

A diverging lens of refractive index 1.5 and of focal length 20 cm in air has the same radii of curvature for both sides. If it is immersed in a liquid of refractive index 1.7, calculate the focal length of the lens in the liquid.

20. If a particle of charge q is moving with velocity v along the z -axis and the magnetic field B is acting along the x -axis, use the expression $\mathbf{F} = q(\mathbf{v} \times \mathbf{B})$ to find the direction of the force F acting on it.

A beam of proton passes undeflected with a horizontal velocity v , through a region of electric and magnetic fields, mutually perpendicular to each other and normal to the direction of the beam. If the magnitudes of the electric and magnetic fields are 50 kV/m and 50 mT respectively, calculate

(i) velocity v of the beam.

(ii) force with which it strikes a target on a screen, if the proton beam current is equal to 0.80 mA.

26. A resistance $R = 5 \Omega$ is connected to one of the gaps in a metre bridge, which uses a wire of length 1 m. An unknown resistance $X = 5 \Omega$ is connected in the other gap as shown in the figure. The balance point is noticed at ' l ' cm from the positive end of the battery. On interchanging R and X , it was found that the balance point further shifts by 20 cm away from end A. Neglecting the end correction, calculate the value of unknown resistance X used.

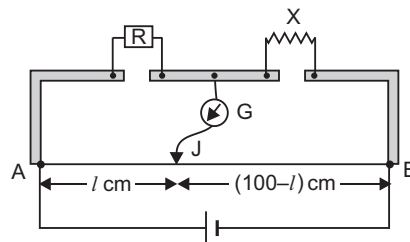

27. Draw a labelled circuit diagram of a full-wave rectifier and briefly explain its working principle.

OR

Draw a labelled circuit diagram of a transistor amplifier in the common-emitter configuration. Briefly explain, how the input/output signals differ in phase by 180° .

CBSE (All India) SET-III

Questions different from Set-I & Set-II

- A diverging lens of focal length ' F ' is cut into two identical parts each forming a plano-concave lens. What is the focal length of each part?
- What is the stopping potential applied to a photocell, if the maximum kinetic energy of electrons emitted is 5 eV?
- Draw an equipotential surface for a uniform electric field.
- State the factor, which controls :
 - wavelength of light, and
 - intensity of light emitted by an LED.

11. Using Gauss's law derive an expression for the electric field intensity at any point near a uniformly charged thin wire of charge/length λ C/m.
17. In a single slit diffraction experiment, the width of the slit is made double the original width. How does this affect the size and intensity of the central diffraction band? Draw a plot of the intensity distribution.
22. A resistance R is connected to one of the gaps in a metre bridge, which uses a wire of length 1 m. An unknown resistance X is connected in the other gap as shown in the figure. The balance point is noticed at ' l ' from the positive end of the battery. On interchanging R and X , it is found that the balance point further shifts by 20 cm (away from end A). Neglecting the end correction, calculate the value of unknown resistance X used.
24. If a particle of charge q is moving with velocity v along the x -axis and the magnetic field B is acting along the y -axis, use the expression $F = q(v \times B)$ to find the direction of the force F acting on it.
- A beam of proton passes undeflected with a horizontal velocity v , through a region of electric and magnetic fields, mutually perpendicular to each other and normal to the direction of the beam. If the magnitudes of the electric and magnetic fields are 50 kV/m, 100 mT respectively, calculate
- velocity v of the beam.
 - force with which it strikes a target on the screen, if the proton beam current is equal to 0.80 mA.
26. Distinguish between paramagnetic and diamagnetic substances. A magnetising field of 1500 A/m produces a flux of 2.4×10^{-5} weber in a bar of iron of cross-sectional area 0.5 cm^2 . Calculate the permeability and susceptibility of the iron-bar used.

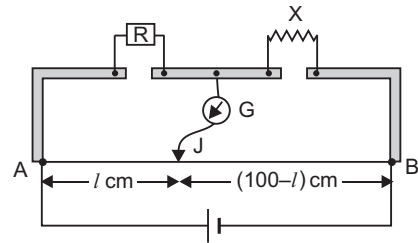

Solutions

CBSE (All India) SET-I

- $10^{-1} \text{ m} = 10 \text{ cm}$ belongs to **short radiowaves**.
 - $10^{-12} \text{ m} = 0.01 \text{ \AA}$ belongs to **gamma rays**.
- If the reverse bias across a p - n junction is decreased, the depletion region of p - n junction decreases.
- Nuclear radius, $R = R_0 A^{1/3}$ $R = A^{1/3}$
 For Al, $A = 27$, $R_{Al} = 3.6 \text{ fermi}$, for Fe $A = 125$

$$\frac{R_{Fe}}{R_{Al}} = \frac{A_{Fe}^{1/3}}{A_{Al}^{1/3}} = \frac{125^{1/3}}{27}$$

$$R_{Fe} = \frac{5}{3} R_{Al} = \frac{5}{3} \times 3.6 \text{ fermi} = 6.0 \text{ fermi}$$

4. The back emf induced in the coil **opposes** the change in current.

5.
$$\frac{1}{f} = \frac{1}{v} - \frac{1}{u}$$

Here, $u = f$ and for a concave lens $f = -f$

$$\frac{1}{v} = \frac{1}{f} - \frac{1}{f} \Rightarrow v = \frac{f}{2}$$

That is image will be formed between optical centre and focus of lens; towards the side of the object.

6. The wavefront is spherical of decreasing radius.

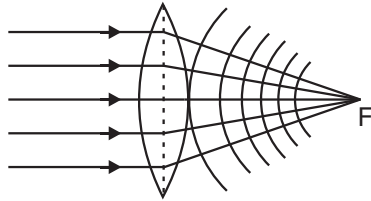

7. Stopping potential remains unchanged.

Reason: On doubling the distance between the light source and the cathode of the cell, the intensity of light incident on the photocell becomes one-fourth. As stopping potential does not depend on intensity, the stopping potential remains unchanged.

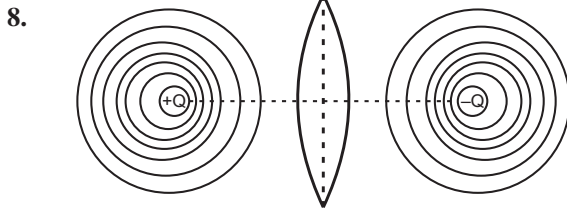

9. Magnetic moment of a current loop: The torque on current loop is $MB \sin \theta$, where θ is angle between magnetic moment and magnetic field.

$$M = \frac{\tau}{B \sin \theta}$$

If $B = 1\text{ T}$, $\sin \theta = 1$ or 90° then $M = \tau$.

That is ***the magnetic moment of a current loop is defined as the torque acting on the loop when placed in a magnetic field of 1 T such that the loop is oriented with its plane normal to the magnetic field.***

Also, $M = NIA$

i.e., magnetic moment of a current loop is the product of number of turns, current flowing in the loop and area of loop. Its direction is perpendicular to the plane of the loop.

Magnetic moment of Revolving Electron,

$$M = \frac{e v r}{2}$$

10. (i) Angular separation $\frac{\Delta \theta}{D} = \frac{\Delta \theta}{d}$

It is independent of D ; therefore, angular separation remains unchanged if screen is moved away from the slits. But the actual separation between fringes $\frac{\Delta x}{D}$ increases, so **visibility of fringes increases.**

- (ii) When width of source slit is increased, then the angular fringe width remains unchanged but fringes become less and less sharp; so visibility of fringes decreases. If the condition $\frac{\Delta \theta}{S} = \frac{\Delta \theta}{d}$ is not satisfied, the interference pattern disappears.

11. The wings of jet plane will cut the vertical component of earth's magnetic field, so emf is induced across the wing. The vertical component of earth's magnetic field.

$$V = H \tan \theta$$

Given $H = 4.0 \times 10^{-4} \text{ T}, \theta = 30^\circ$

$$V = (4.0 \times 10^{-4} \text{ T}) \tan 30^\circ$$

$$= 4.0 \times 10^{-4} \times \frac{1}{\sqrt{3}} = \frac{4}{\sqrt{3}} \times 10^{-4} \text{ T}$$

Induced emf across the wing

$$V = vl$$

Given $v = 450 \text{ ms}^{-1}, l = 30 \text{ m}$

$$V = \frac{4}{\sqrt{3}} \times 10^{-4} \times (450) \times 30 \text{ V} = 3.12 \text{ V}$$

12. Transverse Nature of Electromagnetic Waves:

In an electromagnetic wave, the electric and magnetic field vectors oscillate, perpendicular to the direction of propagation of wave. This is called transverse nature of electromagnetic wave.

In an electromagnetic wave, the three vectors **E**, **B** and **K** form a right handed system. Accordingly if a wave is propagating along X-axis, the electric field vector oscillates along Y-axis and magnetic field vector oscillates along Z-axis. Diagram is shown in fig.

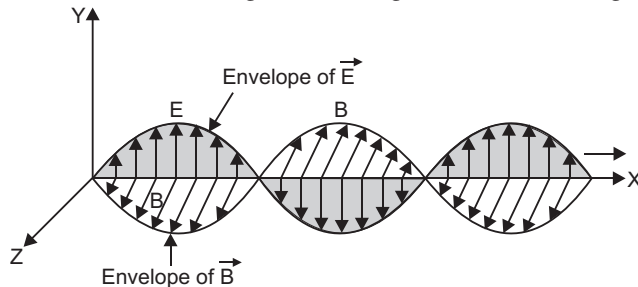

13. High frequency waves require antenna of reasonable length and can travel long distances without any appreciable power loss; so we need high frequency carrier waves.

If E_m is the peak value of modulating signal and E_C that of carrier wave.

Modulation index, $m_a = \frac{E_m}{E_c}$

Given $m_a = 80\%$, $E_c = 20 \text{ V}$
 $E_m = m_a E_c = 0.80 \times 20 \text{ V} = 16 \text{ V}$

14. The potential energy of an electric dipole of an electric field is defined as the work done in bringing the dipole from infinity to its present position in the electric field.

Suppose the dipole is brought from infinity and placed at orientation with the direction of electric field. The work done in this process may be supposed to be done in two parts.

- (i) The work done (W_1) in bringing the dipole perpendicular to electric field from infinity.
- (ii) Work done (W_2) in rotating the dipole such that it finally makes an angle from the direction of electric field.

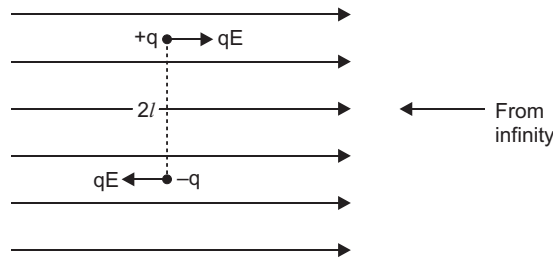

(i) Let us suppose that the electric dipole is brought from infinity in the region of a uniform electric field such that its dipole moment \mathbf{p} always remains perpendicular to electric field. The electric forces on charges $+q$ and $-q$ are qE and qE , along the field direction and opposite to field direction respectively. As charges $+q$ and $-q$ traverse equal distance under equal and opposite forces; therefore, net work done in bringing the dipole in the region of electric field perpendicular to field-direction will be zero, i.e., $W_1 = 0$.

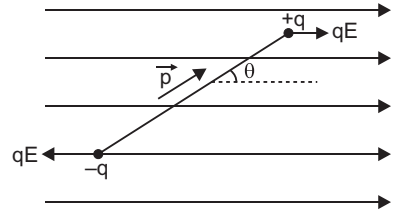

(ii) Now the dipole is rotated and brought to orientation making an angle with the field direction (i.e., $\theta_1 = 90^\circ$ and $\theta_2 = \theta$), therefore, work done

$$W_2 = pE(\cos \theta_1 - \cos \theta_2)$$

$$= pE(\cos 90^\circ - \cos \theta) = pE \cos \theta$$

Total work done in bringing the electric dipole from infinity, i.e., Electric potential energy of electric dipole.

$$U = W_1 + W_2 = 0 + pE \cos \theta = pE \cos \theta$$

In vector form $U = \mathbf{p} \cdot \mathbf{E}$

15. (i) Let \mathcal{E} be emf and r the internal resistance of each cell.
 The equation of terminal potential difference

$$V_{\text{eff}} = \mathcal{E} - i r_{\text{int}} \text{ becomes}$$

$$V = 3\mathcal{E} - i r_{\text{int}} \quad \dots(1)$$

where r_{int} is effective (total) internal resistance.

From fig., when $i = 0, V = 6.0 \text{ V}$

From (1),

$$6 - 3i = 0$$

$$\frac{6}{3} = 2 \text{ V}$$

i.e., emf of each cell, $= 2 \text{ V}$

- (ii) For maximum power dissipation, the effective internal resistance of cells must be equal to external resistance.

From fig., when $V = 0, i = 2.0 \text{ A}$.

Equation (1) gives

$$0 = 6 - 3(2) - 2i(r_{\text{int}})$$

$$r_{\text{int}} = \frac{3}{2} = \frac{3}{2} = 1.5 \text{ } \Omega$$

For maximum power, external resistance,

$$R = r_{\text{int}} = 1.5 \text{ } \Omega$$

Current in circuit, $i = \frac{E}{R + r_{\text{int}}} = \frac{6}{1.5 + 1.5} = 2.0 \text{ A}$

Thus, emf of each cell, $= 2 \text{ V}$

and for maximum power dissipation, current in circuit $= 2.0 \text{ A}$

- 16. Radioactive decay Law:** The rate of decay of radioactive nuclei is directly proportional to the number of undecayed nuclei at that time.

i.e., $\frac{dN}{dt} = -\lambda N$

or $\frac{dN}{N} = -\lambda dt$

where λ is the decay constant.

Suppose initially the number of atoms in radioactive element is N_0 and N the number of atoms after time t . According to Rutherford and Soddy law

$$\frac{dN}{N} = -\lambda dt \quad \text{where } \lambda \text{ is disintegration constant}$$

$$\int_{N_0}^N \frac{dN}{N} = -\lambda \int_0^t dt$$

Integrating $\log_e N = -\lambda t + C$... (1)

where C is a constant of integration.

If N_0 is initial number of radioactive nuclei, then at $t = 0, N = N_0$; so

$$\log_e N_0 = 0 + C \quad C = \log_e N_0$$

Substituting this equation in (1), we get

$$\log_e N = \log_e N_0 - \lambda t$$

$$\log_e \frac{N}{N_0} = -\lambda t$$

$$\frac{N}{N_0} = e^{-\lambda t} = N_0 e^{-\lambda t}$$

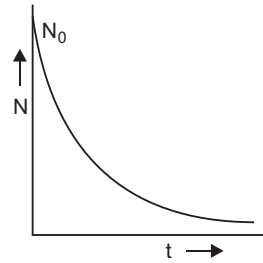

The graph is shown in figure.

OR

The variation of binding energy per nucleon versus mass number is shown in figure.

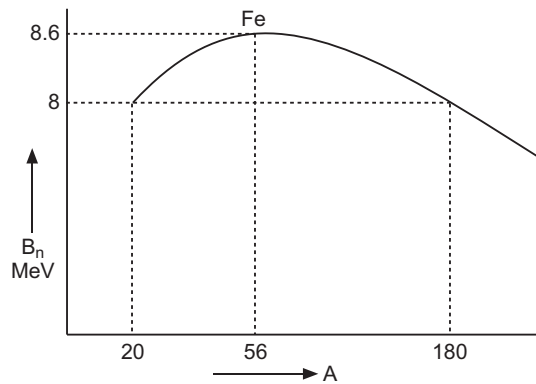

The binding energy curve indicates that binding energy for nucleon of heavy nuclei is less than that of middle nuclei. Clearly a heavy nucleus breaks into two lighter nuclei then binding energy per nucleon will increase and energy will be released in the process. This process is called nuclear fission.

Nuclear fission reaction is

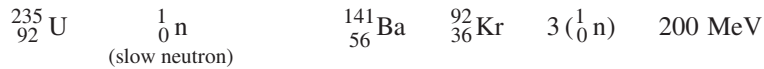

17. The critical angle for green light C_g is

$$\sin C_g = \frac{1}{n_g} = \frac{1}{1.424} = 0.7022$$

$$C_g = \sin^{-1}(0.7022) = 44.6^\circ$$

The critical angle for red light

$$\sin C_r = \frac{1}{n_r} = \frac{1}{1.39}$$

$$C_r = \sin^{-1}(0.7194) = 46^\circ$$

The critical angle for blue light

$$\sin C_b = \frac{1}{n_b} = \frac{1}{1.476} = 0.6775$$

$$C_b = \sin^{-1}(0.6775) = 42.6^\circ$$

As angle of incidence at face AC is 45° ,

which is smaller than critical angle for red ray but greater than critical angles, for green and blue rays, therefore, red-ray will be transmitted through the face AC.

18. (i) When wires are connected in series :

In series, the current remains the same; so we use the relation $i = neAv_d$.

$$\text{Resistivity, } \frac{m}{ne^2} \qquad n = \frac{m}{e^2}$$

$$i = \frac{m}{e^2} eAv_d \qquad \text{or} \qquad i = \frac{m}{e} Av_d$$

$$v_d = \frac{ie}{mA}$$

For same temperature $\frac{ie}{mA}$ is same; $v_d \propto \frac{1}{A}$

$$\frac{(v_d)_X}{(v_d)_Y} = \frac{A_Y}{A_X} = \frac{3}{2}$$

(ii) **When wires are connected in parallel :** In parallel, the potential difference is the same. In this case we apply the formula for drift velocity.

$$v_d = \frac{e}{m} E \qquad v_d = \frac{e}{m} \frac{V}{l}$$

For same temperature $\frac{e}{m} \frac{V}{l}$ is the same, so $v_d \propto \frac{1}{l}$

$$\frac{(v_d)_X}{(v_d)_Y} = \frac{l_Y}{l_X} = \frac{2}{1}$$

19. **Permanent Magnets:** The magnets prepared from ferromagnetic materials which retain their magnetic properties for a long time are called permanent magnets.

An efficient way to make a permanent magnet is to place a ferromagnetic rod in a solenoid and pass a current. The magnetic field of the solenoid magnetises the rod.

The materials used for permanent magnet must have the following characteristic properties :

- (i) High retentivity so that the magnet may cause strong magnetic field.
- (ii) High coercivity so that the magnetisation is not wiped out by strong external fields, mechanical ill-treatment and temperature changes. The loss due to hysteresis is immaterial because the magnet in this case is never put to cyclic changes.

20.

Isotopes	Isobars
The nuclides having the same atomic number Z but different atomic masses (A) are called isotopes. Examples : ${}^1_1\text{H}$, ${}^2_1\text{H}$, ${}^3_1\text{H}$	The nuclides having the same atomic mass (A) but different atomic numbers (Z) are called isobars. Examples : ${}^3_1\text{H}$, ${}^3_2\text{He}$

We know $\frac{R}{R_0} = \frac{1}{2}^n$

50 Xam idea Physics—XII

Given $\frac{R}{R_0} = 3.125\% = \frac{3.125}{100}$

$\frac{3.125}{100} = \left(\frac{1}{2}\right)^n$ or $\frac{1}{32} = \left(\frac{1}{2}\right)^n$

or $\frac{1}{2}^5 = \frac{1}{2}^n$

Given $T = 5$ years

As $n = \frac{t}{T}$

$\frac{t}{5} = 5$ or $t = 5 \times 5 = 25$ years

21.

Time interval	Inputs		AND	NOR	NAND
	A	B	$Y = A \cdot B$	$Y = \overline{A + B}$	$Y = \overline{A \cdot B}$
0 to t_1	0	1	0	0	1
t_1 to t_2	1	1	1	0	0
t_2 to t_3	1	0	0	0	1
t_3 to t_4	0	0	0	1	1
t_4 to t_5	0	0	0	1	1
t_5 to t_6	1	1	1	0	0
t_6 to t_7	0	0	0	1	1
t_7 to t_8	0	1	0	0	1

Output waveforms of the three gates:

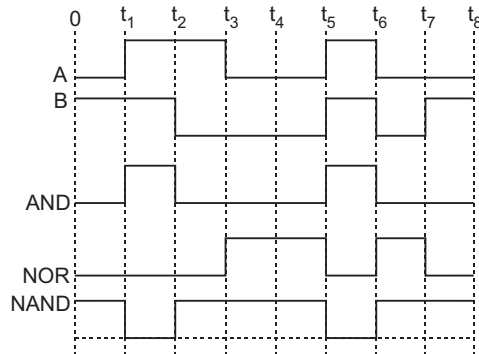

22. **LOS Communication:** It means “Line of sight communication”.
Space waves are used for LOS communication.

In this communication the space waves (radio or microwaves) travel directly from transmitting antenna to receiving antenna.

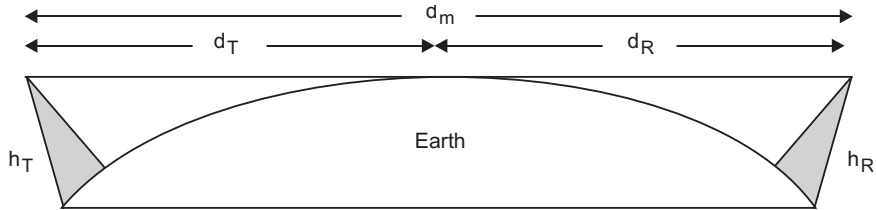

Communication System using Space wave mode propagation are (i) LOS communication and Fig. shows LOS communication system.

If transmitting antenna and receiving antenna have heights h_T and h_R respectively, then Radio horizon of transmitting antenna,

$$d_T = \sqrt{2R_e h_T}$$

where R_e is radius of earth and radio horizon of receiving antenna.

$$d_R = \sqrt{2R_e h_R}$$

Maximum line of sight distance, $d_M = d_T + d_R = \sqrt{2R_e h_T} + \sqrt{2R_e h_R}$

(ii) Television, broadcast, microwave links and satellite communication

The satellite communication is shown in fig. The space wave used is microwave.

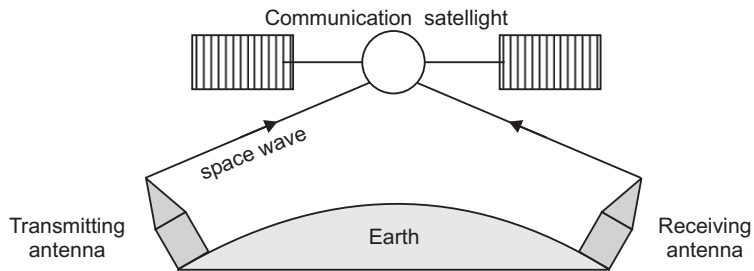

23. From 'metre bridge' formula

$$\frac{R}{X} = \frac{l}{100 - l}$$

$$X = \frac{100 - l}{l} R$$

Given $R = 2$ $X = \frac{(100 - l)}{l} \cdot 2$... (1)

On interchanging R and X , the balance point is obtained at a distance $(l - 20)$ cm from end A , so

$$\frac{X}{R} = \frac{l - 20}{100 - (l - 20)} \quad X = \frac{l - 20}{80 - l} R \quad \dots (2)$$

Equating (1) and (2)

$$\frac{(100 - l)}{l} = 2 \quad \frac{l - 20}{80 - l} = 2$$

Solving we get $l = 40$ cm

Unknown resistance, $X = \frac{100 - l}{l} = 2$

$$X = \frac{100 - 40}{40} = 2$$

$$X = 3$$

24. Zener diode as a Voltage Regulator

The Zener diode makes its use as a voltage regulator due to the following property:

When a Zener diode is operated in the breakdown region, the voltage across it remains practically constant for a large change in the current.

A simple circuit of a voltage regulator using a Zener diode is shown in the Fig. The Zener diode is connected across load such that it is reverse biased.

The series resistance R absorbs the output voltage fluctuations so as to maintain constant voltage across the load.

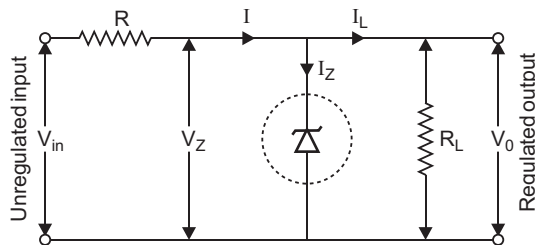

If the input dc voltage increases, the current through R and Zener diode also increases. So, voltage drop across R increases, without any change in the voltage across zener diode.

I-V Characteristics

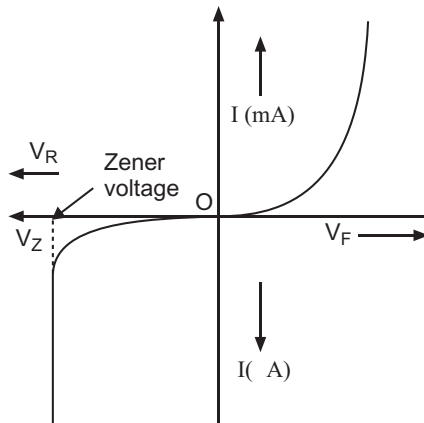

OR

Full Wave Rectifier : For full wave rectifier we use two junction diodes. The circuit diagram for full wave rectifier using two junction diodes is shown in figure.

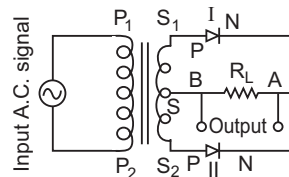

Suppose during first half cycle of input ac signal the terminal S_1 is positive relative to S and S_2 is negative relative to S , then diode I is forward biased and diode II is reverse biased. Therefore current flows in diode I and not in diode II. The direction of current i_1 due to diode I in load resistance R_L is directed from A to B. In next half cycle, the terminal S_1 is negative relative to S and S_2 is positive relative to S . Then diode I is reverse biased and diode II is forward biased. Therefore current flows in diode II and there is no current in diode I. The direction of current i_2 due to diode II in load resistance is again from A to B. Thus for input a.c. signal the output current is a continuous series of unidirectional pulses. This output current may be converted in fairly steady current by the use of suitable filters.

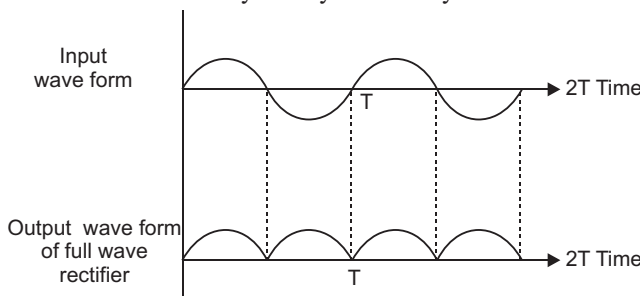

25. Refractive index $n = \frac{B}{A}$, where λ is the wavelength.

Power of a lens $P = \frac{1}{f} = (n_g - 1) \left(\frac{1}{R_1} - \frac{1}{R_2} \right)$

Clearly, power of a lens $\propto \frac{1}{\lambda}$. This implies that the power of a lens decreases with increase of wavelength $P \propto \frac{1}{\lambda}$ nearly. The plot is shown in figure.

Given $f_a = 15$ cm, $n_g = 1.5$, $n_l = 1.7$

Focal length of lens in liquid,

$$f_l = \frac{n_g - 1}{n_l - 1} f_a = \frac{1.5 - 1}{1.7 - 1} \times 15 \text{ cm} = \frac{0.5}{0.7} \times 15 \text{ cm} = 10.71 \text{ cm} \approx 10.7 \text{ cm}$$

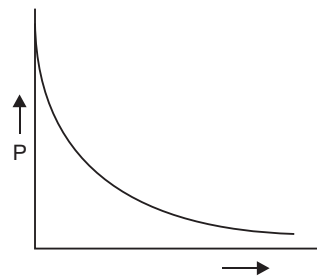

26. $\mathbf{F} = q \mathbf{v} \times \mathbf{B}$

Given $\mathbf{v} = v \hat{i}$, $\mathbf{B} = B \hat{j}$

$\mathbf{F} = q(v \hat{i}) \times (B \hat{j}) = qvB \hat{k}$

54 Xam idea Physics—XII

That is, force is acting along Z-axis.

- (i) For a beam of charged particles to pass undeflected crossed electric and magnetic fields, the condition is that electric and magnetic forces on the beam must be equal and opposite *i.e.*,

$$eE = evB$$

$$v = \frac{E}{B}$$

Given, $E = 100 \text{ kV/m} = 100 \times 10^3 \text{ V/m}$, $B = 50 \text{ mT} = 50 \times 10^{-3} \text{ T}$

$$v = \frac{100 \times 10^3}{50 \times 10^{-3}} = 2 \times 10^6 \text{ ms}^{-1}$$

- (ii) The beam strikes the target with a constant velocity, so force exerted on the target is **zero**.

However, if proton beam comes to rest, it exerts a force on the target, equal to rate of change of linear momentum of the beam *i.e.*,

$$F = \frac{p}{t} = \frac{mv}{t} = \frac{mv}{ql} = \frac{mvi}{q} = \frac{mvi}{ne}$$

where n is the number of protons striking the target per second.

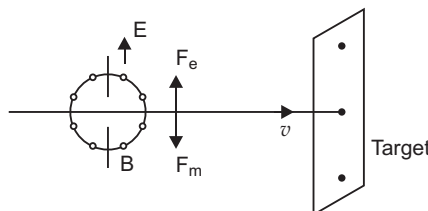

27. The de Broglie wavelength $\lambda = \frac{h}{mv}$... (1)

Now for electron in orbit

$$2\pi r = n\lambda \quad (\text{for } n\text{th orbit})$$

Using (1), we get

$$2\pi r = n \frac{h}{mv}$$

$$mvr = \frac{nh}{2}$$

This is Bohr's second postulate. As complete the Broglie wavelength may be in certain fixed orbits; so non-radiating electron can be only in certain fixed orbits.

28. Condition for resonance to occur in series **LCR ac circuit**:

For resonance the current produced in the circuit and emf applied must always be in the same phase.

Phase difference (ϕ) in series **LCR** circuit is given by

$$\tan \phi = \frac{X_C - X_L}{R}$$

For resonance

$$\phi = 0 \quad X_C = X_L = 0$$

or

$$X_C = X_L$$

If f_r is resonant frequency, then $X_C = \frac{1}{rC}$

and

$$X_L = rL$$

$$\frac{1}{rC} = rL$$

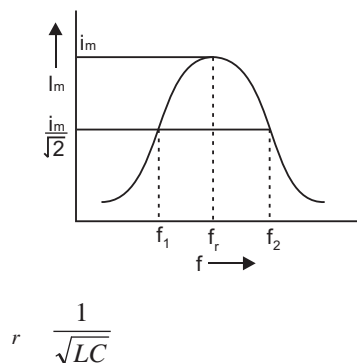

$$r = \frac{1}{\sqrt{LC}}$$

Linear resonant frequency, $f_r = \frac{1}{2\pi\sqrt{LC}}$

The graph of variation of peak current i_m with frequency is shown in fig.

Half power frequencies are the frequencies on either side of resonant frequency for which current reduces to half of its maximum value. In fig. f_1 and f_2 are half power frequencies.

Quality Factor (Q): The quality factor is defined as the ratio of resonant frequency to the width of half power frequencies.

i.e., $Q = \frac{f_r}{f_2 - f_1} = \frac{rL}{R}$

(i) Potential difference across capacitance, $V_C = X_C I$

Capacitive reactance, $X_C = \frac{V_C}{I} = \frac{40}{2} = 20$

Resistance, $R = \frac{V_R}{I} = \frac{30}{2} = 15$

Impedance, $Z = \sqrt{R^2 + X_C^2} = \sqrt{(15)^2 + (20)^2} = \sqrt{225 + 400} = \sqrt{625} = 25$

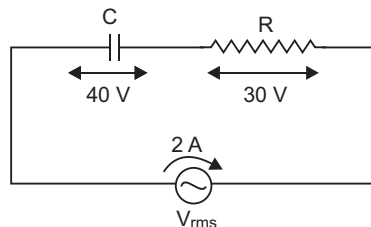

(ii) The phase lead (ϕ) of current over applied voltage is

$\tan \phi = \frac{X_C}{R}$

Wattless Current, $I_{wattless} = I \sin \phi = I \cdot \frac{X_C}{Z} = 2 \cdot \frac{20}{25} = 1.6 \text{ A}$

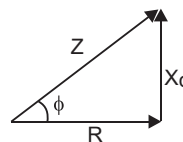

OR

Arrangements of winding of primary and secondary coil in a transformer are shown in fig. (a) and (b).

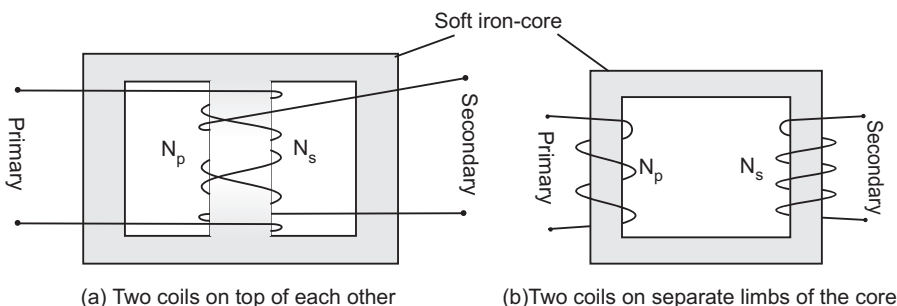

Transformer: Transformer is a device by which an alternating voltage may be decreased or increased. This is based on the principle of mutual-induction.

Step up Transformer: It transforms the alternating low voltage to alternating high voltage and in this the number of turns in secondary coil is more than that in primary coil. (i.e., $N_S > N_P$).

Working: When alternating current source is connected to the ends of primary coil, the current changes continuously in the primary coil; due to which the magnetic flux linked with the secondary coil changes continuously, therefore the alternating emf of same frequency is developed across the secondary.

Let N_p be the number of turns in primary coil, N_S the number of turns in secondary coil and ϕ the magnetic flux linked with each turn. **We assume that there is no leakage of flux so that the flux linked with each turn of primary coil and secondary coil is the same.** According to Faraday's laws the emf induced in the primary coil

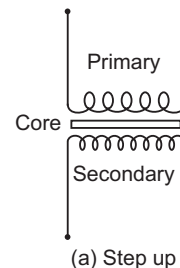
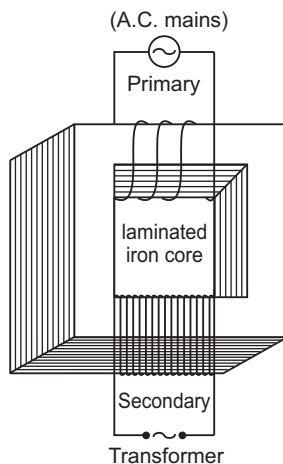

$$\mathcal{E}_p = -N_p \frac{d\phi}{dt} \quad \dots(1)$$

and emf induced in the secondary coil

$$\mathcal{E}_s = -N_S \frac{d\phi}{dt} \quad \dots(2)$$

From (1) and (2)

$$\frac{\mathcal{E}_s}{\mathcal{E}_p} = \frac{N_S}{N_P} \quad \dots(3)$$

If the resistance of primary coil is negligible, the emf (\mathcal{E}_p) induced in the primary coil, will be equal to the applied potential difference (V_p) across its ends. Similarly if the secondary circuit is open, then the potential difference V_S across its ends will be equal to the emf (\mathcal{E}_s) induced in it; therefore

$$\frac{V_S}{V_p} = \frac{\mathcal{E}_s}{\mathcal{E}_p} = \frac{N_S}{N_P} = r \text{ (say)} \quad \dots(4)$$

where $r = \frac{N_S}{N_P}$ is called the *transformation ratio*. If i_p and i_s are the instantaneous currents in

primary and secondary coils and there is no loss of energy; then

Power in primary = Power in secondary

$$V_p i_p = V_S i_S$$

$$\frac{i_S}{i_p} = \frac{V_p}{V_S} = \frac{N_P}{N_S} = \frac{1}{r} \quad \dots(5)$$

In step up transformer, $N_s > N_p$ $r > 1$;

So $V_s > V_p$ and $i_s < i_p$

i.e. step up transformer increases the voltage but decreases the current.

Reasons for energy losses in a transformer

- (i) **Joule Heating:** Energy is lost in resistance of primary and secondary windings as heat (I^2Rt).
- (ii) **Flux Leakage:** Energy is lost due to coupling of primary and secondary coils not being perfect, i.e., whole of magnetic flux generated in primary coil is not linked with the secondary coil.

Current in secondary coil, $I_s = \frac{V_s}{Z} = \frac{220}{220} \text{ A} = 1 \text{ A}$

For an ideal transformer

$$\text{Current in primary coil, } I_p = \frac{V_p I_p}{V_s I_s} = \frac{220 \times 0.1}{220} = 0.01 \text{ A}$$

29. (a) When a capacitor is charged by a battery, work is done by the charging battery at the expense of its chemical energy. This work is stored in the capacitor in the form of electrostatic potential energy.

Consider a capacitor of capacitance C . Initial charge on capacitor is zero. Initial potential difference between capacitor plates is zero. Let a charge Q be given to it in small steps. When charge is given to capacitor, the potential difference between its plates increases. Let at any instant when charge on capacitor be q , the potential difference

between its plates $V = \frac{q}{C}$

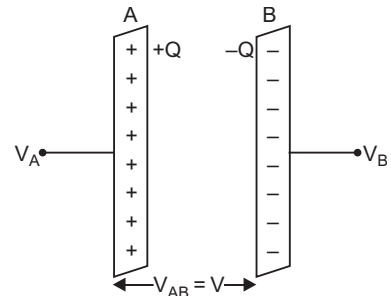

Now work done in giving an additional infinitesimal charge dq to capacitor

$$dW = V dq = \frac{q}{C} dq$$

The total work done in giving charge from 0 to Q will be equal to the sum of all such infinitesimal works, which may be obtained by integration. Therefore total work

$$W = \int_0^Q V dq = \int_0^Q \frac{q}{C} dq = \frac{1}{C} \left[\frac{q^2}{2} \right]_0^Q = \frac{1}{2C} \frac{Q^2}{2} = \frac{Q^2}{2C}$$

If V is the final potential difference between capacitor plates, then $Q = CV$

$$W = \frac{(CV)^2}{2C} = \frac{1}{2} CV^2 = \frac{1}{2} QV$$

This work is stored as electrostatic potential energy of capacitor *i.e.*,

$$\text{Electrostatic potential energy, } U = \frac{Q^2}{2C} = \frac{1}{2} CV^2 = \frac{1}{2} QV$$

(b)

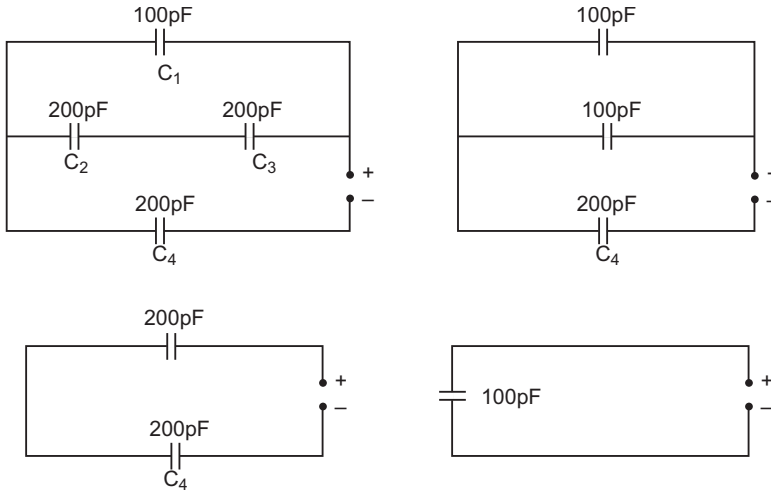

$$\text{Now, } Q = C_{eq} V = 100 \times 10^{-12} \times 300 = 3 \times 10^{-8} \text{ coulomb}$$

$$\text{Potential difference across } C_4 = \frac{Q}{C_4} = \frac{3 \times 10^{-8}}{200 \times 10^{-12}} = 1.5 \times 10^2 \text{ } \mathbf{150 \text{ V}}$$

OR

This is a machine that can build up high voltages of the order of a few million volts.

Principle: It is based on the following two electrostatic phenomena:

- (i) The charge always resides on the outer surface of a hollow conductor.
- (ii) The electric discharge in air or a gas takes place readily at the pointed ends of the conductors.

Construction. It consists of a large hollow metallic sphere *S* mounted on two insulating columns *A* and *B* and an endless belt of rubber or silk is made to run on two pulleys *P*₁ and *P*₂ by the means of an electric motor. *C*₁ and *C*₂ are two sharp metallic spikes in the form of combs. The lower comb *C*₁ is connected to the positive terminal of a very high voltage source (HTS) (10^4 volts.) and the upper comb *C*₂ is connected to the inner surface of metallic sphere *S*.

Working: When comb C_1 is given very high potential, then it produces ions in its vicinity, due to action of sharp points. The positive ions, so produced, get sprayed on the belt due to the repulsion between positive ions and comb C_1 . These positive ions are carried upward by the moving belt. The pointed end of C_2 just touches the belt. The comb C_2 collects positive charge from the belt which immediately moves to the outer surface of sphere S . As the belt goes on revolving, it continues to take () charge upward, which is collected by comb C_2 and transferred to outer surface of sphere S . Thus the outer surface of metallic sphere S gains positive charge continuously and its potential rises to a very high value.

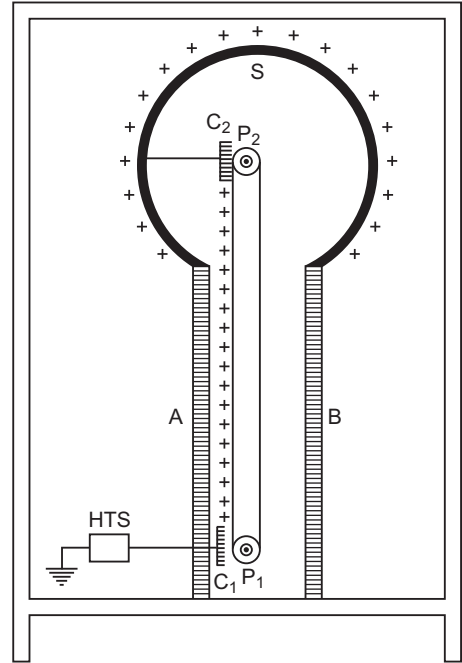

When the potential of a metallic sphere gains very high value, the dielectric strength of surrounding air breaks down and its charge begins to leak, to the surrounding air. The maximum potential is reached when the rate of leakage of charge becomes equal to the rate of charge transferred to the sphere. To prevent leakage of charge from the sphere, the generator is completely enclosed in an earthed connected steel tank which is filled with air under high pressure.

Van de Graaff generator is used to accelerate stream of charged particles to very high velocities. Such a generator is installed at IIT Kanpur which accelerates charged particles upto 2 MeV energy. Due to a charged shell (radius R), the maximum electric field is at the surface of the shell. If maximum charge is Q , then

$$E_{\max} = \frac{1}{4\pi\epsilon_0} \frac{Q}{R_{\min}^2} \quad \dots(1)$$

Also the potential
$$V = \frac{1}{4\pi\epsilon_0} \frac{Q}{R_{\min}} \quad \dots(2)$$

From (1) and (2)
$$\frac{V}{E_{\max}} = R_{\min}$$

Here $V = 15 \times 10^6 \text{ V}$, $E_{\max} = 5 \times 10^7 \text{ Vm}^{-1}$

$$R_{\min} = \frac{V}{E_{\max}} = \frac{15 \times 10^6}{5 \times 10^7} = 3 \times 10^{-1} \text{ m} = 30 \text{ cm.}$$

30.

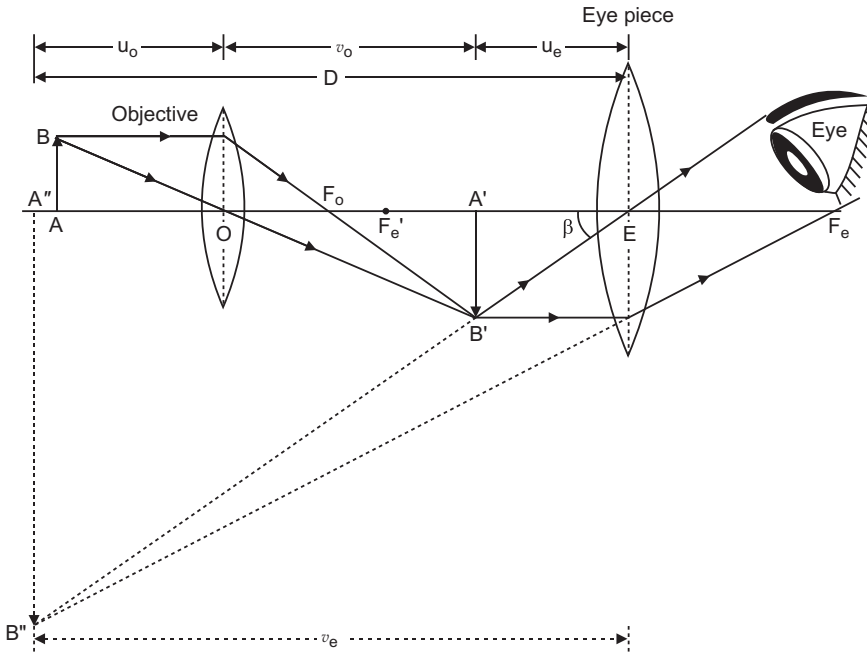

Magnifying power of compound microscope is

$$M = \frac{v_o}{u_o} \approx 1 + \frac{D}{f_o} \quad \text{for final image at distance of distinct vision}$$

$$\frac{L}{f_o} \approx 1 + \frac{D}{f_e}$$

$$M = \frac{v_o}{u_o} \frac{D}{f_e} = \frac{L}{f_o} \frac{D}{f_e} \quad \text{for final image at infinity}$$

Given $f_o = 2.0 \text{ cm}$, $f_e = 6.25 \text{ cm}$, $L = 15 \text{ cm}$, $u_o = ?$

(i) When final image is formed at least distance of distinct vision ($D = 25 \text{ cm}$) :

For eye lens : Here $v_e = 25 \text{ cm}$

$$\frac{1}{f_e} = \frac{1}{v_e} + \frac{1}{u_e}$$

$$\frac{1}{6.25} = \frac{1}{25} + \frac{1}{u_e} \quad \Rightarrow \quad \frac{1}{u_e} = \frac{1}{6.25} - \frac{1}{25} = \frac{4}{25}$$

or $u_e = 5 \text{ cm}$

As $L = |v_o| + |u_e| \quad \Rightarrow \quad |v_o| = L - |u_e| = 15 - 5 = 10 \text{ cm}$

For objective lens:

$$\frac{1}{f_o} = \frac{1}{v_o} + \frac{1}{u_o}$$

$$\frac{1}{u_0} + \frac{1}{v_0} = \frac{1}{f_0}$$

$$\frac{1}{2.5} + \frac{1}{10} = \frac{1}{2.5}$$

That is distance of object from objective is 2.5 cm.

Magnification, $M = \frac{v_0}{u_0} = 1 \times \frac{D}{f_e} = \frac{10}{2.5} = 1 \times \frac{25}{6.25} = 4$

(ii) When final image is formed at infinity :

In this case $L = v_0 = f_e = 15.625 = 8.75$ cm

For objective lens :

$$\frac{1}{f_0} + \frac{1}{v_0} = \frac{1}{u_0}$$

$$\frac{1}{8.75} + \frac{1}{15.625} = \frac{1}{u_0}$$

$$u_0 = \frac{2.875}{6.75}$$

$u_0 = 2.59$ cm, $|u_0| = 2.59$ cm

Magnification, $M = \frac{v_0}{u_0} = \frac{D}{f_e} = \frac{8.75}{2.59} = \frac{25}{6.25} = 13.5$

OR

Magnifying power $m = \frac{f_0}{f_e}$ It does not change with increase of aperture of objective lens,

because focal length of a lens has no concern with the aperture of lens.

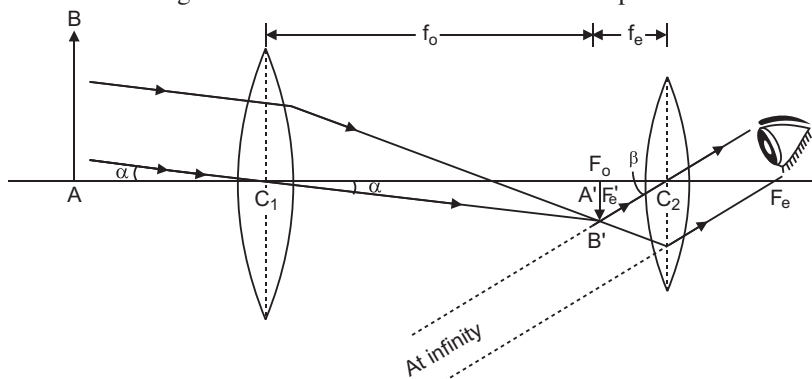

Drawbacks:

- (i) It is not free from chromatic aberration.
- (ii) The image formed is inverted and fainter.

(a) Given $f_0 = 15$ m, $f_e = 10$ cm $= 10 \times 10^{-2}$ m

Angular magnification of telescope,

$$m = \frac{f_0}{f_e} = \frac{15}{10 \times 10^{-2}} = 1500$$

Negative sign shows that the final image is inverted.
 Let D be diameter of moon, d diameter of image of moon formed by objective and r the distance of moon from objective lens, then from Fig.

$$\frac{D}{r} = \frac{d}{f_0}$$

$$d = \frac{D}{r} f_0 = \frac{3.48 \times 10^6}{3.8 \times 10^8} \times 15 \text{ m}$$

$$= 0.137 \text{ m} = 13.7 \text{ cm}$$

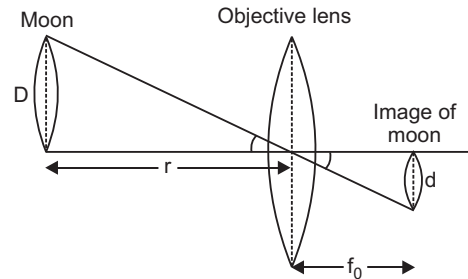

CBSE (All India) SET-II

2. $E_k = eV_0 = 6 \text{ eV}$ $eV_0 = V_0 = 6 \text{ V}$

The stopping potential $V_0 = 6 \text{ volt (negative)}$.

4. (i) wavelength 1 mm belongs to the microwaves.

(ii) wavelength $10^{-11} \text{ m} = 0.1 \text{ \AA}$ belongs to **gamma rays**.

5. The fractional change due to incident light on minority charge carriers in reverse bias is much more than that over the majority charge carriers in forward bias. So, photodiodes are used to measure the intensity in reverse bias condition.

13. Magnetic field due to a toroidal solenoid: A long solenoid shaped in the form of closed ring is called a toroidal solenoid (or endless solenoid). Let n be the number of turns per unit length of toroid and I the current flowing through it. The current causes the magnetic field inside the turns of the solenoid. The magnetic lines of force inside the toroid are in the form of concentric circles. By symmetry the magnetic field has the same magnitude at each point of circle and is along the tangent at every point on the circle.

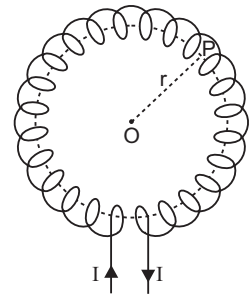

For points inside the core of toroid

Consider a circle of radius r in the region enclosed by turns of toroid. Now we apply Ampere's circuital law to this circular path, *i.e.*,

$$\oint \mathbf{B} \cdot d\mathbf{l} = \mu_0 I \quad \dots(1)$$

$$\oint \mathbf{B} \cdot d\mathbf{l} = \int B dl \cos 0 = B \cdot 2\pi r$$

Length of toroid $= 2\pi r$

Number of turns in toroid $= n(2\pi r)$

current in one-turn $= I$

Current enclosed by circular path $= (n \cdot 2\pi r) \cdot I$

Equation (1) gives

$$B = \frac{\mu_0}{4\pi} \frac{2r}{r^3} = \frac{\mu_0}{2\pi} \frac{n^2 r I}{r^3}$$

$$B = \frac{\mu_0}{2\pi} \frac{n^2 I}{r}$$

18. Consider an electric dipole placed in a uniform electric field of strength E in such a way that its dipole moment

\mathbf{p} makes an angle θ with the direction of \mathbf{E} . The charges of dipole are $+q$ and $-q$ at separation $2l$ the dipole moment of electric dipole,

$$\mathbf{p} = q \cdot 2l \quad \dots(1)$$

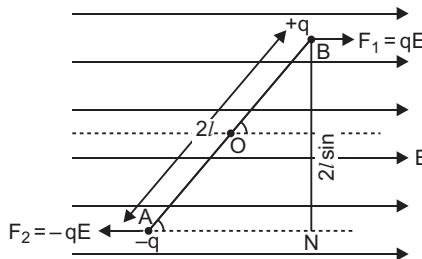

Force: The force on charge $+q$ is, $\mathbf{F}_1 = q\mathbf{E}$, along the direction of field \mathbf{E}

The force on charge $-q$ is, $\mathbf{F}_2 = -q\mathbf{E}$, opposite to the direction of field \mathbf{E}

Obviously forces \mathbf{F}_1 and \mathbf{F}_2 are equal in magnitude but opposite in direction; hence net force on electric dipole in uniform electric field is

$$\mathbf{F} = \mathbf{F}_1 + \mathbf{F}_2 = q\mathbf{E} - q\mathbf{E} = 0 \text{ (zero)}$$

As net force on electric dipole is zero, so dipole does not undergo any translatory motion.

Torque: The forces \mathbf{F}_1 and \mathbf{F}_2 form a couple (or torque) which tends to rotate and align the dipole along the direction of electric field. This couple is called the torque and is denoted by τ .

torque = magnitude of one force \times perpendicular distance between lines of action of forces

$$= qE (BN)$$

$$= qE (2l \sin \theta)$$

$$= (q \cdot 2l) E \sin \theta$$

$$= pE \sin \theta$$

[using (1)]

$$\dots(2)$$

Clearly, the magnitude of torque depends on orientation (θ) of the electric dipole relative to electric field. Torque (τ) is a vector quantity whose direction is perpendicular to both \mathbf{p} and \mathbf{E} .

In vector form

$$\boldsymbol{\tau} = \mathbf{p} \times \mathbf{E}$$

$$\dots(3)$$

Thus, if an electric dipole is placed in an electric field in oblique orientation, it experiences no force but experiences a torque. The torque tends to align the dipole moment along the direction of electric field.

Maximum Torque: For maximum torque $\sin \theta$ should be the maximum. As the maximum value of $\sin \theta$ is 1 when $\theta = 90^\circ$

$$\text{Maximum Torque, } \tau_{\max} = pE$$

19. Refractive index $n = A \frac{B}{\lambda}$, where λ is the wavelength.

$$\text{Power of a lens } P = \frac{1}{f} = (n_g - 1) \left(\frac{1}{R_1} - \frac{1}{R_2} \right)$$

Clearly, power of a lens $\propto (n_g - 1)$. This implies that the power of a lens decreases with increase of wavelength $P \propto \frac{1}{\lambda}$ nearly.

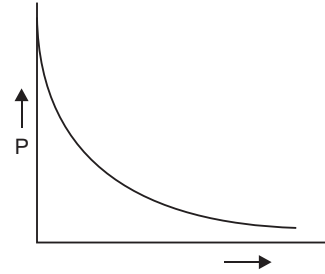

The plot is shown in fig.

Given $f_a = 20$ cm, $n_g = 1.5$, $n_l = 1.7$

Focal length of lens in liquid,

$$f_l = \frac{n_g - 1}{\frac{n_g}{n_l} - 1} f_a = \frac{1.5 - 1}{\frac{1.5}{1.7} - 1} (20) \text{ cm}$$

$$= \frac{0.5}{1.5/1.7 - 1} (20) \text{ cm} = \mathbf{85 \text{ cm}} \text{ (Converging)}$$

20. $F = qv \times B$

Given, $v = v\hat{k}$, $B = B\hat{i}$

$$F = q(v\hat{k}) \times (B\hat{i}) = qvB\hat{j}$$

That is, force is acting along y-axis.

(i) For a beam of charged particles to pass undeflected crossed electric and magnetic fields, the condition is that electric and magnetic forces on the beam must be equal and opposite *i.e.*,

$$eE = evB$$

$$v = \frac{E}{B}$$

Given, $E = 50$ kV/m $= 50 \times 10^3$ V/m, $B = 50$ mT $= 50 \times 10^{-3}$ T

$$v = \frac{50 \times 10^3}{50 \times 10^{-3}} = \mathbf{1 \times 10^6 \text{ ms}^{-1}}$$

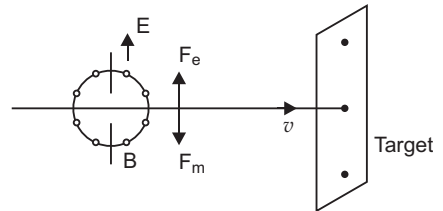

(ii) The beam strikes the target with a constant velocity, so force exerted on the target is **zero**.

However, if proton beam comes to rest, it exerts a force on the target, equal to rate of change of linear momentum of the beam *i.e.*,

$$F = \frac{p}{t} = \frac{mv}{t} = \frac{mv}{ql} \hat{i} = \frac{mvi}{ne}$$

where n is the number of protons striking the target per second.

26. From 'metre bridge' formula

$$\frac{R}{X} = \frac{l}{100 - l}$$

$$X = \frac{100 - l}{l} R$$

Given $R = 5$

$$X = \frac{(100 - l)}{l} \times 5 \quad \dots(1)$$

On interchanging R and X , the balance point is obtained at a distance $(l - 20)$ cm from end A, so

$$\frac{X}{R} = \frac{l - 20}{100 - (l - 20)}$$

$$X = \frac{l - 20}{80 - l} \times 5 \quad \dots(2)$$

Equating (1) and (2)

$$\frac{(100 - l)}{l} \times 5 = \frac{l - 20}{80 - l} \times 5$$

Solving we get $l = 40$ cm

Unknown resistance, $X = \frac{100 - l}{l} \times 5 = \frac{100 - 40}{40} \times 5$

$$X = \frac{15}{2} = 7.5$$

27. **Full Wave Rectifier:** For full wave rectifier we use two junction diodes. The circuit diagram for full wave rectifier using two junction diodes is shown in figure.

Suppose during first half cycle of input ac signal the terminal S_1 is positive relative to S and S_2 is negative relative to S , then diode I is forward biased and diode II is reverse biased. Therefore current flows in diode I and not in diode II. The direction of current i_1 due to diode I in load resistance R_L is directed from A to B. In next half cycle, the terminal S_1 is negative relative to S and S_2 is positive relative to S . Then diode I is reverse biased and diode II is forward biased. Therefore current flows in diode II and there is no current in diode I. The direction of current i_2 due to diode II in load resistance is again from A to B. Thus for input a.c. signal the output current is a continuous series of unidirectional pulses. This output current may be converted in fairly steady current by the use of suitable filters.

OR

Common-Emitter Transistor Amplifier: Common-emitter transistor amplifier gives the highest gain and hence it is the most commonly employed circuit. Fig. depicts the circuit for a $p-n-p$ transistor. In this circuit, the emitter is common to both the input (emitter-base) and output (collector-emitter) circuits and is grounded. The emitter-base circuit is forward biased and the base-collector circuit is reverse biased.

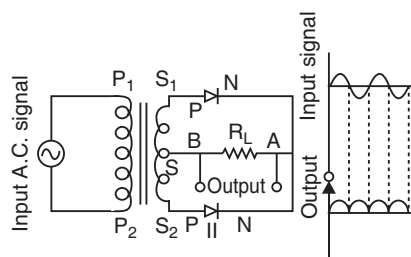

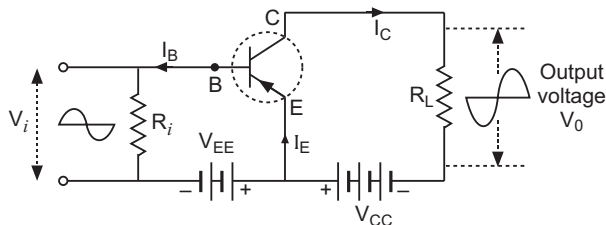

In a common-emitter circuit, the collector-current is controlled by the base-current rather than the emitter-current. Since in a transistor, a large collector-current corresponds to a very small base-current, therefore, when input signal is applied to base, a very small change in base-current provides a much larger change in collector-current and thus extremely large current gains are possible.

Referring to fig., when positive half cycle is fed to the input circuit, it opposes the forward bias of the circuit which causes the collector current to decrease. It decreases the voltage drop across load R_L and thus makes collector voltage more negative. Thus when input cycle varies through a positive half cycle, the output voltage developed at the collector varies through a negative half cycle and vice versa. Thus the output voltage in common-emitter amplifier is in antiphase with the input signal or the *output and input voltages are 180° out of phase.*

CBSE (All India) SET-III

2. For a complete diverging lens.

$$\frac{1}{F} = (n_g - 1) \left(\frac{1}{R} - \frac{1}{R} \right)$$

$$F = \frac{R}{2(n_g - 1)}$$

For each planoconcave lens

$$\frac{1}{F} = (n_g - 1) \left(\frac{1}{R} - \frac{1}{\infty} \right)$$

$$F = \frac{R}{(n_g - 1)} = 2F$$

*i.e., focal length of each half part will be **twice the** focal length of initial diverging lens.*

4. $E_k = eV_0 = 5 eV = eV_0 = V_0 = 5V$

The stopping potential $V_0 = 5 \text{ volt (negative)}$.

- 5.

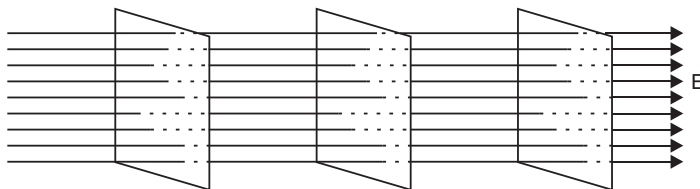

6. (i) Wavelength of light emitted depends on the nature of semiconductor.
 (ii) Intensity of light emitted depends on the **forward current**.

11. Gauss Theorem : The net outward electric flux through a closed surface is equal to $\frac{1}{\epsilon_0}$ times the net charge enclosed within the surface *i.e.*,

$$\oint_S \mathbf{E} \cdot d\mathbf{S} = \frac{1}{\epsilon_0} q$$

Electric field due to infinitely long, thin and uniformly charged straight wire:

Consider an infinitely long line charge having linear charge density λ coulomb metre⁻¹ (linear charge density means charge per unit length). To find the electric field strength at a distance r , we consider a cylindrical Gaussian surface of radius r and length l coaxial with line charge. The cylindrical Gaussian surface may be divided into three parts:

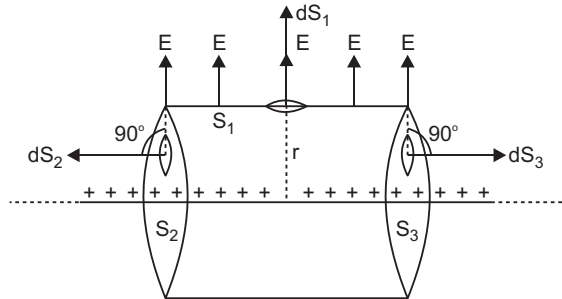

- (i) Curved surface S_1 (ii) Flat surface S_2 and (iii) Flat surface S_3 .

By symmetry the electric field has the same magnitude E at each point of curved surface S_1 and is directed radially outward.

We consider small elements of surfaces S_1, S_2 and S_3 . The surface element vector $d\mathbf{S}_1$ is directed along the direction of electric field (*i.e.*, angle between \mathbf{E} and $d\mathbf{S}_1$ is zero); the elements $d\mathbf{S}_2$ and $d\mathbf{S}_3$ are directed perpendicular to field vector \mathbf{E} (*i.e.*, angle between $d\mathbf{S}_2$ and \mathbf{E} is 90 and so also angle between $d\mathbf{S}_3$ and \mathbf{E}).

Electric Flux through the cylindrical surface

$$\oint_S \mathbf{E} \cdot d\mathbf{S} = \int_{S_1} \mathbf{E} \cdot d\mathbf{S}_1 + \int_{S_2} \mathbf{E} \cdot d\mathbf{S}_2 + \int_{S_3} \mathbf{E} \cdot d\mathbf{S}_3$$

$$= \int_{S_1} E dS_1 \cos 0 + \int_{S_2} E dS_2 \cos 90 + \int_{S_3} E dS_3 \cos 90$$

$$= \int_{S_1} E dS_1 + 0 + 0$$

$E \int_{S_1} dS_1$ (since electric field E is the same at each point of curved surface)

$E \cdot 2\pi r l$ (since area of curved surface $= 2\pi r l$)

As λ is charge per unit length and length of cylinder is l , therefore, charge enclosed by assumed surface $= (\lambda l)$

By Gauss's theorem

$$\oint_S \mathbf{E} \cdot d\mathbf{S} = \frac{1}{\epsilon_0} \text{charge enclosed}$$

$$E \propto \frac{1}{r}$$

$$E = \frac{\lambda}{2\epsilon_0 r}$$

Thus, the electric field strength due to a line charge is inversely proportional to r .

17. The angular size of central diffraction band, $2 \frac{\lambda}{a}$. When width of slit ' a ' is doubled, the size of central band becomes half and the intensity is doubled.

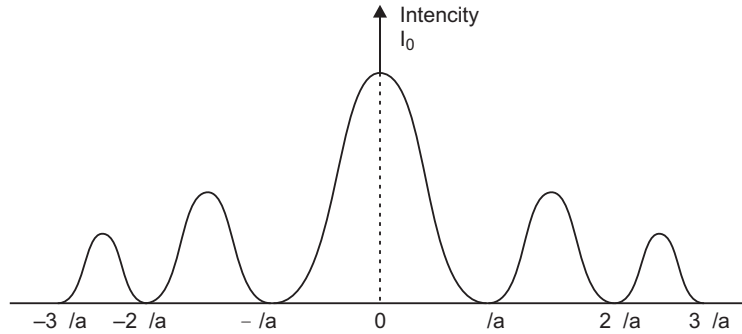

22. From 'metre bridge' formula

$$\frac{R}{X} = \frac{l}{100 - l} \quad \text{X} = \frac{100 - l}{l} R$$

Given $R = 4 \quad \text{X} = \frac{(100 - l)}{l} \cdot 4 \quad \dots(1)$

On interchanging R and X , the balance point is obtained at a distance $(l - 20)$ cm from end A, so

$$\frac{X}{R} = \frac{l - 20}{100 - (l - 20)} \quad \text{X} = \frac{l - 20}{80 - l} \cdot 4 \quad \dots(2)$$

Equating (1) and (2)

$$\frac{(100 - l)}{l} \cdot 4 = \frac{l - 20}{80 - l} \cdot 4$$

Solving we get $l = 40$ cm

Unknown resistance, $\text{X} = \frac{100 - l}{l} \cdot 4 = \frac{100 - 40}{40} \cdot 4 = 6$

24. $F = qv \times B$

Given, $v = v\hat{i}, \quad B = B\hat{j}$

$$F = q(v\hat{i}) \times (B\hat{j}) = qvB\hat{k}$$

That is, force is acting along z-axis.

- (i) For a beam of charged particles to pass undeflected crossed electric and magnetic fields, the condition is that electric and magnetic forces on the beam must be equal and opposite *i.e.*,

$$eE = evB$$

$$v = \frac{E}{B}$$

Given, $E = 50 \text{ kV/m} = 50 \times 10^3 \text{ V/m}$, $B = 100 \text{ mT} = 100 \times 10^{-3} \text{ T}$

$$v = \frac{50 \times 10^3}{100 \times 10^{-3}}$$

$$v = 5 \times 10^5 \text{ ms}^{-1}$$

- (ii) The beam strikes the target with a constant velocity, so force exerted on the target is **zero**.

However, if proton beam comes to rest, it exerts a force on the target, equal to rate of change of linear momentum of the beam *i.e.*,

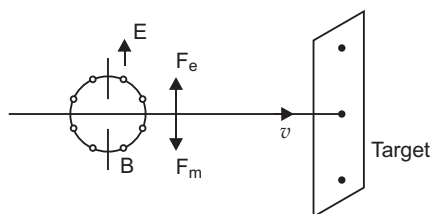

$$F = \frac{p}{t} = \frac{mv}{t} = \frac{m \cdot v}{q/i} = \frac{mvi}{q} = \frac{mvi}{ne}$$

where n is the number of protons striking the target per second.

26. Distinction between diamagnetic, paramagnetic and ferromagnetic substances

	Property	Diamagnetic	Paramagnetic
(i)	Susceptibility (χ)	1 (negative and small)	0 (positive and small)
(ii)	Permeability (μ_r)	0 μ_r 1 (less than 1)	1 μ_r 1 (slightly greater than 1)
(iii)	Coercivity	High	Low
	Example	Gold	Platinum

The magnetic field lines near a diamagnetic substance and a paramagnetic substance are shown below:

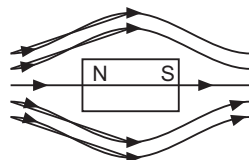

(i) Field lines near a Diamagnetic

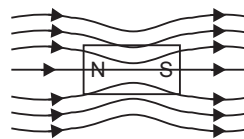

(ii) Field lines near a Paramagnetic

70 Xam idea Physics—XII

Here, $H = 1500 \text{ A/m}$, $B = 2.4 \times 10^{-5} \text{ Wb}$, $A = 0.5 \times 10^{-4} \text{ m}^2$

\therefore

$$\frac{B}{AH}$$

$$\frac{2.4 \times 10^{-5}}{0.5 \times 10^{-4} \times 1500}$$

$$= 3.2 \times 10^{-4} \text{ Wb/Am}$$

Now,

$$\mu_r = \frac{3.2 \times 10^{-4}}{4 \times 10^{-7}} = 255$$

Magnetic susceptibility,

$$\mu_r - 1 = 255 - 1 = 254$$

CBSE EXAMINATION PAPERS

DELHI-2009

Time allowed : 3 hours

Maximum marks : 70

General Instructions:

- All questions are compulsory.
- There are 30 questions in total. Questions 1 to 8 carry one mark each, questions 9 to 18 carry two marks each, questions 19 to 27 carry three marks each and questions 28 to 30 carry five marks each.
- There is no overall choice. However, an internal choice has been provided in one question of two marks, one question of three marks and all three questions of five marks each. You have to attempt only one of the given choices in such questions.
- Use of calculators is not permitted.
- You may use the following values of physical constants wherever necessary:

$$c = 3 \times 10^8 \text{ ms}^{-1}$$

$$h = 6.626 \times 10^{-34} \text{ Js}$$

$$e = 1.602 \times 10^{-19} \text{ C}$$

$$\mu_0 = 4\pi \times 10^{-7} \text{ TmA}^{-1}$$

$$\frac{1}{4\pi\epsilon_0} = 9 \times 10^9 \text{ Nm}^2\text{C}^{-2}$$

$$\text{Boltzmann's constant } k = 1.381 \times 10^{-23} \text{ J K}^{-1}$$

$$\text{Avogadro's number } N_A = 6.022 \times 10^{23} \text{ /mole}$$

$$\text{Mass of neutron } m_n = 1.2 \times 10^{-27} \text{ kg}$$

$$\text{Mass of electron } m_e = 9.1 \times 10^{-31} \text{ kg}$$

$$\text{Radius of earth} = 6400 \text{ km}$$

CBSE (Delhi) SET-I

- What is sky wave propagation? 1
- Write the following radiations in ascending order in respect of their frequencies :
X-rays, microwaves, UV-rays and radio waves 1
- Magnetic field lines can be entirely confined within the core of a toroid, but not within a straight solenoid. Why? 1
- You are given following three lenses. Which two lenses will you use as an eyepiece and as an objective to construct an astronomical telescope? 1

Lenses	Power (P)	Aperture (A)
L ₁	3 D	8 cm
L ₂	6 D	1 cm
L ₃	10 D	1 cm

5. If the angle between the pass axis of polarizer and the analyser is 45° , write the ratio of the intensities of original light and the transmitted light after passing through the analyser. **1**
6. The figure shows a plot of three curves *a*, *b*, *c* showing the variation of photocurrent vs. collector plate potential for three different intensities I_1, I_2 and I_3 having frequencies ν_1, ν_2 and ν_3 respectively incident on a photosensitive surface.
- Point out the two curves for which the incident radiations have same frequency but different intensities. **1**

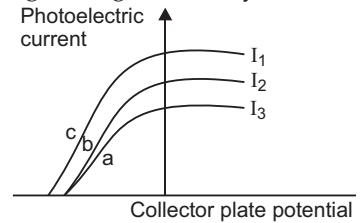

7. What type of wavefront will emerge from a (i) point source, and (ii) distant light source? **1**
8. Two nuclei have mass numbers in the ratio 1 : 2. What is the ratio of their nuclei densities? **1**
9. A cell of emf ' E ' and internal resistance ' r ' is connected across a variable resistor ' R '. Plot a graph showing the variation of terminal potential ' V ' with resistance R . Predict from the graph the condition under which ' V ' becomes equal to ' E '. **2**
10. (i) Can two equi-potential surfaces intersect each other? Give reasons. **1**
 (ii) Two charges $-q$ and $+q$ are located at points $A(0, 0, -a)$ and $B(0, 0, +a)$ respectively. How much work is done in moving a test charge from point $P(7, 0, 0)$ to $Q(-3, 0, 0)$? **2**
11. By what percentage will the transmission range of a T.V. tower be affected when the height of the tower is increased by 21 %? **2**
12. Derive an expression for drift velocity of free electrons in a conductor in terms of relaxation time. **2**
13. How does a charge q oscillating at certain frequency produce electromagnetic waves? **2**
 Sketch a schematic diagram depicting electric and magnetic fields for an electromagnetic wave propagating along the Z -direction. **2**

14. A charge ' q ' moving along the X -axis with a velocity \vec{v} is subjected to a uniform magnetic field B acting along the Z -axis as it crosses the origin O . **2**

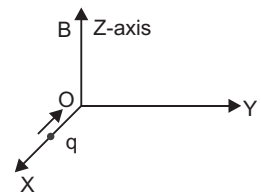

- (i) Trace its trajectory.
- (ii) Does the charge gain kinetic energy as it enters the magnetic field? Justify your answer.
15. The following figure shows the input waveforms (A, B) and the output waveform (Y) of a gate. Identify the gate, write its truth table and draw its logic symbol.

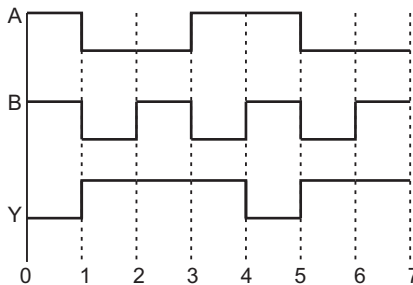

16. State Biot-Savart law.

A current I flows in a conductor placed perpendicular to the plane of the paper. Indicate the direction of the magnetic field due to a small element $d\vec{l}$ at point P situated at a distance r from the element as shown in the figure.

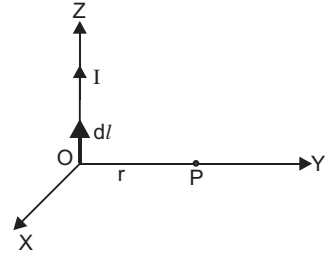

17. Why are high frequency carrier waves used for transmission?

OR

What is meant by term 'modulation'? Draw a block diagram of a simple modulator for obtaining an AM signal.

18. A radioactive nucleus 'A' undergoes a series of decays according to the following scheme :

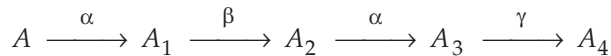

The mass number and atomic number of A are 180 and 72 respectively. What are these numbers for A_4 ?

19. A thin conducting spherical shell of radius R has charge Q spread uniformly over its surface. Using Gauss's law, derive an expression for an electric field at a point outside the shell.

Draw a graph of electric field $E(r)$ with distance r from the centre of the shell or $0 \leq r \leq \infty$.

20. Three identical capacitors C_1, C_2 and C_3 of capacitance $6 \mu\text{F}$ each are connected to a 12 V battery as shown.

Find:

- charge on each capacitor
- equivalent capacitance of the network
- energy stored in the network of capacitors

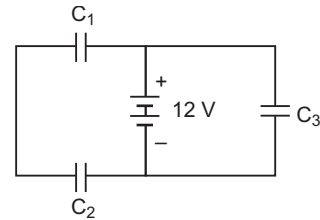

21. (a) The energy levels of an atom are as shown below. Which of them will result in the transition of a photon of wavelength 275 nm?

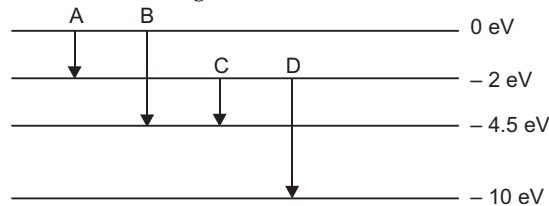

(b) Which transition corresponds to emission of radiation of maximum wavelength?

22. A proton and an alpha particle are accelerated through the same potential. Which one of the two has (i) greater value of de-Broglie wavelength associated with it, and (ii) less kinetic energy? Justify your answers.
23. In a single slit diffraction experiment, when a tiny circular obstacle is placed in the path of light from a distant source, a bright spot is seen at the centre of the shadow of the obstacle. Explain why?

State two points of difference between the interference pattern obtained in Young's double slit experiment and the diffraction pattern due to a single slit.

24. (a) Define self inductance. Write its S.I. units.
 (b) Derive an expression for self inductance of a long solenoid of length l , cross-sectional area A having N number of turns.

25. The figure shows experimental set up of a meter bridge. When the two unknown resistances X and Y are inserted, the null point D is obtained 40 cm from the end A . When a resistance of $10\ \Omega$ is connected in series with X , the null point shifts by 10 cm. Find the position of the null point when the $10\ \Omega$ resistance is instead connected in series with resistance ' Y '. Determine the values of the resistances X and Y .

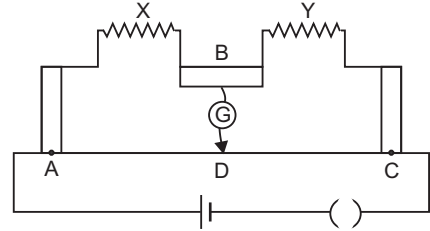

26. Derive the expression for force per unit length between two long straight parallel current carrying conductors. Hence, define one ampere.

OR

Explain the principle and working of a cyclotron with the help of a schematic diagram. Write the expression for cyclotron frequency.

27. Three light rays red (R), green (G) and blue (B) are incident on a right angled prism ' abc ' at face ' ab '. The refractive indices of the material of the prism for red, green and blue wavelengths are 1.39 , 1.44 and 1.47 respectively. Out of the three which colour ray will emerge out of face ' ac '? Justify your answer. Trace the path of these rays after passing through face ' ab '.

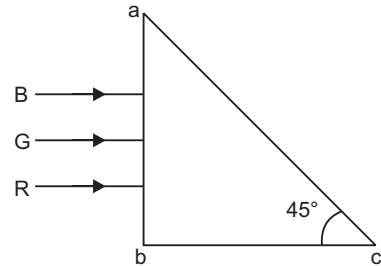

28. (a) Derive an expression for the average power consumed in a series LCR circuit connected to a.c. source in which the phase difference between the voltage and the current in the circuit is ϕ .
 (b) Define the quality factor in an a.c. circuit. Why should the quality factor have high value in receiving circuits? Name the factors on which it depends.

OR

- (a) Derive the relationship between the peak and the rms value of current in an a.c. circuit.
 (b) Describe briefly, with the help of a labelled diagram, working of a step-up transformer.

A step-up transformer converts a low voltage into high voltage. Does it not violate the principle of conservation of energy? Explain.

29. (i) Draw a circuit diagram to study the input and output characteristics of an $n-p-n$ transistor in its common emitter configuration. Draw the typical input and output characteristics.
 (ii) Explain, with the help of a circuit diagram, the working of $n-p-n$ transistor as a common emitter amplifier.

OR

How is a zener diode fabricated so as to make it a special purpose diode? Draw I - V characteristics of zener diode and explain the significance of breakdown voltage.

Explain briefly, with the help of a circuit diagram, how a p - n junction diode works as a half wave rectifier.

30. Trace the rays of light showing the formation of an image due to a point object placed on the axis of a spherical surface separating the two media of refractive indices n_1 and n_2 . Establish the relation between the distances of the object, the image and the radius of curvature from the central point of the spherical surface.

Hence, derive the expression of the lens maker's formula.

OR

Draw the labelled ray diagram for the formation of image by a compound microscope.

Derive the expression for the total magnification of a compound microscope. Explain why both the objective and the eye piece of a compound microscope must have short focal lengths.

CBSE (DELHI) SET-II

Questions different from Set-I.

1. Name the electromagnetic radiation to which waves of wavelength in the range of 10^{-2} m belong. Give one use of this part of EM spectrum. 1
2. What is ground wave propagation? 1
5. Unpolarized light is incident on a plane surface of refractive index μ at angle i . If the reflected light gets totally polarized, write the relation between the angle i and refractive index μ .
6. Draw a diagram to show refraction of a plane wavefront incident on a convex lens and hence draw the refracted wave front. 1
8. The nuclei have mass numbers in the ratio 1 : 3. What is the ratio of their nuclear densities? 1
11. The output of a 2-input AND gate is fed to a NOT gate. Give the name of the combination and its logic symbol. Write down its truth table. 2
16. A radioactive nucleus 'A' undergoes a series of decays according to the following scheme: 2

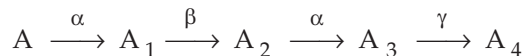

The mass number and atomic number of A_4 are 172 and 69 respectively. What are these numbers for A_4 ?

19. The equivalent capacitance of the combination between A and B in the given figure is $4 \mu\text{F}$. 3

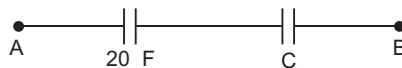

- (i) Calculate capacitance of the capacitor C.

- (ii) Calculate charge on each capacitor if a 12 V battery is connected across terminals A and B .
- (iii) What will be the potential drop across each capacitor?
20. State Gauss's law in electrostatic. Using this law derive an expression for the electric field due to a uniformly charged infinite plane sheet. 3
22. An electron and a proton are accelerated through the same potential. Which one and the two has (i) greater value of de-Broglie wavelength associated with it and (ii) less momentum? Justify your answer. 3

CBSE (DELHI) SET-III

Questions different from Set-I and Set-II.

2. At what angle of incidence should a light beam strike a glass slab of refractive index $\sqrt{3}$, such that the reflected and the refracted rays are perpendicular to each other? 1
3. What is space wave propagation? 1
5. Name the part of electromagnetic spectrum which is suitable for : 1
- (i) radar systems used in aircraft navigation
- (ii) treatment of cancer tumours.
6. Two nuclei have mass numbers in the ratio 2 : 5. What is the ratio of their nuclear densities? 1
7. Differentiate between a ray and a wavefront.
12. (i) Sketch the output waveform from an AND gate for the inputs A and B shown in the figure. 2

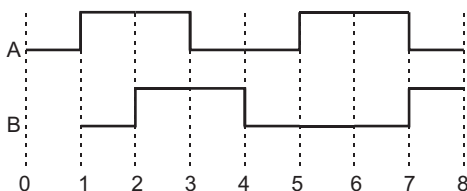

- (ii) If the output of the above AND gate is fed to a NOT gate, name the gate of the combination so formed.
18. A radioactive nucleus ' A ' undergoes a series of decays according to the following scheme : 2
- $$A \xrightarrow{\alpha} A_1 \xrightarrow{\beta} A_2 \xrightarrow{\alpha} A_3 \xrightarrow{\gamma} A_4$$
- The mass number and atomic number of A are 190 and 75 respectively. What are these numbers for A_4 ?
19. State Gauss's law in electrostatics. Use this law to derive an expression for the electric field due to an infinitely long straight wire of linear charge density $\lambda \text{ Cm}^{-1}$. 3

23. Two parallel plate condition X and Y, have the same area of plates and same separation between them. X has air between the plates while Y contains a dielectric medium of $\epsilon_r = 4$.
- Calculate capacitance of each capacitor if equivalent capacitance of the combination is $4 \mu\text{F}$.
 - Calculate the potential difference between the plates of X and Y.
 - What is the ratio of electrostatic energy stored in X and Y?

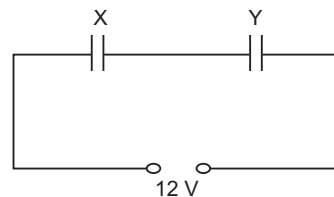

3

Solutions

CBSE (Delhi) SET-I

- Skywave propagation is a mode of propagation in which communication of radiowaves (in the frequency range 30 MHz–40 MHz) takes place due to reflection from the ionosphere.
- Radiowaves, microwaves, UV rays, X-rays.
- Magnetic field lines can be entirely confined within the core of a toroid because **toroid has no ends**. A solenoid is open ended and the field lines inside it which is parallel to the length of the solenoid, cannot form closed curved inside the solenoid.
- An astronomical telescope has an eyepiece of shorter aperture and shorter focal length while an objective of longer aperture and longer focal length.
Therefore, we will use L_3 as eyepiece and L_1 as objective.
- Transmitted intensity, $I_{\text{transmitted}} = \frac{I_0}{2} \cos^2 \theta$

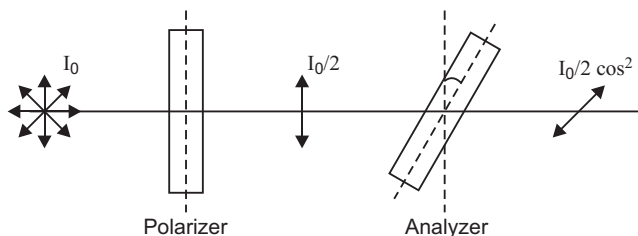

Here $\theta = 45^\circ$

$$\therefore \frac{I_{\text{Original}}}{I_{\text{transmitted}}} = \frac{I_0}{\frac{I_0}{2} \cos^2 45^\circ} = \frac{2}{\cos^2 45^\circ} = \frac{4}{1}$$

- Curves a and b have different intensities but same stopping potential, so curves ' a ' and ' b ' have same frequency but different intensities.
- Wavefront from a point source – spherical
Wavefront from a distant light source – plane.
- Nuclear density is independent of mass number, so ratio 1 : 1.

9. Terminal potential difference, $V = IR = \left(\frac{E}{R+r} \right) R = \frac{E}{1 + \frac{r}{R}}$

When $R \rightarrow 0, V = 0$

When $R = r, V = \frac{E}{2}$

When $R = \infty, V = E$

The graph is shown in fig.

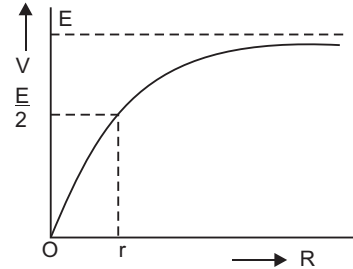

10. (i) No

Reason: At the point of intersection, there will be two different directions of electric field, which is not possible.

(ii) Work done in moving test charge atom P to Q is zero.

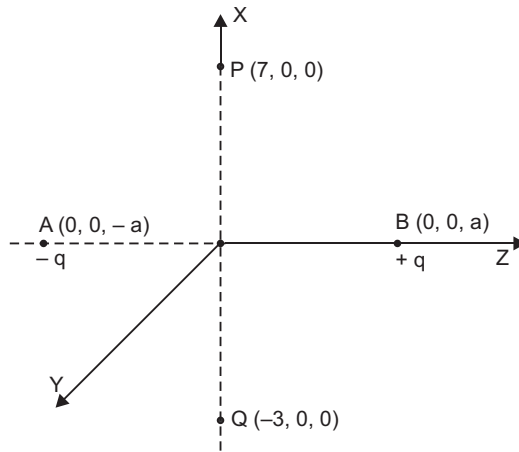

Reason: Test charge is moved along the equatorial line of an electric dipole. As potential at every point on equatorial line is zero, so work done, $W = q_0 (V_Q - V_P) = q_0 (0 - 0) = 0$.

11. Transmission range of a TV tower

$$d = \sqrt{2hR}$$

If height is increased by 21 %, new height, $h' = h + \frac{21}{100} h = 1.21 h$

If d' is the new range, then $\frac{d'}{d} = \sqrt{\frac{h'}{h}} = \sqrt{1.21} = 1.1$

$$\begin{aligned} \text{\% increase in range, } \frac{\Delta d}{d} \times 100\% &= \frac{d' - d}{d} \times 100\% \\ &= \left(\frac{d'}{d} - 1 \right) \times 100\% = (1.1 - 1) \times 100\% = 10\% \end{aligned}$$

12. Consider a metallic conductor XY of length l and cross-sectional area A . A potential difference V is applied across the conductor XY . Due to this potential difference an electric field \vec{E} is produced in the conductor. The magnitude of electric field strength $E = \frac{V}{l}$ and its direction is from Y to X . This electric field exerts a force on free electrons; due to which electrons are accelerated.

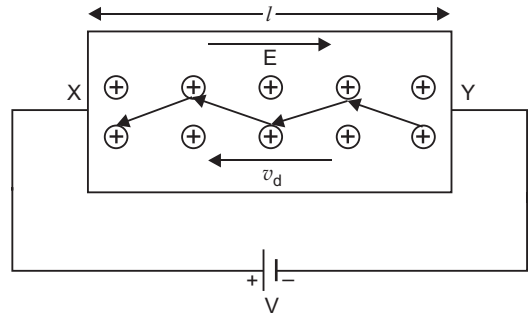

The electric force on electron $\vec{F} = -e\vec{E}$ (where $e = +1.6 \times 10^{-19}$ coulomb).

If m is the mass of electron, then its acceleration

$$\vec{a} = \frac{\vec{F}}{m} = -\frac{e\vec{E}}{m} \quad \dots(1)$$

This acceleration remains constant only for a very short duration, since there are random forces which deflect the electron in random manner. These deflections may arise due to

- (i) ions of metallic crystal vibrate simple harmonically around their mean positions. Different ions vibrate in different directions and may be displaced by different amounts.
- (ii) direct collisions of electrons with atoms of metallic crystal lattice.

In any way after a short duration τ called relaxation time, the motion of electrons become random. Thus, we can imagine that the electrons are accelerated only for a short duration. As average velocity of random motion is zero, if we consider the average motion of an electron, then its initial velocity is zero, so the velocity of electron after time τ (*i.e.*, drift velocity \vec{v}_d) is given by the relation $\vec{v} = \vec{u} + \vec{a}t$ (here $\vec{u} = 0$,

$$\begin{aligned} \vec{v} &= \vec{v}_d, t = \tau, \vec{a} = -\frac{e\vec{E}}{m} \\ \vec{v}_d &= 0 - \frac{e\vec{E}}{m} \tau \\ \Rightarrow \vec{v}_d &= -\frac{e\tau}{m} \vec{E} \quad \dots(2) \end{aligned}$$

At given temperature, the relaxation time τ remains constant, so drift velocity remains constant.

13. An oscillating electric charge produces oscillating electric field, which produces oscillating magnetic field; which in turn produces oscillating electric field and so on; thereby producing an electromagnetic wave propagating in free space.

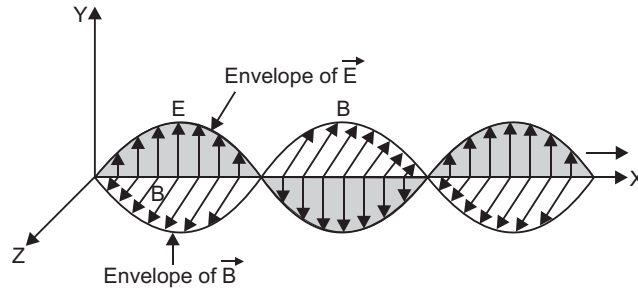

14. (i) The trajectory is shown in fig.
 (ii) No

Reason: Magnetic force $\vec{F}_m = q \vec{v} \times \vec{B}$

Force (\vec{F}_m) is perpendicular to velocity \vec{v} , so work done by the magnetic force on charge is zero; so charge does not gain kinetic energy on entering the magnetic field.

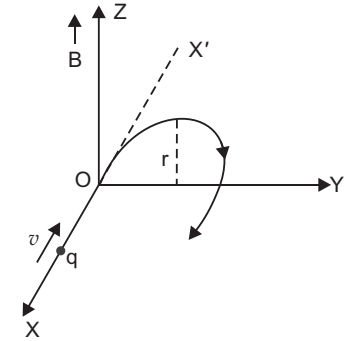

15. The logic gate is **NAND** gate.

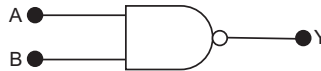

Truth Table

Inputs		Output
A	B	Y
0	0	1
0	1	1
1	0	1
1	1	0

16. **Biot-Savart Law:** It states that the magnetic field strength (dB) produced due to a current element (of current I and length dl) at a point having position vector \vec{r} relative to current element is

$$\vec{dB} = \frac{\mu_0}{4\pi} \frac{I \vec{dl} \times \vec{r}}{r^3}$$

where μ_0 is permeability of free space. Its value is

$$\mu_0 = 4\pi \times 10^{-7} \text{ Wb/A-m.}$$

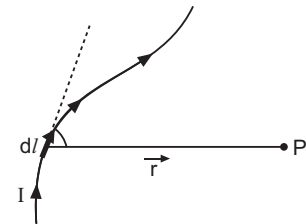

The magnitude of magnetic field is

$$dB = \frac{\mu_0}{4\pi} \frac{Idl \sin \theta}{r^2}$$

where θ is the angle between current element $I \vec{dl}$ and position vector \vec{r} .

The direction of magnetic field \vec{dB} is perpendicular to the plane containing $I \vec{dl}$ and \vec{r} .

The direction of current element is along Z-direction and that of \vec{r} along Y-direction, so magnetic field

$$\vec{B} = \frac{\mu_0}{4\pi} \frac{(I dl \hat{k}) \times (r \hat{j})}{r^3} = \frac{\mu_0}{4\pi} \frac{Idl}{r^2} (-\hat{i}).$$

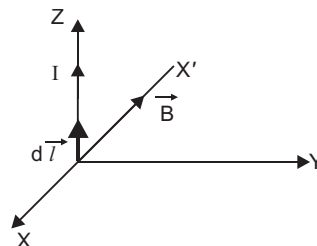

That is magnetic field is directed along negative X-direction.

17. Use of high frequency carrier wave in transmission of signals:

- (i) High frequency carrier wave reduces the size of antenna as $h = \frac{\lambda}{2}$ or $\frac{\lambda}{4}$.
- (ii) High frequency carrier wave radiates more power in space as $P \propto v^2$.
- (iii) High frequency carrier wave avoids mixing up of message signals.

OR

Meaning of Modulation: The original low frequency message/information signal cannot be transmitted over long distances. Therefore, at the transmitter end, information contained in the low frequency message signal, is superimposed on a high frequency carrier signal by a process known as modulation.

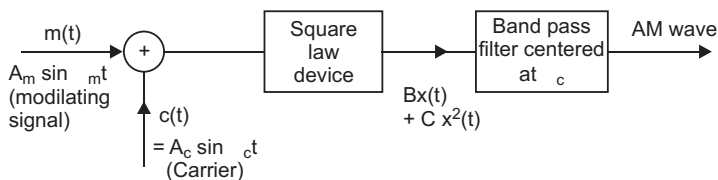

Block diagram of simple modulator

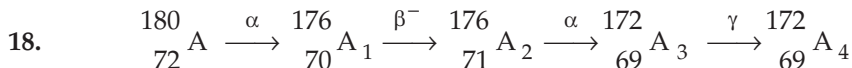

Thus, mass number of A_4 is 172 and atomic number is 69.

- 19. Electric field intensity at a point outside a uniformly charged thin spherical shell:** Consider a uniformly charged thin spherical shell of radius R carrying charge Q . To find the electric field outside the shell, we consider a spherical Gaussian surface of radius $r (> R)$, concentric with given shell. If \vec{E} is electric field outside the shell, then by symmetry electric field strength has same magnitude E_0 on the Gaussian surface and is directed radially

outward. Also the directions of normal at each point is radially outward,

so angle between \vec{E}_i and $d\vec{S}$ is zero at each point. Hence,

$$\begin{aligned} \text{electric flux through Gaussian surface} &= \oint_S \vec{E} \cdot d\vec{S} \\ &= \oint E_0 dS \cos 0 = E_0 \cdot 4\pi r^2 \end{aligned}$$

Now, Gaussian surface is outside the given charged shell, so charge enclosed by Gaussian surface is Q .

Hence, by Gauss's theorem

$$\oint_S \vec{E}_0 \cdot d\vec{E} = \frac{1}{\epsilon_0} \times \text{charged enclosed}$$

$$\Rightarrow E_0 4\pi r^2 = \frac{1}{\epsilon_0} \times Q \Rightarrow E_0 = \frac{1}{4\pi\epsilon_0} \frac{Q}{r^2}$$

Thus, *electric field outside a charged thin spherical shell is the same as if the whole charge Q is concentrated at the centre.*

If σ is the surface charge density of the spherical shell, then

$$Q = 4\pi R^2 \sigma$$

$$\therefore E_0 = \frac{1}{4\pi\epsilon_0} \frac{4\pi R^2 \sigma}{r^2} = \frac{R^2 \sigma}{\epsilon_0 r^2}$$

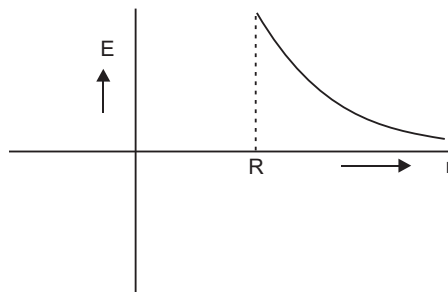
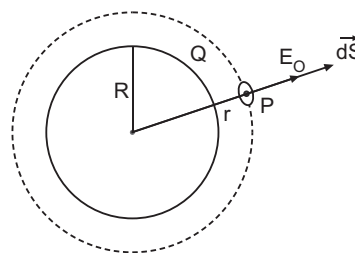

The graph is shown in fig.

20. (i) Capacitors C_1 and C_2 are in series across a 12 V supply while there exists p.d. of 12 V across capacitor C_3 .

Effective Capacitance of C_1 and C_2 is

$$C_{12} = \frac{C_1 C_2}{C_1 + C_2} = \frac{6 \times 6}{6 + 6} = 3 \mu\text{F}$$

Charge on each of capacitors C_1 and C_2 is same:

$$q_1 = q_2 = C_{12} V = (3 \mu\text{F}) \times (12 \text{ V}) = 36 \mu\text{C}$$

Charge on capacitor C_3 , $q_3 = C_3 V$

$$= (6 \mu\text{F} \times 12 \text{ V}) = 72 \mu\text{C}$$

- (ii) Equivalent capacitance of network

$$C_{eq} = C_{12} + C_3 = 3 \mu\text{F} + 6 \mu\text{F} = 9 \mu\text{F}$$

- (iii) Energy stored in the network

$$U = \frac{1}{2} C_{eq} V^2 = \frac{1}{2} \times (9 \times 10^{-6}) \times (12)^2 = 6.48 \times 10^{-4} \text{ J}$$

21. (a) The energy (E) of a photon of wavelength (λ) is given by

$$E = \frac{hc}{\lambda} = \frac{6 \cdot 626 \times 10^{-34} \times 3 \times 10^8}{275 \times 10^{-9}} \text{ J}$$

$$= \frac{6 \cdot 626 \times 10^{-34} \times 3 \times 10^8}{275 \times 10^{-9} \times 1 \cdot 6 \times 10^{-19}} \text{ eV} = 4 \cdot 5 \text{ eV}$$

From fig. this transition corresponds to *B* since for transition *B*.

$$E = 0 - (-4 \cdot 5 \text{ eV}) = 4 \cdot 5 \text{ eV}$$

(b) **Energy of Photon Emitted,** $E = \frac{hc}{\lambda} \propto \frac{1}{\lambda}$

For minimum wavelength of emission, the energy is minimum.

This transition *A* corresponds to emission of radiation of maximum wavelength.

22. (i) de-Broglie wavelength, $\lambda = \frac{h}{\sqrt{2mqV}}$

$$\lambda_p = \frac{h}{\sqrt{2m_p q_p V}}, \quad \lambda_\alpha = \frac{h}{\sqrt{2m_\alpha q_\alpha V}}$$

$$\therefore \frac{\lambda_p}{\lambda_\alpha} = \sqrt{\frac{m_\alpha}{m_p} \cdot \frac{q_\alpha}{q_p}}$$

As $m_\alpha = 4m_p$ and $q_\alpha = 2q_p$

$$\therefore \frac{\lambda_p}{\lambda_\alpha} = \sqrt{4 \times 2} = \sqrt{8} \quad \therefore \lambda_p > \lambda_\alpha$$

i.e., Proton has greater de-Broglie wavelengths.

(ii) Kinetic energy, $K = qV$

$$\frac{K_p}{K_\alpha} = \frac{q_p}{q_\alpha} = \frac{e}{2e} = \frac{1}{2}$$

$$K_p < K_\alpha$$

i.e., proton has less kinetic energy.

23. The waves diffracted at the edge of circular obstacle produce constructive interference at the centre of the shadow; producing a bright spot.

Difference between Interference and Diffraction

	Interference	Diffraction
1.	All bright fringes are of equal intensity.	The central maximum has maximum intensity and the intensity of secondary maxima goes on decreasing with increase of order.
2.	Fringe width of all fringes are equal.	The width of central maximum is maximum and goes on decreasing with increase of order of secondary maxima.

24. (a) The self inductance is defined on the magnetic flux linked with the coil when unit current flows through it.

Or

The self inductance is defined as the emf induced in the coil, when the rate of change of current in the coil is 1 ampere/second.

The SI unit of self-inductance is henry (H).

- (b) **Self Inductance of a long air-cored solenoid:**

Consider a long air solenoid having n number of turns per unit length. If current in solenoid is I , then magnetic field within the solenoid, $B = \mu_0 nI$... (1)

where $\mu_0 = 4\pi \times 10^{-7}$ henry/metre is the permeability of free space.

If A is cross-sectional area of solenoid, then effective flux linked with solenoid of length l ; $\Phi = NBA$ where $N = nl$ is the number of turns in length l of solenoid.

$$\therefore \Phi = (nl BA)$$

Substituting the value of B from (1)

$$\Phi = nl(\mu_0 nI) A = \mu_0 n^2 Al \quad \dots(2)$$

\therefore Self-inductance of air solenoid

$$L = \frac{\Phi}{I} = \mu_0 n^2 Al$$

If N is total number of turns in length l , then

$$n = \frac{N}{l}$$

$$\therefore \text{Self-inductance } L = \mu_0 \left(\frac{N}{l}\right)^2 Al$$

$$= \frac{\mu_0 N^2 A}{l}$$

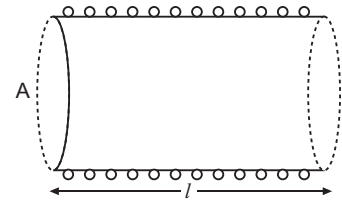

25. Let r = resistance per cm length of bridge wire

$$\frac{X}{Y} = \frac{40r}{(100 - 40)r} \Rightarrow \frac{X}{Y} = \frac{2}{3} \quad \dots(1)$$

When a resistance of 10Ω is connected in series with X , the null point is obtained at $(40 + 10) = 50$ cm.

$$\therefore \frac{X + 10}{Y} = \frac{50r}{50r} \Rightarrow \frac{X + 10}{Y} = 1$$

$$\Rightarrow Y = X + 10 \quad \dots(2)$$

$$\text{From (1), } Y = \frac{3}{2}X \Rightarrow \frac{3}{2}X = X + 10 \Rightarrow X = 20 \Omega$$

$$\therefore \text{From (2), } Y = 20 + 10 = 30 \Omega$$

When a resistance 10Ω is inserted in series with Y , let the balancing length be l_2 .

$$\therefore \frac{X}{Y + 10} = \frac{l_2}{(100 - l_2)}$$

$$\Rightarrow \frac{20}{30+10} = \frac{l_2}{(100-l_2)} \Rightarrow \frac{l_2}{100-l_2} = \frac{l}{2}$$

This gives null point length; $l_2 = 33.3$ cm.

26. Force per unit length between two long straight parallel conductors:

Suppose two long thin straight conductors (or wires) PQ and RS are placed parallel to each other in vacuum (or air) carrying currents I_1 and I_2 respectively. It has been observed experimentally that when the currents in the wire are in the same direction, they experience an attractive force (fig. a) and when they carry currents in opposite directions, they experience a repulsive force (fig. b).

Let the conductors PQ and RS carry currents I_1 and I_2 in same direction and placed at separation r . (fig.).

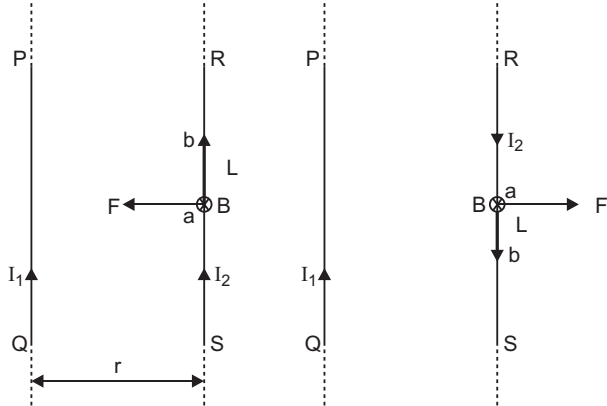

Consider a current-element ' ab ' of length ΔL of wire RS . The magnetic field produced by current-carrying conductor PQ at the location of other wire RS

$$B_1 = \frac{\mu_0 I_1}{2\pi r} \quad \dots(1)$$

According to Maxwell's right hand rule or right hand palm rule no. 1, the direction of B_1 will be perpendicular to the plane of paper and directed downward. Due to this magnetic field, each element of other wire experiences a force. The direction of current element is perpendicular to the magnetic field; therefore the magnetic force on element ab of length ΔL

$$\begin{aligned} \Delta F &= B_1 I_2 \Delta L \sin 90^\circ \\ \therefore &= \frac{\mu_0 I_1}{2\pi r} I_2 \Delta L \end{aligned}$$

\therefore The total force on conductor of length L will be

$$F = \frac{\mu_0 I_1 I_2}{2\pi r} \sum \Delta L = \frac{\mu_0 I_1 I_2}{2\pi r} L$$

\therefore Force acting on per unit length of conductor

$$f = \frac{F}{L} = \frac{\mu_0 I_1 I_2}{2\pi r} \text{ N/m} \quad \dots(2)$$

According to Fleming's left hand rule, the direction of magnetic force will be towards PQ i.e. the force will be attractive.

On the other hand if the currents I_1 and I_2 in wires are in opposite directions, the force will be repulsive. The magnitude of force in each case remains the same.

Definition of Ampere: In S.I. system of fundamental unit of current 'ampere' has been defined assuming the force between the two current carrying wires as standard.

The force between two parallel current carrying conductors of separation r is

$$f = \frac{F}{L} = \frac{\mu_0 I_1 I_2}{2\pi r} \text{ N/m}$$

If $I_1 = I_2 = 1 \text{ A}$, $r = 1 \text{ m}$, then

$$f = \frac{\mu_0}{2\pi} = 2 \times 10^{-7} \text{ N/m}$$

Thus **1 ampere is the current which when flowing in each of parallel conductors placed at separation 1 m in vacuum exert a force of 2×10^{-7} on 1 m length of either wire.**

OR

The cyclotron, devised by Lawrence and Livingston, is a device for accelerating ions to high speed by the repeated application of accelerating potentials.

Principle: The positive ions produced from a source are accelerated. Due to the presence of perpendicular magnetic field the ion will move in a circular path. The phenomenon is continued till the ion reaches at the periphery where an auxiliary negative electrode (deflecting plate) deflects the accelerated ion on the target to be bombarded.

Expression for K.E. attained:

If R be the radius of the path and v_{\max} the velocity of the ion when it leaves the periphery, then

$$v_{\max} = \frac{qBR}{m}$$

The kinetic energy of the ion when it leaves the apparatus is,

$$K.E. = \frac{1}{2} m v_{\max}^2 = \frac{q^2 B^2 R^2}{2m}$$

When charged particle crosses the gap between dees it gains $KE = qV$

In one revolution, it crosses the gap twice, therefore if it completes n -revolutions before emerging the dees, the kinetic energy gained

$$= 2nqV$$

Thus
$$K.E. = \frac{q^2 B^2 R^2}{2m} = 2nqV$$

Working: The principle of action of the apparatus is shown in fig. The positive ions produced from a source S at the centre are accelerated by a dee which is at negative potential at that moment. Due to the presence of perpendicular magnetic field the ion will move in a circular

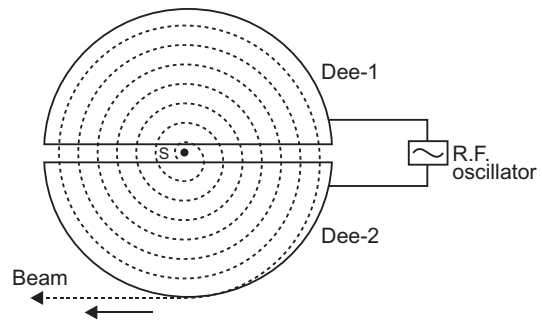
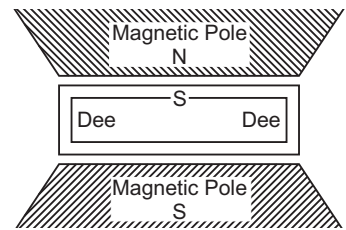

path inside the dees. The magnetic field and the frequency of the applied voltages are so chosen that as the ion comes out of a dee, the dees change their polarity (positive becoming negative and vice-versa) and the ion is further accelerated and moves with higher velocity along a circular path of greater radius. The phenomenon is continued till the ion reaches at the periphery of the dees where an auxiliary negative electrode (deflecting plate) deflects the accelerated ion on the target to be bombarded.

The **function of electric field** is to accelerate the charged particle and so to impart energy to the charged particle.

The function of magnetic field is to provide circular path to charged particle and so to provide the location where charged particle is capable of gaining energy from electric field.

Expression for Period of Revolution and Frequency:

Suppose the positive ion with charge q moves in a dee with a velocity v , then,

$$qvB = \frac{mv^2}{r} \quad \text{or} \quad r = \frac{mv}{qB} \quad \dots(1)$$

where m is the mass and r the radius of the path of ion in the dee and B is the strength of the magnetic field.

The angular velocity ω of the ion is given by,

$$\omega = \frac{v}{r} = \frac{qB}{m} \quad (\text{from equation 1}) \quad \dots(2)$$

The time taken by the ion in describing a semi-circle, *i.e.*, in turning through an angle π is,

$$t = \frac{\pi}{\omega} = \frac{\pi m}{Bq} \quad \dots(3)$$

Thus the time is independent of the speed of the ion *i.e.*, although the speed of the ion goes on increasing with increase in the radius (from eq. 1) when it moves from one dee to the other, yet it takes the same time in each dee.

From eq. (3) it is clear that for a particular ion, $\frac{m}{q}$ being known, B can be calculated for

producing resonance with the high frequency alternating potential.

27. Angle of incidence at face ac for all three colours,

$$i = 45^\circ$$

Refractive index corresponding to critical angle 45° is

$$\mu = \frac{1}{\sin 45^\circ} = \sqrt{2} = 1.414$$

The ray will be transmitted through face 'ac' if $i < i_c$. This condition is satisfied for red colour ($\mu = 1.39$). So only red ray will be transmitted, Blue and Green rays will be totally reflected.

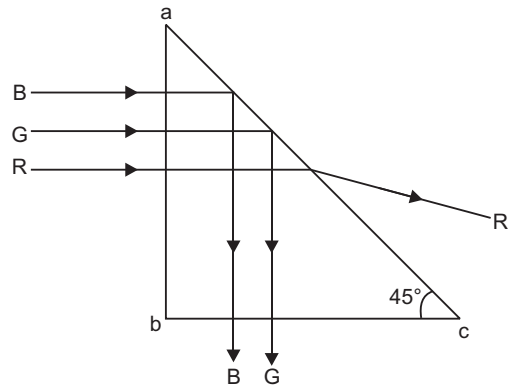

28. (a) In series LCR circuit.

$$\text{Voltage, } V = V_0 \sin \omega t$$

$$\text{Current in circuit, } I = I_0 \sin (\omega t + \phi)$$

$$\text{Instantaneous Power, } P = VI$$

$$= V_0 I_0 \sin \omega t \sin (\omega t + \phi)$$

$$= \frac{1}{2} V_0 I_0 2 \sin \omega t \sin (\omega t + \phi) = \frac{1}{2} V_0 I_0 [\cos \phi - \cos (2\omega t + \phi)]$$

Average value of $\cos (2\omega t + \phi)$ over a complete cycle is zero *i.e.*, $\overline{\cos (2\omega t + \phi)} = 0$.

\therefore Average power over a complete cycle

$$P_{av} = \frac{1}{2} V_0 I_0 \cos \phi = \frac{V_0}{\sqrt{2}} \frac{I_0}{\sqrt{2}} \cos \phi$$

$$P_{av} = V_{rms} I_{rms} \cos \phi$$

(b) Quality Factor (Q): In series LCR circuit the ratio of the voltage drop across inductor (or capacitor) to the voltage drop across resistor under resonance condition is called the quality factor.

$$Q = \frac{\omega_r LI}{RI} = \omega_r \frac{L}{R} = \frac{1}{\sqrt{LC}} \cdot \frac{L}{R}$$

$$\Rightarrow Q = \frac{1}{R} \sqrt{\frac{L}{C}}$$

$$\text{Also, } Q = \frac{\omega_r}{\omega_2 - \omega_1}$$

where $\omega_2 - \omega_1$ = band width of resonant curve. Smaller is the band width, larger is the quality factor and selectivity (or sharpness of resonance) of the circuit.

That is why in receiving circuits, quality factor must be very high. The quality factor depends on the values of resistance, inductance and capacitance of the circuit.

OR

(a) Relationship between Peak and RMS Value of Current:

$$\text{Current } I = I_0 \sin \omega t$$

$$I^2 = I_0^2 \sin^2 \omega t$$

Mean square current over full cycle

$$(I^2)_{mean} = I_0^2 (\sin^2 \omega t)_{mean}$$

Mean value of $\sin^2 \omega t$ over full cycle is $\frac{1}{2}$.

$$\text{i.e., } (\sin^2 \omega t)_{mean} = \frac{\int_0^T \sin^2 \omega t dt}{\int_0^T dt} = \frac{1}{2}$$

$$\therefore (I^2)_{\text{mean}} = I_0^2 \cdot \frac{1}{2}$$

\therefore Root mean square current

$$I_{\text{rms}} = \sqrt{(I^2)_{\text{mean}}} = \frac{I_0}{\sqrt{2}}$$

or $I_{\text{rms}} = 0.707 I_0$

This is required relation.

- (b) Transformer:** Transformer is a device by which an alternating voltage may be decreased or increased. This is based on the principle of mutual induction.

Step up Transformer: It transforms the alternating low voltage to alternating high voltage and in this the number of turns in secondary coil is more than that in primary coil. (i.e., $N_S > N_p$).

Working: When alternating current source is connected to the ends of primary coil, the current changes continuously in the primary coil; due to

which the magnetic flux linked with the secondary coil changes continuously, therefore the alternating emf of same frequency is developed across the secondary.

Let N_p be the number of turns in primary coil, N_S the number of turns in secondary coil and ϕ the magnetic flux linked with each turn. *We assume that there is no leakage of flux so that the flux linked with each turn of primary coil and secondary coil is the same.* According to Faraday's laws the emf induced in the primary coil

$$\varepsilon_p = -N_p \frac{\Delta\phi}{\Delta t} \quad \dots(1)$$

and emf induced in the secondary coil

$$\varepsilon_S = -N_S \frac{\Delta\phi}{\Delta t} \quad \dots(2)$$

From (1) and (2)

$$\frac{\varepsilon_S}{\varepsilon_p} = \frac{N_S}{N_p} \quad \dots(3)$$

If the resistance of primary coil is negligible, the emf (ε_p) induced in the primary coil, will be equal to the applied potential difference (V_p) across its ends. Similarly if the secondary circuit is open, then the potential difference V_S across its ends will be equal to the emf (ε_S) induced in it; therefore

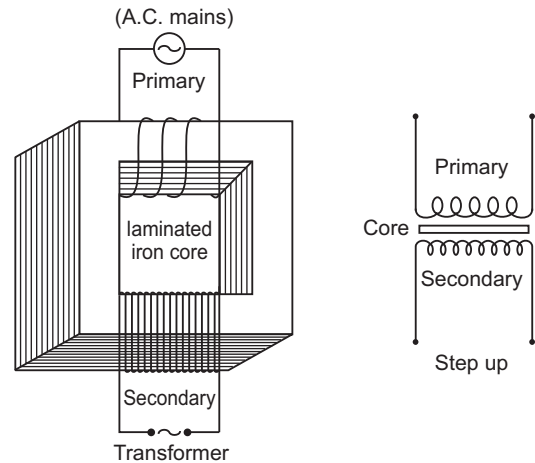

$$\frac{V_S}{V_p} = \frac{\epsilon_S}{\epsilon_p} = \frac{N_S}{N_p} = r \text{ (say)} \quad \dots(4)$$

where $r = \frac{N_S}{N_p}$ is called the *transformation ratio*. If i_p and i_s are the instantaneous currents in

primary and secondary coils and there is no loss of energy; then

For about 100% efficiency, Power in primary = Power in secondary

$$\begin{aligned} V_p i_p &= V_S i_S \\ \therefore \frac{i_S}{i_p} &= \frac{V_p}{V_S} = \frac{N_p}{N_S} = \frac{1}{r} \quad \dots(5) \end{aligned}$$

In step up transformer, $N_s > N_p \rightarrow r > 1$;

So $V_S > V_p$ and $i_S < i_p$

i.e. step up transformer increases the voltage.

When output voltage increases, the output current automatically decreases to keep the power same. Thus, there is no violation of conservation of energy in a step up transformer.

29. (i) **Characteristic Curves:** The circuit diagram for determining the static characteristic curves of an $n-p-n$ transistor in common-emitter configuration is shown in fig.

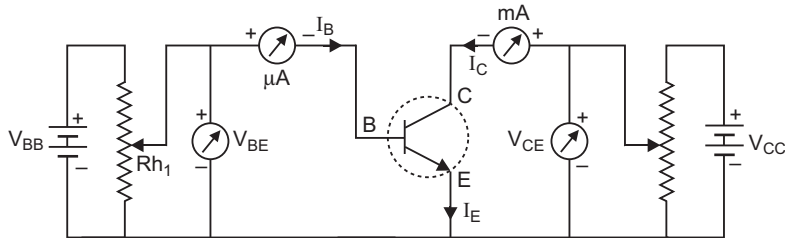

Common Emitter Characteristics:

- (a) **Input characteristics:** These characteristic curves are obtained by plotting base current (I_B) versus base-emitter voltage V_{BE} for fixed collector-emitter voltage V_{CE} . Fig. represents these characteristics.
- (b) **Output characteristics:** These characteristics are obtained by plotting collector current I_C versus collector-emitter voltage V_{CE} at a fixed value of base current I_B . The base current is changed to some other fixed value and the observations of I_C versus V_{CE} are repeated. Fig. represents the output characteristics of a common-emitter circuit.

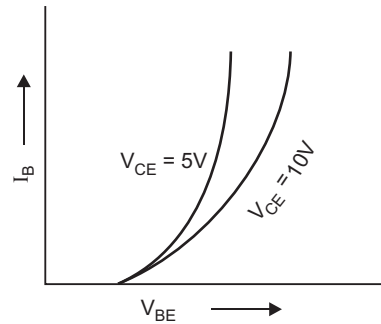

(ii) The circuit of common emitter amplifier using *n-p-n* transistor is shown below:

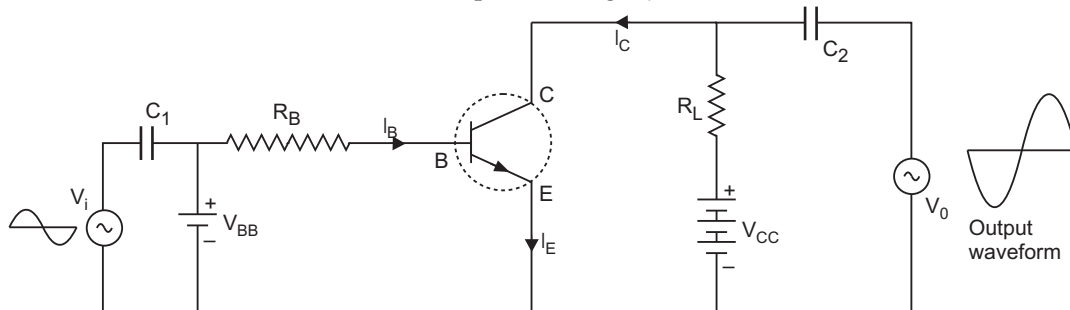

Working: If a small sinusoidal voltage, with amplitude V_S , is superposed on dc basic bias (by connecting the sinusoidal voltage in series with base supply V_{BB}), the base current will have sinusoidal variations superposed on the base current I_B . As a consequence the collector current is also sinusoidal variations superimposed on the value of collector current I_C , this will produce corresponding amplified changes in the value of output voltage V_0 . The a.c. variations across input and output terminals may be measured by blocking the d.c. voltage by large capacitors.

The phase difference between input signal and output voltage is 180° .

The input and output waveforms are shown in figure.

$$\text{Voltage gain } A_v = \beta \frac{R_L}{R_i}$$

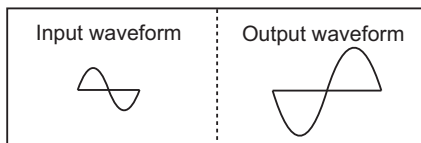

OR

Fabrication: A zener diode is fabricated by heavily doping both *p* and *n* sides of the junction, due to which the depletion layer formed is extremely thin ($< 10^{-6}$ m) and the electric field of the junction is extremely high ($\sim 5 \times 10^6$ V / m) even for small reverse bias voltage of about 5 V.

I-V Characteristics of Zener Diode are shown in figure.

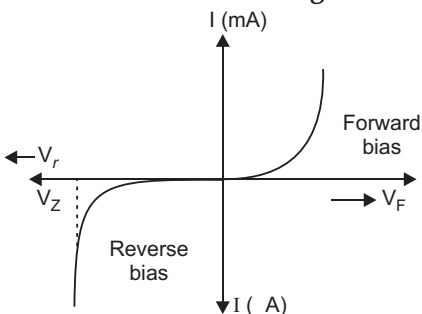

Significance of Breakdown Voltage: After breakdown voltage V_Z , any variation in current through Zener diode, does not cause any change in Zener voltage. This property of Zener diode is used for regulating supply voltages so that they remain constant.

Half Wave Rectifier: The circuit diagram for junction diode as half wave rectifier is shown in Fig.

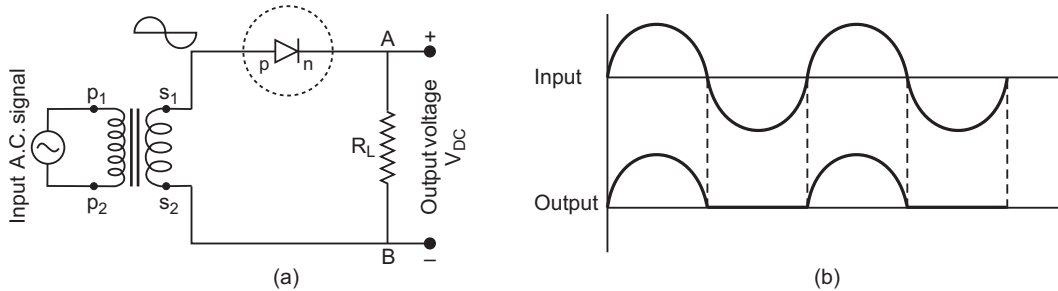

Let during first half the cycle the secondary terminal S_1 of transformer be positive relative to S_2 , then the junction diode is forward biased. Therefore the current flows and its direction in load resistance R_L is from A to B. In next half cycle the terminal S_1 is negative relative to S_2 then the diode is in reverse bias, therefore no current flows in diode and hence there is no potential difference across load R_L . Therefore the output current in load flows only when S_1 is positive relative to S_2 . That is during first half cycles of input a.c. signal there is a current in circuit and hence a potential difference across load resistance R_L while no current flows for next half cycle. The direction of current in load is always from A to B. Thus a *single p-n junction diode acts as a half wave rectifier*.

The input and output waveforms of half wave rectifier are shown in fig. (b).

30. **Relation between u, v, n_1 and n_2 for a spherical surface:** Let SPS' be a spherical refracting surface, which separates media '1' and '2'. Medium '1' is rarer and medium '2' is denser. The refractive indices of media '1' and '2' are n_1 and n_2 respectively ($n_1 < n_2$). Let P be the pole and C the centre of curvature and PC the principal axis of spherical refracting surface.

O is a point-object on the principal axis. An incident ray OA , after refraction at A on the spherical surface bends towards the normal CAN and moves along AB . Another incident ray OP falls on the surface normally and hence passes undeviated after refraction. These two rays, when produced backward meet at point I on principal axis. Thus I is the virtual image of O .

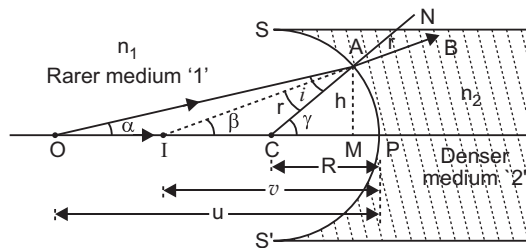

Let angle of incidence of ray OA be i and angle of refraction be r i.e.

$$\angle OAC = i \quad \text{and} \quad \angle NAB = r$$

Let $\angle AOP = \alpha$, $\angle AIP = \beta$ and $\angle ACP = \gamma$

In triangle OAC , $\gamma = \alpha + i$ or $i = \gamma - \alpha$... (1)

In triangle AIC , $\gamma = \beta + r$ or $r = \gamma - \beta$... (2)

From Snell's law
$$\frac{\sin i}{\sin r} = \frac{n_2}{n_1} \quad \dots(3)$$

If point A is very near to P , then angles $i, r, \alpha, \beta, \gamma$ will be very small, therefore $\sin i = i$ and $\sin r = r$

From equation (3)
$$\frac{i}{r} = \frac{n_2}{n_1}$$

Substituting values of i and r from (1) and (2) we get

$$\frac{\gamma - \alpha}{\gamma - \beta} = \frac{n_2}{n_1} \quad \text{or} \quad n_1 (\gamma - \alpha) = n_2 (\gamma - \beta) \quad \dots(4)$$

The length of perpendicular AM dropped from A on the principal axis is h i.e. $AM = h$. As angles α, β and γ are very small, therefore

$$\tan \alpha = \alpha, \quad \tan \beta = \beta, \quad \tan \gamma = \gamma$$

Substituting these values in equation (4)

$$n_1 (\tan \gamma - \tan \alpha) = n_2 (\tan \gamma - \tan \beta) \quad \dots(5)$$

As point A is very close to P , point M is coincident with P

$$\therefore \tan \alpha = \frac{\text{perpendicular}}{\text{base}} = \frac{AM}{MO} = \frac{h}{PO}$$

$$\tan \beta = \frac{AM}{MI} = \frac{h}{PI}, \quad \tan \gamma = \frac{AM}{MC} = \frac{h}{PC}$$

Substituting this value in (5), we get

$$n_1 \left(\frac{h}{PC} - \frac{h}{PO} \right) = n_2 \left(\frac{h}{PC} - \frac{h}{PI} \right)$$

or
$$\frac{n_1}{PC} - \frac{n_1}{PO} = \frac{n_2}{PC} - \frac{n_2}{PI} \quad \dots(6)$$

Let u, v and R be the distances of object O , image I and centre of curvature C from pole P . By sign convention PO, PI and PC are negative i.e. $u = -PO, v = -PI$ and $R = -PC$

Substituting these values in (6), we get

$$\frac{n_1}{(-R)} - \frac{n_1}{(-u)} = \frac{n_2}{(-R)} - \frac{n_2}{(-v)}$$

or
$$\frac{n_1}{R} - \frac{n_1}{u} = \frac{n_2}{R} - \frac{n_2}{v}$$

or
$$\frac{n_2}{v} - \frac{n_1}{u} = \frac{n_2 - n_1}{R}$$

Lens Maker's Formula: Suppose L is a thin lens. The refractive index of the material of lens is n_2 and it is placed in a medium of refractive index n_1 . The optical centre of lens is C and $X'X$ is principal axis. The radii of curvature of the surfaces of the lens are R_1 and R_2 and their

poles are P_1 and P_2 . The thickness of lens is t , which is very small. O is a point object on the principal axis of the lens. The distance of O from pole P_1 is u . The first refracting surface forms the image of O at I' at a distance v' from P_1 . From the refraction formula at spherical surface

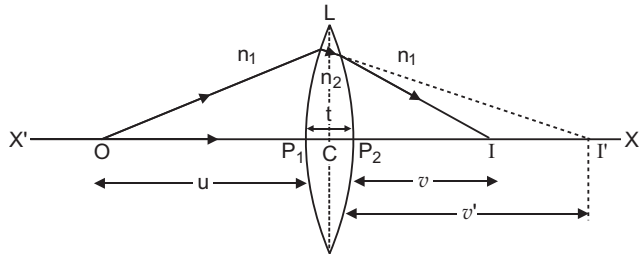

$$\frac{n_2}{v'} - \frac{n_1}{u} = \frac{n_2 - n_1}{R_1} \quad \dots(1)$$

The image I' acts as a virtual object for second surface and after refraction at second surface, the final image is formed at I . The distance of I from pole P_2 of second surface is v . The distance of virtual object (I') from pole P_2 is $(v' - t)$.

For refraction at second surface, the ray is going from second medium (refractive index n_2) to first medium (refractive index n_1), therefore from refraction formula at spherical surface

$$\frac{n_1}{v} - \frac{n_2}{(v' - t)} = \frac{n_1 - n_2}{R_2} \quad \dots(2)$$

For a thin lens t is negligible as compared to v' , therefore from (2)

$$\frac{n_1}{v} - \frac{n_2}{(v')} = -\frac{n_2 - n_1}{R_2} \quad \dots(3)$$

Adding equations (1) and (3), we get

$$\frac{n_1}{v} - \frac{n_1}{u} = (n_2 - n_1) \left(\frac{1}{R_1} - \frac{1}{R_2} \right)$$

or
$$\frac{1}{v} - \frac{1}{u} = \left(\frac{n_2}{n_1} - 1 \right) \left(\frac{1}{R_1} - \frac{1}{R_2} \right)$$

i.e.
$$\frac{1}{v} - \frac{1}{u} = ({}_1n_2 - 1) \left(\frac{1}{R_1} - \frac{1}{R_2} \right) \quad \dots(4)$$

where ${}_1n_2 = \frac{n_2}{n_1}$ is refractive index of second medium (i.e. medium of lens) with respect to first medium.

If the object O is at infinity, the image will be formed at second focus i.e.

if $u = \infty, v = f_2 = f$

Therefore from equation (4)

$$\frac{1}{f} - \frac{1}{\infty} = ({}_1n_2 - 1) \left(\frac{1}{R_1} - \frac{1}{R_2} \right)$$

i.e.
$$\frac{1}{f} = ({}_1n_2 - 1) \left(\frac{1}{R_1} - \frac{1}{R_2} \right) \quad \dots(5)$$

This is the formula of refraction for a thin lens. This formula is called *Lens-Maker's formula*.

If first medium is air and refractive index of material of lens be n , then ${}_1n_2 = n$, therefore equation (5) may be written as

$$\frac{1}{f} = (n - 1) \left(\frac{1}{R_1} - \frac{1}{R_2} \right) \quad \dots(6)$$

OR

Compound Microscope: It consists of a long cylindrical tube, containing at one end a convex lens of small aperture and small focal length. This is called the objective lens (O). At the other end of the tube another co-axial smaller and wide tube is fitted, which carries a convex lens (E) at its outer end. This lens is towards the eye and is called the eye-piece. The focal length and aperture of eyepiece are somewhat larger than those of objective lens. Cross-wires are mounted at a definite distance before the eyepiece. The entire tube can be moved forward and backward by the rack and pinion arrangement.

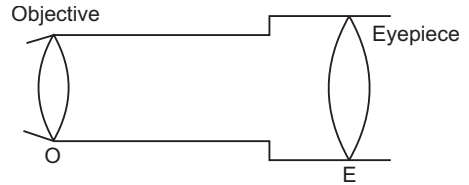

Adjustment: First of all the eyepiece is displaced backward and forward to focus it on cross-wires. Now the object is placed just in front of the objective lens and the entire tube is moved by rack and pinion arrangement until there is no parallax between image of object and cross wire. In this position the image of the object appears quite distinct.

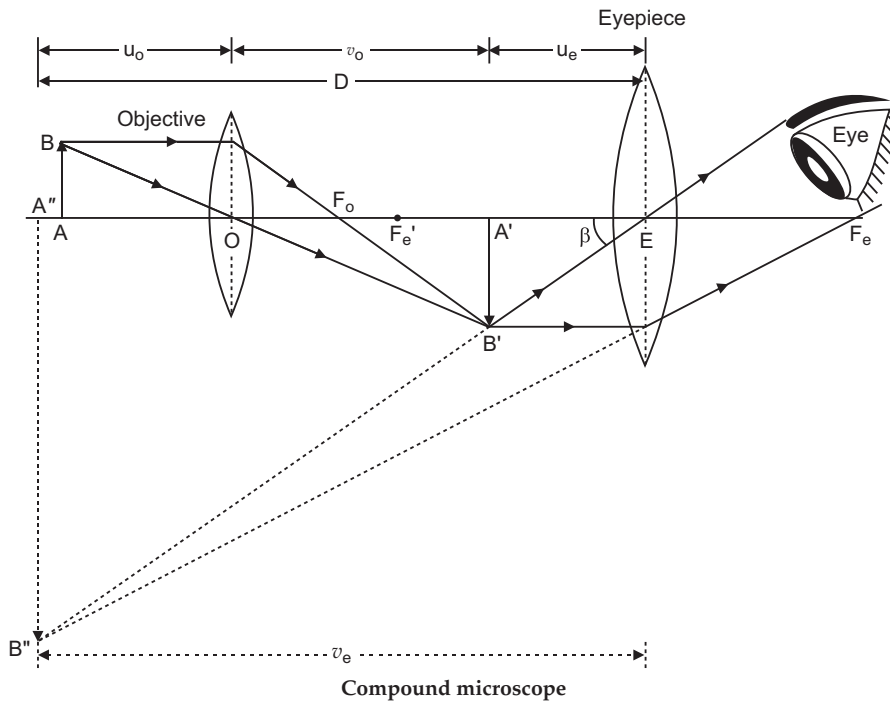

Magnifying power of a microscope is defined as the ratio of angle (β) subtended by final image on the eye to the angle (α) subtended by the object on eye, when the object is placed at the least distance of distinct vision, *i.e.*,

Magnifying power $M = \frac{\beta}{\alpha}$... (1)

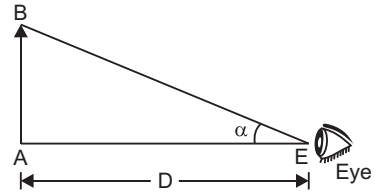

As object is very small, angles α and β are very small and so $\tan \alpha = \alpha$ and $\tan \beta = \beta$. By definition the object AB is placed at the least distance of distinct vision.

$\therefore \alpha = \tan \alpha = \frac{AB}{EA}$

By sign convention $EA = -D$, $\therefore \alpha = \frac{AB}{-D}$

and from figure $\beta = \tan \beta = \frac{A'B'}{EA'}$

If u_e is distance of image $A'B'$ from eye-piece E , then by sign convention, $EA' = -u_e$

and so, $\beta = \frac{A'B'}{(-u_e)}$

Hence magnifying power, $M = \frac{\beta}{\alpha} = \frac{A'B' / (-u_e)}{AB / (-D)} = \frac{A'B'}{AB} \cdot \frac{D}{u_e}$

By sign conventions, magnification of objective lens

$$\frac{A'B'}{AB} = \frac{v_0}{(-u_0)}$$

$\therefore M = -\frac{v_0}{u_0} \cdot \frac{D}{u_e}$... (2)

Using lens formula $\frac{1}{f} = \frac{1}{v} - \frac{1}{u}$ for eye-lens, (*i.e.* using $f = f_e$, $v = -v_e$, $u = -u_e$),

we get $\frac{1}{f_e} = \frac{1}{-v_e} - \frac{1}{(-u_e)}$ or $\frac{1}{u_e} = \frac{1}{f_e} + \frac{1}{v_e}$

Magnifying power $M = -\frac{v_0}{u_0} D \left(\frac{1}{f_e} + \frac{1}{v_e} \right)$

or $M = -\frac{v_0}{u_0} \left(\frac{D}{f_e} + \frac{D}{v_e} \right)$

When final image is formed at the distance of distinct vision, $v_e = D$

\therefore Magnification, $M = -\frac{v_0}{u_0} \left(1 + \frac{D}{f_e} \right)$

For greater magnification of a compound microscope, f_e should be small. As $f_0 < f_e$, so f_0 is small. Hence, for greater magnification both f_0 and f_e should be small.

CBSE (Delhi) SET-II

1. Microwave

Use: Microwave oven or Radar.

2. **Ground Wave Propagation:** Ground wave propagation is one in which electromagnetic waves glide on the surface of earth between two antennas on the ground.

5. $\mu = \tan i$

6. The behaviour of a thin convex lens is shown in figure.

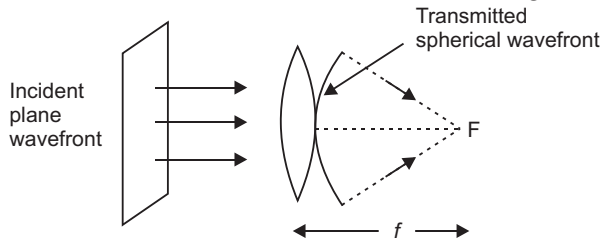

8. Nuclear density is independent of mass number, so ratio of nuclear densities is 1 : 1.

11. Name of combination: NAND gate logic symbol.



Truth Table of NAND gate is

Inputs		Output
A	B	Y
0	0	1
1	0	1
0	1	1
1	1	0

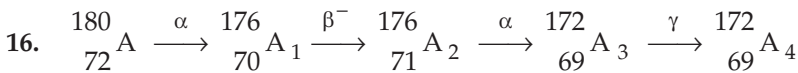

The mass number of A is 180 and atomic number is 72.

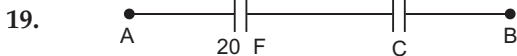

(i) Given $C_{AB} = 4 \mu\text{F}$

Capacitance $20 \mu\text{F}$ and $C (\mu\text{F})$ are in series

$$\therefore C_{AB} = \frac{C \times 20}{C + 20}$$

$$\Rightarrow 4 \mu\text{F} = \frac{20 C}{C + 20} \quad \text{or} \quad 4C + 80 = 20 C$$

$$\Rightarrow 16C = 80 \quad \text{or} \quad C = 5 \mu\text{F}$$

(ii) Charge on each capacitor, $Q = C_{AB}V$
 $= (4 \mu\text{F}) \times (12 \text{ V}) = 48 \mu\text{C}$

(iii) Potential drop across $20 \mu\text{F}$ capacitor
 $V_1 = \frac{Q}{20 \mu\text{F}} = \frac{48 \mu\text{C}}{20 \mu\text{F}} = 2.4 \text{ V}$

Potential drop across C , $V_2 = \frac{Q}{C} = \frac{48 \mu\text{C}}{5 \mu\text{F}} = 9.6 \text{ V}$

20. **Gauss Theorem:** The net outward electric flux through a closed surface is equal to $\frac{1}{\epsilon_0}$ times the net charge enclosed within the surface *i.e.*,

$$\oint_S \vec{E} \cdot d\vec{S} = \frac{1}{\epsilon_0} \Sigma q$$

Let electric charge be uniformly distributed over the surface of a thin, non-conducting infinite sheet. Let the surface charge density (*i.e.*, charge per unit surface area) be σ . We have to calculate the electric field strength at any point distance r from the sheet of charge.

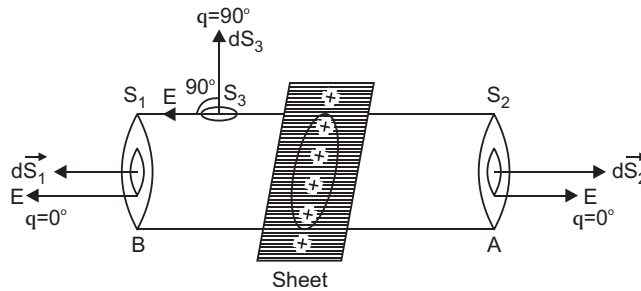

To calculate the electric field strength near the sheet, we now consider a cylindrical Gaussian surface bounded by two plane faces A and B lying on the opposite sides and parallel to the charged sheet and the cylindrical surface perpendicular to the sheet (fig). By symmetry the electric field strength at every point on the flat surface is the same and its direction is normal outwards at the points on the two plane surfaces and parallel to the curved surface.

Total electric flux

$$\oint_S \vec{E} \cdot d\vec{S} = \oint_{S_1} \vec{E} \cdot d\vec{S}_1 + \oint_{S_2} \vec{E} \cdot d\vec{S}_2 + \oint_{S_3} \vec{E} \cdot d\vec{S}_3$$

or
$$\oint_S \vec{E} \cdot d\vec{S} = \int_{S_1} E dS_1 \cos 0^\circ + \int_{S_2} E dS_2 \cos 0^\circ + \int_{S_3} E dS_3 \cos 90^\circ$$

$$= E \int dS_1 + E \int dS_2 = E a + E a = 2E a$$

\therefore Total electric flux = $2E a$.

As σ is charge per unit area of sheet and a is the intersecting area, the charge enclosed by Gaussian surface = σa

According to Gauss's theorem,

$$\text{Total electric flux} = \frac{1}{\epsilon_0} \times (\text{total charge enclosed by the surface})$$

$$\text{i.e.,} \quad 2Ea = \frac{1}{\epsilon_0} (\sigma a)$$

$$\therefore E = \frac{\sigma}{2\epsilon_0}.$$

Thus electric field strength due to an infinite flat sheet of charge is independent of the distance of the point and is directed normally away from the charge. If the surface charge density σ is negative the electric field is directed towards the surface charge.

22. de-Broglie wavelength, $\lambda = \frac{h}{\sqrt{2mqV}}$

For electron $q = e, m = m_e$, $\lambda_e = \frac{h}{\sqrt{2m_e \cdot eV}}$

For proton, $q = e, m = m_p$, $\lambda_p = \frac{h}{\sqrt{2m_p eV}}$

$$\therefore \frac{\lambda_e}{\lambda_p} = \sqrt{\frac{m_p}{m_e}}$$

(i) As $m_e > m_p$, $\lambda_e > \lambda_p$ i.e., electron has greater de-Broglie wavelength.

$$\text{Momentum, } p = \sqrt{2meV} \propto \sqrt{m}$$

(ii) As $m_e < m_p$; $p_e < p_p$ **so electron has less momentum.**

CBSE (Delhi) SET-III

2. The reflected and refracted rays are mutually perpendicular at polarising angle; so from Brewster's law

$$i_p = \tan^{-1}(n) = \tan^{-1}(\sqrt{3}) = 60^\circ.$$

3. **Space Wave Propagation:** It is the straight line propagation of electromagnetic wave from transmitting antenna to receiving antenna both installed on the ground.

Alternatively, space wave propagation is the line of sight (LOS) communication.

5. (i) Microwave

(ii) γ -rays.

6. Nuclear density is independent of mass number so ratio is 1 : 1.

7. A wavefront is a surface of constant phase. A ray is a perpendicular line drawn at any point on wavefront and represents the direction of propagation of the wave.

12. (i) Output waveform of AND gate is shown in fig. (output is 1 when both inputs are 1).

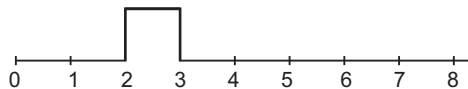

(ii) NAND gate.

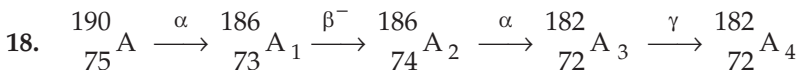

The mass number of A_4 is 182 and atomic number is 72.

19. Gauss Theorem: The net outward electric flux through a closed surface is equal to $\frac{1}{\epsilon_0}$ times the net charge enclosed within the surface *i.e.*,

$$\oint_S \vec{E} \cdot d\vec{S} = \frac{1}{\epsilon_0} \Sigma q$$

Electric field due to infinitely long, thin and uniformly charged straight wire: Consider an infinitely long line charge having linear charge density λ coulomb metre⁻¹ (linear charge density means charge per unit length). To find the electric field strength at a distance r , we consider a cylindrical Gaussian surface of radius r and length l coaxial with line charge. The cylindrical Gaussian surface may be divided into three parts :

(i) Curved surface S_1 (ii) Flat surface S_2 and (iii) Flat surface S_3 .

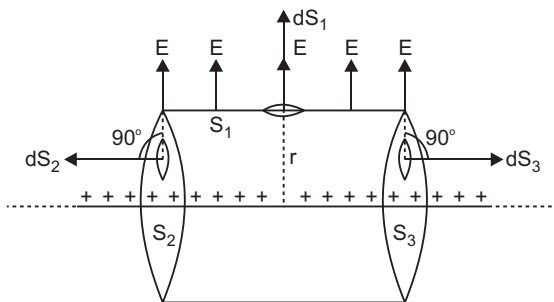

By symmetry the electric field has the same magnitude E at each point of curved surface S_1 and is directed radially outward.

We consider small elements of surfaces S_1 , S_2 and S_3 . The surface element vector $d\vec{S}_1$ is directed along the direction of electric field (*i.e.*, angle between \vec{E} and $d\vec{S}_1$ is zero); the elements $d\vec{S}_2$ and $d\vec{S}_3$ are directed perpendicular to field vector \vec{E} (*i.e.*, angle between $d\vec{S}_2$ and \vec{E} is 90° and so also angle between $d\vec{S}_3$ and \vec{E}).

Electric Flux through the cylindrical surface

$$\begin{aligned}
 \oint_S \vec{E} \cdot d\vec{S} &= \int_{S_1} \vec{E} \cdot d\vec{S}_1 + \int_{S_2} \vec{E} \cdot d\vec{S}_2 + \int_{S_3} \vec{E} \cdot d\vec{S}_3 \\
 &= \int_{S_1} E dS_1 \cos 0^\circ + \int_{S_2} E dS_2 \cos 90^\circ + \int_{S_3} E dS_3 \cos 90^\circ \\
 &= \int_S E dS_1 + 0 + 0 \\
 &= E \int dS_1 \quad (\text{since electric field } E \text{ is the same} \\
 &\quad \text{at each point of curved surface}) \\
 &= E 2\pi rl \quad (\text{since area of curved surface} = 2\pi rl)
 \end{aligned}$$

As λ is charge per unit length and length of cylinder is l , therefore, charge enclosed by assumed surface = (λl)

\therefore By Gauss's theorem

$$\oint \vec{E} \cdot d\vec{S} = \frac{1}{\epsilon_0} \times \text{charge enclosed}$$

$$\Rightarrow E \cdot 2\pi rl = \frac{1}{\epsilon_0} (\lambda l)$$

$$\Rightarrow E = \frac{\lambda}{2\pi\epsilon_0 r}$$

Thus, the electric field strength due to a line charge is inversely proportional to r .

23. (i) Capacitance of X, $C_X = \frac{\epsilon_0 A}{d}$

Capacitance of Y, $C_Y = \frac{\epsilon_r \epsilon_0 A}{d} = 4 \frac{\epsilon_0 A}{d}$

$$\therefore \frac{C_Y}{C_X} = 4 \quad \Rightarrow C_Y = 4C_X \quad \dots(1)$$

As X and Y are in series, so

$$C_{eq} = \frac{C_X C_Y}{C_X + C_Y}$$

$$\Rightarrow 4\mu F = \frac{C_X \cdot 4C_X}{C_X + 4C_X} \Rightarrow C_X = 5\mu F \quad \text{and } C_Y = 4C_X = 20\mu F$$

(ii) In series charge on each capacitor is same, so

$$\text{P.d. } V = \frac{Q}{C} \propto \frac{1}{C}$$

$$\therefore \frac{V_X}{V_Y} = \frac{C_Y}{C_X} = 4 \quad \Rightarrow V_X = 4V_Y \quad \dots(2)$$

Also $V_X + V_Y = 12 \quad \dots(3)$

From (1) and (2),

$$4V_Y + V_Y = 12$$

$$\Rightarrow V_Y = 2.4V$$

$$\therefore V_X = 4 \times 2.4 = 9.6 \text{ V}$$

Thus potential difference across X, $V_X = 9.6 \text{ V}$, P.d. across Y, $V_Y = 2.4 \text{ V}$

$$(ii) \frac{\text{Energy stored in X}}{\text{Energy stored in Y}} = \frac{Q^2 / 2C_X}{Q^2 / 2C_Y} = \frac{C_Y}{C_X} = 4$$

$$\Rightarrow \frac{U_X}{U_Y} = 4$$

CBSE EXAMINATION PAPERS

ALL INDIA-2009

Time allowed : 3 hours

Maximum marks : 70

General Instructions:

- All questions are compulsory.
- There are 30 questions in total. Questions 1 to 8 carry one mark each, questions 9 to 18 carry two marks each, questions 19 to 27 carry three marks each and questions 28 to 30 carry five marks each.
- There is no overall choice. However, an internal choice has been provided in one question of two marks, one question of three marks and all three questions of five marks each. You have to attempt only one of the given choices in such questions.
- Use of calculators is not permitted.
- You may use the following values of physical constants wherever necessary:

$$c = 3 \times 10^8 \text{ ms}^{-1}$$

$$h = 6.626 \times 10^{-34} \text{ Js}$$

$$e = 1.602 \times 10^{-19} \text{ C}$$

$$\mu_0 = 4\pi \times 10^{-7} \text{ TmA}^{-1}$$

$$\frac{1}{4\pi\epsilon_0} = 9 \times 10^9 \text{ Nm}^2\text{C}^{-2}$$

$$\text{Boltzmann's constant } k = 1.381 \times 10^{-23} \text{ JK}^{-1}$$

$$\text{Avogadro's number } N_A = 6.022 \times 10^{23} \text{ /mole}$$

$$\text{Mass of neutron } m_n = 1.2 \times 10^{-27} \text{ kg}$$

$$\text{Mass of electron } m_e = 9.1 \times 10^{-31} \text{ kg}$$

$$\text{Radius of earth} = 6400 \text{ km}$$

CBSE (All India) SET-I

- What is the electrostatic potential due to an electric dipole at an equatorial point? 1
- Name the EM waves used for studying crystal structure of solids. What is its frequency range? 1
- An electron does not suffer any deflection while passing through a region of uniform magnetic field. What is the direction of the magnetic field? 1
- How would the angular separation of interference fringes in Young's double slit experiment change when the distance between the slits and screen is doubled? 1
- Two thin lenses of power +6 D and - 2 D are in contact. What is the focal length of the combination? 1
- The stopping potential in an experiment on photoelectric effect is 1.5 V. What is the maximum kinetic energy of the photoelectrons emitted? 1
- Two nuclei have mass numbers in the ratio 1 : 8. What is the ratio of their nuclear radii? 1
- Give the logic symbol of NOR gate. 1

9. Draw 3 equipotential surfaces corresponding to a field that uniformly increases in magnitude but remains constant along Z-direction. How are these surfaces different from that of a constant electric field along Z-direction? 2

10. Define electric flux. Write its S.I. units.

A charge q is enclosed by a spherical surface of radius R . If the radius is reduced to half, how would the electric flux through the surface change 2

11. Define refractive index of a transparent medium.

A ray of light passes through a triangular prism. Plot a graph showing the variation of the angle of deviation with the angle of incidence. 2

12. Calculate the current drawn from the battery in the given network. 2

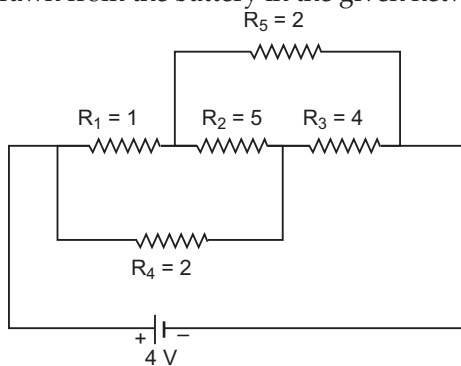

13. Answer the following questions : 1

(a) Optical and radio telescopes are built on the ground while X-ray astronomy is possible only from satellites orbiting the Earth. Why?

(b) The small ozone layer on top of the stratosphere is crucial for human survival. Why?

14. Define current sensitivity and voltage sensitivity of a galvanometer.

Increasing the current sensitivity may not necessarily increase the voltage sensitivity of a galvanometer. Justify. 2

15. Define the term 'linearly polarised light.'

When does the intensity of transmitted light become maximum, when a polaroid sheet is rotated between two crossed polaroids? 2

16. A wire of 15Ω resistance is gradually stretched to double its original length. It is then cut into two equal parts. These parts are then connected in parallel across a 3.0 volt battery. Find the current drawn from the battery. 2

17. (a) The mass of a nucleus in its ground state is always less than the total mass of its constituents – neutrons and protons. Explain.

(b) Plot a graph showing the variation of potential energy of a pair of nucleons as a function of their separation. 2

18. Write the function of (i) Transducer and (ii) Repeater in the context of communication system.

OR

Write two factors justifying the need of modulation for transmission of a signal. 2

19. A positive point charge (+ q) is kept in the vicinity of an uncharged conducting plate. Sketch electric field lines originating from the point on to the surface of the plate.
Derive the expression for the electric field at the surface of a charged conductor. **3**

OR

A parallel plate capacitor is charged by a battery. After some time the battery is disconnected and a dielectric slab of dielectric constant K is inserted between the plates. How would (i) the capacitance, (ii) the electric field between the plates and (iii) the energy stored in the capacitor, be affected? Justify your answer. **2**

20. (i) State the principle of working of a meter bridge.
(ii) In a meter bridge balance point is found at a distance l_1 with resistance R and S as shown in the figure.
When an unknown resistance X is connected in parallel with the resistance S , the balance point shifts to a distance l_2 . Find the expression for X in terms of l_1 , l_2 and S . **3**

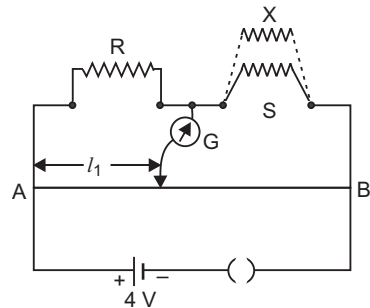

21. (i) State Faraday's law of electromagnetic induction.
(ii) A jet plane is travelling towards west at a speed of 1800 km/h. What is the voltage difference developed between the ends of the wing having a span of 25 m, if the Earth's magnetic field at the location has a magnitude of 5×10^{-4} T and the dip angle of 30° ?
22. In Young's double slit experiment, monochromatic light of wavelength 630 nm illuminates the pair of slits and produces an interference pattern in which two consecutive bright fringes are separated by 8.1 mm. Another source of monochromatic light produces the interference pattern in which the two consecutive bright fringes are separated by 7.2 mm. Find the wavelength of light from the second source.
What is the effect on the interference fringes if the monochromatic source is replaced by a source of white light? **3**
23. Draw a schematic arrangement of the Geiger-Marsden experiment. How did the scattering of α -particles of a thin foil of gold provide an important way to determine an upper limit on the size of the nucleus? Explain briefly. **3**
24. Distinguish between sky wave and space wave propagation. Give a brief description with the help of suitable diagrams indicating how these waves are propagated.
25. With the help of a suitable diagram, explain the formation of depletion region in a p - n junction. How does its width change when the junction is (i) forward biased, and (ii) reverse biased? **3**
26. Give a circuit diagram of a common emitter amplifier using an n - p - n transistor. Draw the input and output waveforms of the signal. Write the expression for its voltage gain. **3**
27. Draw a plot showing the variation of binding energy per nucleon versus the mass number A . Explain with the help of this plot the release of energy in the processes of nuclear fission and fusion. **3**
28. Draw a schematic sketch of a cyclotron. Explain briefly how it works and how it is used to accelerate the charged particles.
(i) Show that time period of ions in a cyclotron is independent of both the speed and radius of circular path.

- (ii) What is resonance condition? How is it used to accelerate the charged particles? 5

OR

- (a) Two straight long parallel conductors carry currents I_1 and I_2 in the same direction. Deduce the expression for the force per unit length between them.

Depict the pattern of magnetic field lines around them.

- (b) A rectangular current carrying loop $EFGH$ is kept in a uniform magnetic field as shown in the fig.

(i) What is the direction of the magnetic moment of the current loop?

(ii) When is the torque acting on the loop (a) maximum, (b) zero? 5

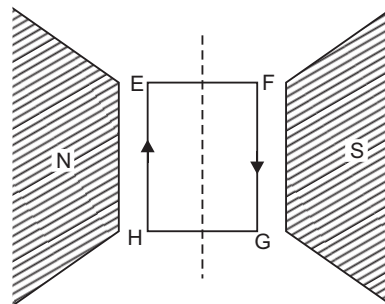

29. (a) What are eddy currents? Write their two applications.

- (b) Figure shows a rectangular conducting loop $PQRS$ in which arm RS of length l is movable. The loop is kept in a uniform magnetic field ' B ' directed downward perpendicular to the plane of the loop. The arm RS is moved with a uniform speed ' v '.

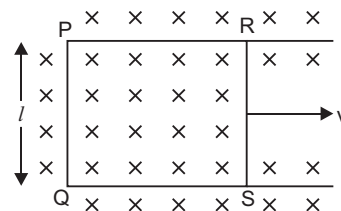

Deduce an expression for :

- (i) the emf induced across the arm ' RS ',
 (ii) the external force required to move the arm, and
 (iii) the power dissipated as heat. 5

OR

- (a) State Lenz's law. Give one example to illustrate this law. "The Lenz's law is a consequence of the principle of conservation of energy." Justify this statement.

- (b) Deduce an expression for the mutual inductance of two long co-axial solenoids but having different radii and different number of turns. 5

30. (a) (i) Draw a labelled ray diagram to show the formation of image in an astronomical telescope for a distant object.

(ii) Write three distinct advantages of a reflecting type telescope over a refracting type telescope.

- (b) A convex lens of focal length 10 cm is placed coaxially 5 cm away from a concave lens of focal length 10 cm. If an object is placed 30 cm in front of the convex lens, find the position of the final image formed by the combined system. 5

OR

- (a) With the help of a suitable ray diagram, derive the mirror formula for a concave mirror.

- (b) The near point of a hypermetropic person is 50 cm from the eye. What is the power of the lens required to enable the person to read clearly a book held at 25 cm from the eye? 5

CBSE (All India) SET-II**Questions different from Set-I.**

1. What is the work done in moving a test charge q through a distance of 1 cm along the equatorial axis of an electric dipole? 1
5. Two thin lenses of power + 4 D and -2 D are in contact. What is the focal length of the combination? 1
6. Give the logic symbol of NAND gate. 1
7. Two nuclei have mass numbers in the ratio 8 : 125. What is the ratio of their nuclear radii? 1
8. The maximum kinetic energy of a photoelectron is 3 eV. What is its stopping potential? 1
9. (i) State the principle on which the working of an optical fiber is based.
(ii) What are the necessary conditions for this phenomenon to occur? 2
21. (i) State the law that gives the polarity of the induced emf.
(ii) A $15 \cdot 0 \mu\text{F}$ capacitor is connected to 220 V, 50 Hz source. Find the capacitive reactance and the rms current.
22. (a) In a single slit diffraction experiment, a slit of width ' d ' is illuminated by red light of wavelength 650 nm. For what value of ' d ' will:
 - (i) the first minimum fall at an angle of diffraction of 30° , and
 - (ii) the first maximum fall at an angle of diffraction of 30° ?
 (b) Why does the intensity of the secondary maximum become less as compared to the central maximum? 3
23. Use Gauss's law to derive the expression for the electric field between two uniformly charged large parallel sheets with surface charge densities σ and $-\sigma$ respectively. 3

OR

- (a) A charge $+Q$ is placed on a large spherical conducting shell of radius R . Another small conducting sphere of radius r carrying charge ' q ' is introduced inside the large shell and is placed at its centre. Find the potential difference between two points, one lying on the sphere and the other on the shell.
- (b) How would the charge between the two flow if they are connected by a conducting wire? Name the device which works on this fact. 3
25. (i) With the help of circuit diagrams distinguish between forward biasing and reverse biasing of a $p-n$ junction diode.
(ii) Draw $V-I$ characteristics of a $p-n$ junction diode in (a) forward bias, (b) reverse bias. 3

CBSE (All India) Set-III**Questions different from Set-I and Set-II.**

1. Define the term 'potential energy' of charge ' q ' at a distance ' r ' in an external electric field. 1

4. The stopping potential in an experiment on photoelectric effect is 2 V. What is the maximum kinetic energy of the photoelectrons emitted? 1
5. Two thin lenses of power +5 D and -2.5 D are in contact. What is the focal length of the combination? 1
7. Give the logic symbol of AND gate. 1
8. Two nuclei have mass numbers in the ratio 27 : 125. What is the ratio of their nuclear radii? 1
11. (i) What is the relation between critical angle and refractive index of a material?
(ii) Does critical angle depend on the colour of light? Explain. 2
16. A wire of $20\ \Omega$ resistance is gradually stretched to double its original length. It is then cut into two equal parts. These parts are then connected in parallel across a 4.0 volt battery. Find the current drawn from the battery. 2
22. In Young's double slit experiment, monochromatic light of wavelength 600 nm illuminates the pair of slits and produces an interference pattern in which two consecutive bright fringes are separated by 10 mm . Another source of monochromatic light produces the interference pattern in which the two consecutive bright fringes are separated by 8 mm . Find the wavelength of light from the second source.
What is the effect on the interference fringes if the monochromatic source is replaced by a source of white light? 3
25. Explain with the help of a circuit diagram how a zener diode works as a DC voltage regulator. Draw its I - V characteristics. 3
27. Define the activity of a radionuclide. Write its S.I. units. Give a plot of the activity of a radioactive species versus time.
How long will a radioactive isotope, whose half life is T years, take for its activity to reduce to $1/8$ th of its initial value? 3

Solutions

CBSE (All India) SET-I

- Zero,
- X-Rays

Frequency range : $3 \times 10^{16}\text{ Hz} - 3 \times 10^{19}\text{ Hz}$.

- Magnetic field is parallel or antiparallel to velocity of electron *i.e.*, angle between \vec{v} and \vec{B} is 0° or 180° .
- Angular separation between fringes

$$\beta_\theta = \frac{\lambda}{d}$$

where λ = wavelength, d = separation between coherent sources, β_θ is independent of distance between the slits and screen; so angular separation (β_θ) will remain unchanged.

5. Net power of lens combination $P = +6 D - 2 D = +4 D$

$$\therefore \text{Focal length, } F = \frac{1}{P} = \frac{1}{4} \text{ m} = \mathbf{25 \text{ cm}}$$

6. $K_{\max} = eV_s = e(1.5 \text{ V}) = 1.5 \text{ eV}$
 $= 1.5 \times 1.6 \times 10^{-19} \text{ J} = \mathbf{2.4 \times 10^{-19} \text{ J}}$

7. Nuclear radius, $R = R_0 A^{1/3}$

$$\therefore \frac{R_1}{R_2} = \left(\frac{A_1}{A_2} \right)^{1/3} = \left(\frac{1}{8} \right)^{1/3} = \frac{1}{2}$$

8. Symbol of NOR gate.

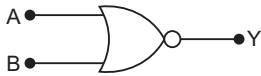

9. For constant electric field \vec{E}

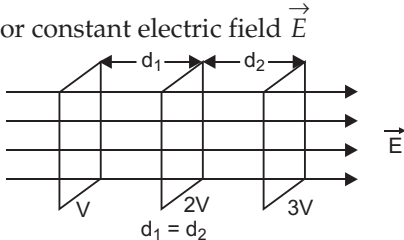

For increasing electric field

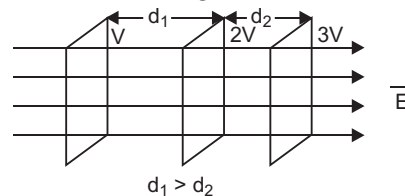

Difference: For constant electric field, the equipotential surfaces are equidistant for same potential difference between these surfaces; while for increasing electric field, the separation between these surfaces decreases, in the direction of increasing field, for the same potential difference between them.

10. **Electric Flux:** The total number of electric lines of force diverging normally from a surface is called the electric flux through that surface.

S.I. unit of electric flux is volt metre.

Electric flux through surface element $\Delta \vec{S}$ is $\Delta \phi = \vec{E} \cdot \Delta \vec{S}$
 $= E \Delta S \cos \theta$, where \vec{E} is electric field strength.

Electric flux through entire closed surface is

$$\phi = \int_S \vec{E} \cdot d\vec{S}$$

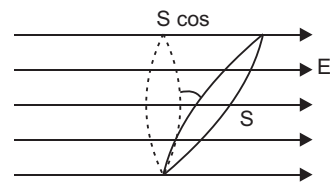

As electric flux through the surface $= \frac{1}{\epsilon_0} \times q$

On decreasing the radius of the spherical surface to half there will be no effect on the electric flux.

11. **Refractive Index :** Refractive index of a medium is the ratio of speed of light in vacuum to the speed of light in medium *i.e.*, $n = \frac{c}{v}$.

Alternatively : It is defined as the ratio of sine of angle of incidence to the sine of angle of refraction in medium *i.e.*,

$$n = \frac{\sin i}{\sin r}$$

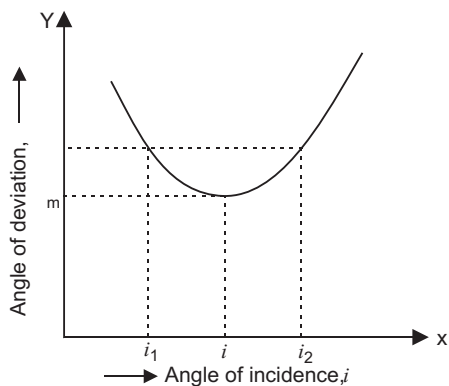

12. The equivalent circuit is shown in fig.
The five resistors form a balanced Wheatstone's bridge. Since

$$\frac{R_1}{R_5} = \frac{R_4}{R_3}$$

So, R_2 is ineffective.

The effective resistance of R_1 and R_5 in series,

$$R' = R_1 + R_5 = 1 + 2 = 3 \Omega$$

The effective resistance of R_4 and R_3 in series is

$$R'' = R_4 + R_3 = 2 + 4 = 6 \Omega$$

∴ Equivalent resistance of network between A and B

$$R_{AB} = \frac{R' R''}{R' + R''} = \frac{3 \times 6}{3 + 6} = 2 \Omega$$

Current drawn from battery, $I = \frac{E}{R_{AB}} = \frac{4}{2} = 2 \text{ A}$

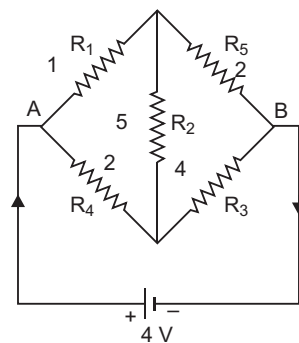

13. (a) The visible radiations and radiowaves can penetrate the earth's atmosphere but X-rays are absorbed by the atmosphere.
(b) The ozone layer absorbs ultraviolet and other low wavelength radiations which are harmful to living cells of human bodies and plants; hence ozone layer is crucial for human survival.
14. **Current sensitivity :** It is defined as the deflection of coil per unit current flowing in it.

Current Sensitivity, $S_\theta = \frac{\theta}{I} = \frac{NAB}{C}$

Voltage sensitivity : It is defined on the deflection of coil per unit potential difference across its ends.

$$\text{Voltage Sensitivity, } S_V = \frac{\theta}{V} = \frac{NAB}{GC}$$

where G is resistance of galvanometer.

Justification: When number of turns N is doubled, then the current sensitivity ($\propto N$) is doubled; but at the same time, the resistance of galvanometer coil (G) will also be doubled, so voltage sensitivity ($S_V \propto \frac{N}{G}$) will remain unchanged; hence increasing current sensitivity does not necessarily increase the voltage sensitivity.

15. **Linearly Polarised Light:** The light having vibrations of electric field vector in only one direction perpendicular to the direction of propagation of light is called plane (or linearly) polarised light.

The unpolarised and polarised light is represented as

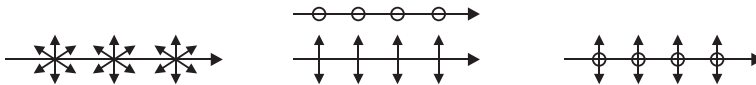

- (a) Unpolarised light (b) Polarised light (c) Partially polarised light

Intensity of transmitted light is maximum when the polaroid sheet makes an angle of 45° with the pass axis.

This is maximum when $\sin 2\theta = 1$ or $\theta = 45^\circ$.

16. When length of a given wire is made n -times by stretching it, its resistance becomes n^2 times i.e., $R' = n^2 R = (2)^2 \times 15 = 60 \Omega$

$$\text{Resistance of each half part} = \frac{60}{2} = 30 \Omega$$

$$\text{When both parts are connected in parallel, final resistance} = \frac{30}{2} = 15 \Omega$$

Current drawn from battery,

$$\begin{aligned} I &= \frac{V}{R} \\ &= \frac{3 \cdot 0}{15} = 0 \cdot 2 \text{ A} \end{aligned}$$

17. (a) The mass of a nucleons in ground state is always less than the total mass of its constituents neutrons and protons; because this mass difference appears in the form of binding energy to hold the nucleons inside the nucleus.

(b) Part AB represents repulsive force and part BCD represents attractive force.

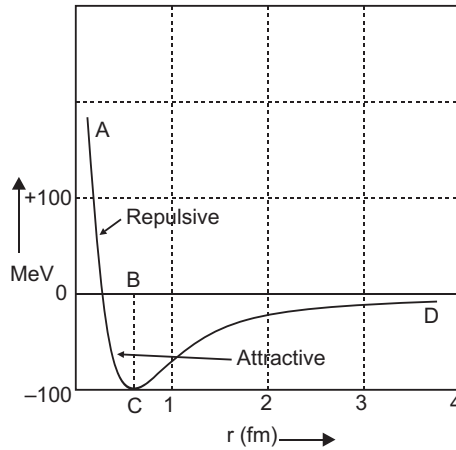

18. (i) **Transducer:** A device which convert one form of energy into the other.
 (ii) **Repeater:** A repeater picks up the signal from the transmitter, amplifies and retransmits it to the receiver sometimes with a change in a carrier frequency.

OR

Need of Modulation: Modulation is needed for (i) Practicable size of antenna. (ii) More effective power radiation by an antenna.

19. The electric field lines are shown in fig.

Electric field on the Surface of a Charged Conductor:

Let electric charge be uniformly distributed over the surface of a thin, non-conducting infinite sheet. Let the surface charge density (*i.e.*, charge per unit surface area) be σ . We have to calculate the electric field strength at any point distance r from the sheet of charge.

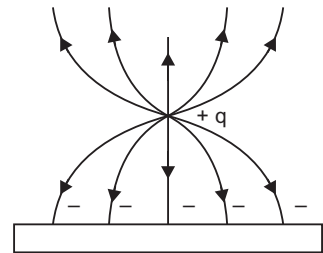

To calculate the electric field strength near the sheet, we now consider a cylindrical Gaussian surface bounded by two plane faces A and B lying on the opposite sides and parallel to the charged sheet and the cylindrical surface perpendicular to the sheet (fig). By symmetry the electric field strength at every point on the flat surface is the same and its direction is normal outwards at the points on the two plane surfaces and parallel to the curved surface.

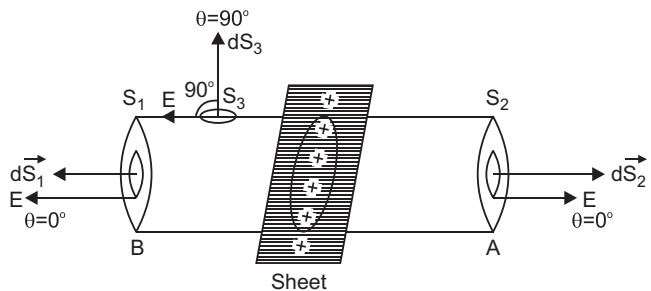

Total electric flux

$$\oint_S \vec{E} \cdot d\vec{S} = \oint_{S_1} \vec{E} \cdot d\vec{S}_1 + \oint_{S_2} \vec{E} \cdot d\vec{S}_2 + \oint_{S_3} \vec{E} \cdot d\vec{S}_3$$

$$\begin{aligned} \text{or } \oint_S \vec{E} \cdot d\vec{S} &= \int_{S_1} E dS_1 \cos 0^\circ + \int_{S_2} E dS_2 \cos 0^\circ + \int_{S_3} E dS_3 \cos 90^\circ \\ &= E \int dS_1 + E \int dS_2 = E a + E a = 2E a \end{aligned}$$

\therefore Total electric flux = $2E a$.

As σ is charge per unit area of sheet and a is the intersecting area, the charge enclosed by Gaussian surface = σa

According to Gauss's theorem,

$$\text{Total electric flux} = \frac{1}{\epsilon_0} \times (\text{total charge enclosed by the surface})$$

$$\text{i.e., } 2Ea = \frac{1}{\epsilon_0} (\sigma a)$$

$$\therefore E = \frac{\sigma}{2\epsilon_0}.$$

Thus electric field strength due to an infinite flat sheet of charge is independent of the distance of the point and is directed normally away from the charge. If the surface charge density σ is negative the electric field is directed towards the surface charge.

OR

(i) The capacitance of capacitor increases to K times (since $C = \frac{K \epsilon_0 A}{d} \propto K$)

(ii) The potential difference between the plates becomes $\frac{1}{K}$ times.

Reason: $V = \frac{Q}{C}$; Q same, C increases to K times

$$\therefore V' = \frac{V}{K}$$

As $E = \frac{V}{d}$ and V is decreased; therefore, electric field decreases to $\frac{1}{K}$ times.

(iii) Energy stored by the capacitor, $U = \frac{Q^2}{2C}$.

As $Q = \text{constant}$, C is increased, and so energy stored by capacitor decreases to $\frac{1}{K}$ times.

20. (i) Metre Bridge: Meter bridge is based on the principle of Wheatstone's bridge.

The resistance of wire is divided into two resistances P and Q . R is known resistance and S is unknown resistance.

$$\text{At balance } \frac{P}{Q} = \frac{R}{S} \Rightarrow \frac{l\rho}{(100-l)\rho} = \frac{R}{S}$$

$$\Rightarrow \text{unknown resistance, } S = \left(\frac{100 - l}{l} \right) R$$

(ii) In first case

$$\frac{R}{S} = \frac{l_1}{100 - l_1} \quad \dots(1)$$

When X and S are in parallel, let resistance

$$S' = \frac{XS}{X + S}$$

In second case

$$\frac{R}{\left(\frac{XS}{X + S} \right)} = \frac{l_2}{100 - l_2} \quad \dots(2)$$

Dividing (2) by (1), we get

$$\frac{X + S}{X} = \frac{l_1}{l_2} \left(\frac{100 - l_1}{100 - l_2} \right)$$

$$\Rightarrow X = \frac{S}{\frac{l_2}{l_1} \left(\frac{100 - l_1}{100 - l_2} \right) - 1}$$

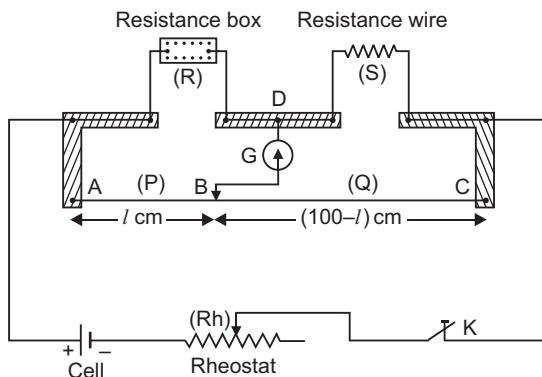

21. (i) **Faraday's Laws of Electromagnetic Induction:**

(a) Whenever there is a change in magnetic flux linked with of a coil, an emf is induced in the coil. The induced emf is proportional to the rate of change of magnetic flux linked with the coil.

$$\text{i.e., } e \propto \frac{\Delta\phi}{\Delta t}$$

(b) emf induced in the coil opposes the change in flux, i.e.,

$$e \propto - \frac{\Delta\phi}{\Delta t} \Rightarrow e = -k \frac{\Delta\phi}{\Delta t}$$

where k is a constant of proportionality.

In S.I. system ϕ is in weber, t in second, e in volt, then $k = 1$, so $e = - \frac{\Delta\phi}{\Delta t}$

If the coil contains N -turns, then $e = -N \frac{\Delta\phi}{\Delta t}$

(ii) The wing of horizontal travelling plane will cut the vertical component of earth's magnetic field, so emf is induced across the wing. The vertical component of earth's field is given by

$$V = B_e \sin \theta;$$

where B_e is earth's magnetic field and θ is angle of dip

Induced emf of wing $\varepsilon = V v l = (B_e \sin \theta) v l$

Given $B_e = 5.0 \times 10^{-4} \text{ T}$, $l = 25 \text{ m}$, $\theta = 30^\circ$,

$$v = 1800 \text{ km/h} = 1800 \times \frac{5}{18} \text{ m/s} = 500 \text{ m/s}$$

$$\begin{aligned} \therefore \varepsilon &= (5.0 \times 10^{-4} \times \sin 30^\circ) \times 500 \times 25 \\ &= (5.0 \times 10^{-4} \times 0.5) \times 500 \times 25 = 3.1 \text{ V} \end{aligned}$$

$$22. \quad \beta_1 = \frac{\lambda_1 D}{d} \quad \dots(1)$$

$$\beta_2 = \frac{\lambda_2 D}{d} \quad \dots(2)$$

$$\therefore \frac{\beta_2}{\beta_1} = \frac{\lambda_2}{\lambda_1}$$

$$\Rightarrow \lambda_2 = \frac{\beta_2}{\beta_1} \lambda_1$$

Given $\beta_1 = 8.1 \text{ mm}$, $\beta_2 = 7.2 \text{ mm}$, $\lambda_1 = 630 \text{ nm}$

$$\begin{aligned} \therefore \lambda_2 &= \left(\frac{7.2 \text{ mm}}{8.1 \text{ mm}} \right) \times 630 \text{ nm} \\ &= 560 \text{ nm} \end{aligned}$$

Use of white light: When white light is used to illuminate the slit, we obtain an interference pattern consisting of a central white fringe having on both sides symmetrically a few coloured fringes and then uniform illumination.

23. **The Schematic arrangement of Geiger-Marsdon Experiment** (also known as Rutherford Scattering Experiment) is shown in fig.

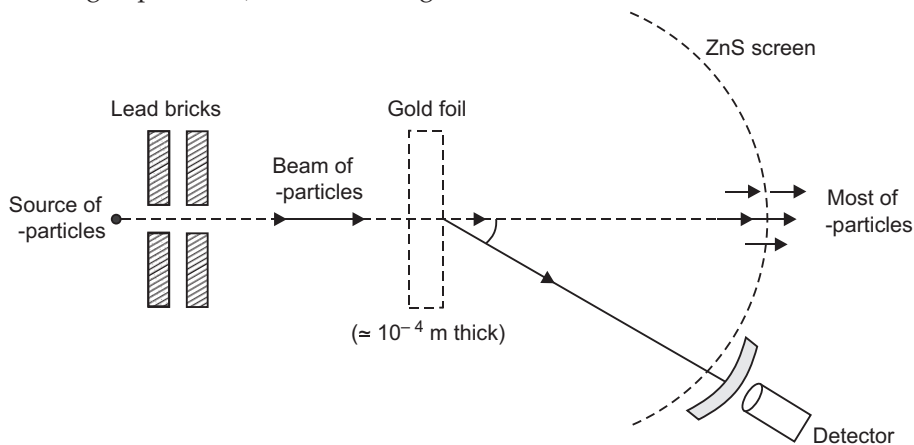

Observations: (i) Only a small fraction of number of α -particles rebound back. This shows that the number of α -particles undergoing head on collision is very small. The conclusion is that the entire positive charge of atom is concentrated in a small volume called the **nucleus**.

At the distance of head on approach, the entire kinetic energy of α -particle is converted into electrostatic potential energy. This distance of head on approach gives an upper limit of the size of nucleus (denoted by r_0) and is given by

$$E_k = \frac{1}{4\pi\epsilon_0} \frac{(Ze)(2e)}{r_0}$$

$$\Rightarrow r_0 = \frac{1}{4\pi\epsilon_0} \frac{2Ze^2}{E_k}$$

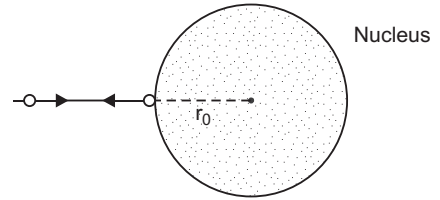

This is about 10^{-14} m.

24. Distinction between sky wave and Space wave Propagation:

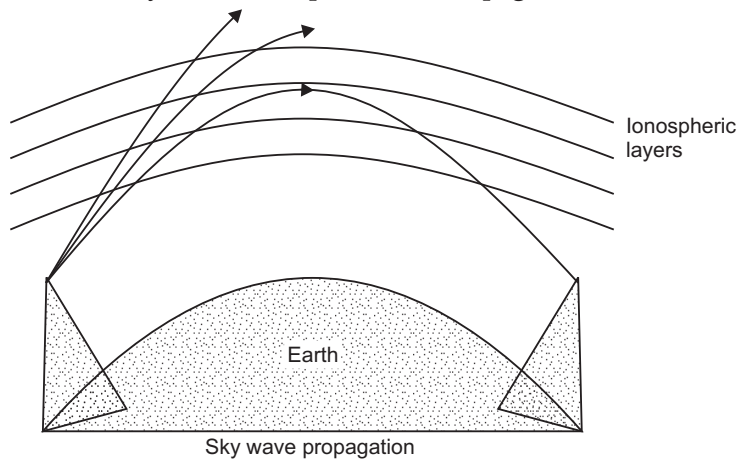

Sky wave propagation is achieved by ionospheric reflection of radiowaves, while space wave propagation is direct, line of sight propagation from the transmitted to the receiver.

Sky Wave Propagation: In sky wave propagation, the radiowaves transmitted from antenna get reflected from the ionosphere and thereby reach the receiving antenna.

Space Wave Propagation: In space wave propagation the radiowaves transmitted from antenna reach the receiving antenna through a **line of sight** (straight) propagation. The range of such a transmission is limited by the curvature of the earth.

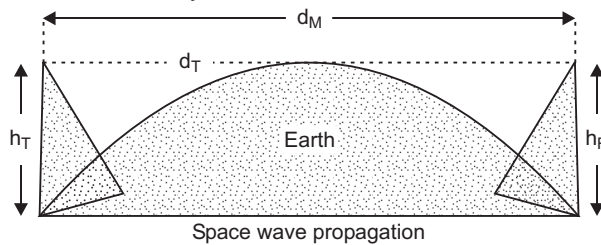

25. **Formation of Depletion Layer:** At the junction there is diffusion of charge carriers due to thermal agitation; so that some of electrons of n -region diffuse to p -region while some of holes of p -region diffuse into n -region. Some charge carriers combine with opposite charges to neutralise each other. Thus near the junction there is an excess of positively charged ions in n -region and an excess of negatively charged ions in p -region. This sets up a **potential difference** and hence an internal electric field E_i across the junctions. The field E_i is directed from n -region to p -region. This field stops the further diffusion of charge carriers. Thus the layers ($\approx 10^{-4}$ cm to 10^{-6} cm) on either side of the junction becomes free from mobile charge carriers and hence is called the *depletion layer*. The symbol of p - n junction diode is shown in Fig.

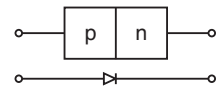
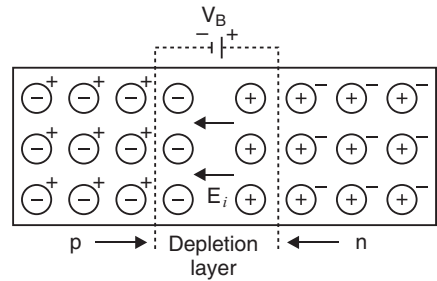

Effect of Forward and Reverse Bias:

(i) Under forward biasing the applied potential difference causes a field which acts opposite to the potential barrier. This results in reducing the potential barrier, and hence the width of depletion layer decreases.

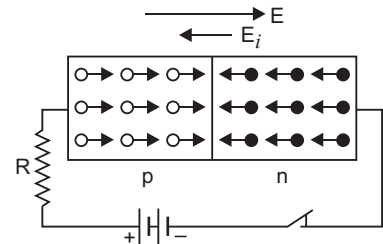

(b) Forward current

(ii) Under reverse biasing the applied potential difference causes a field which is in the same direction as the field due to internal potential barrier. This results in an increase in barrier voltage and hence the width of depletion layer increases.

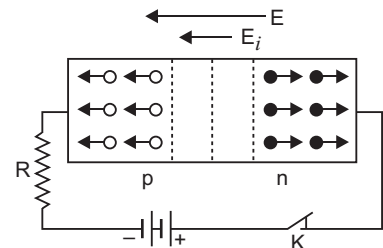

(c) Reverse current

26. **Common emitter amplifier using n - p - n transistor**

The circuit of common emitter amplifier using n - p - n transistor is shown below:

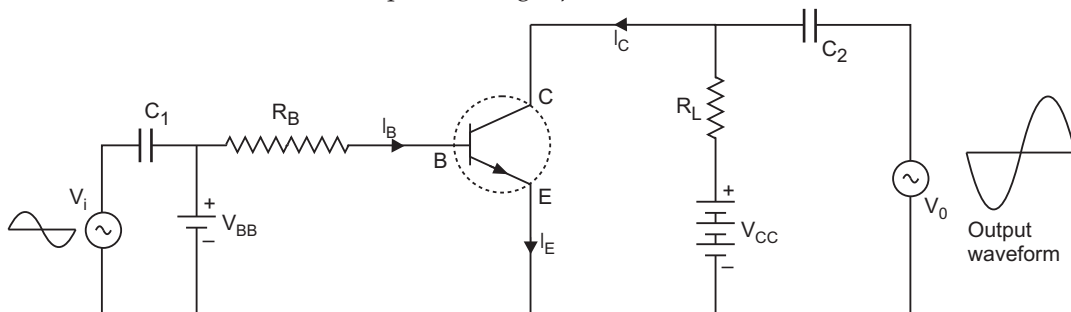

The phase difference between input signal and output voltage is 180° .

The input and output waveforms are shown in figure.

$$\text{Voltage gain } A_v = \beta \frac{R_L}{R_i}$$

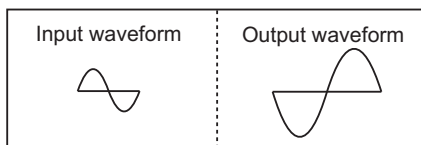

27. The variation of binding energy per nucleon versus mass number is shown in figure.

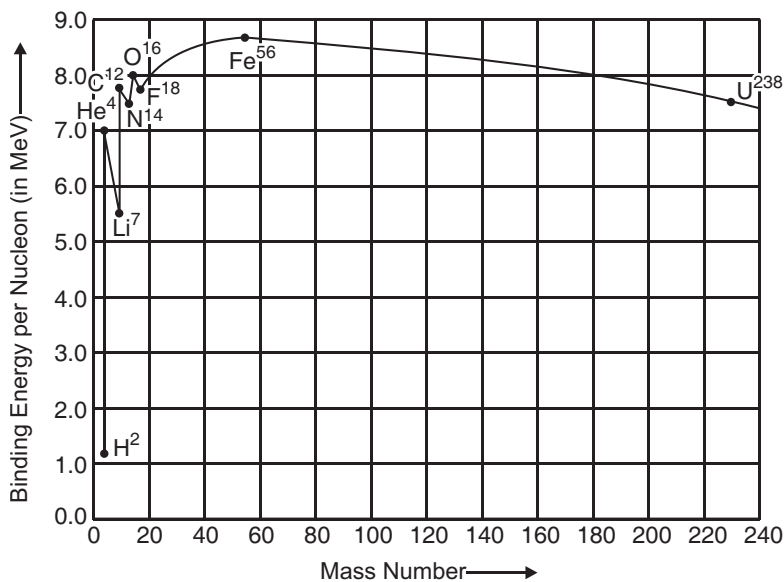

Inferences from graph

1. The nuclei having mass number below 20 and above 180 have relatively small binding energy and hence they are unstable.
2. The nuclei having mass number 56 and about 56 have maximum binding energy – 5.8 MeV and so they are most stable.
3. Some nuclei have peaks, e.g., ${}_2\text{He}^4$, ${}_6\text{C}^{12}$, ${}_8\text{O}^{16}$; this indicates that these nuclei are relatively more stable than their neighbours.

Explanation: When a heavy nucleus ($A \geq 235$ say) breaks into two lighter nuclei (nuclear fission), the binding energy per nucleon increases *i.e.* nucleons get more tightly bound. This implies that energy would be released in nuclear fission.

When two very light nuclei ($A \leq 10$) join to form a heavy nucleus, the binding is energy per nucleon of fused heavier nucleus more than the binding energy per nucleon of lighter nuclei, so again energy would be released in nuclear **fusion**.

28. Working: The principle of action of the apparatus is shown in fig. The positive ions produced from a source S at the centre are accelerated by a dee which is at negative potential at that moment. Due to the presence of perpendicular magnetic field the ion will move in a circular path inside the dees. The magnetic field and the frequency of the applied voltages are so chosen that as the ion comes out of a dee, the dees change their polarity (positive becoming negative and vice-versa) and the ion is further accelerated and moves with higher velocity along a circular path of greater radius. The phenomenon is continued till the ion reaches at the periphery of the dees where an auxiliary negative electrode (deflecting plate) deflects the accelerated ion on the target to be bombarded.

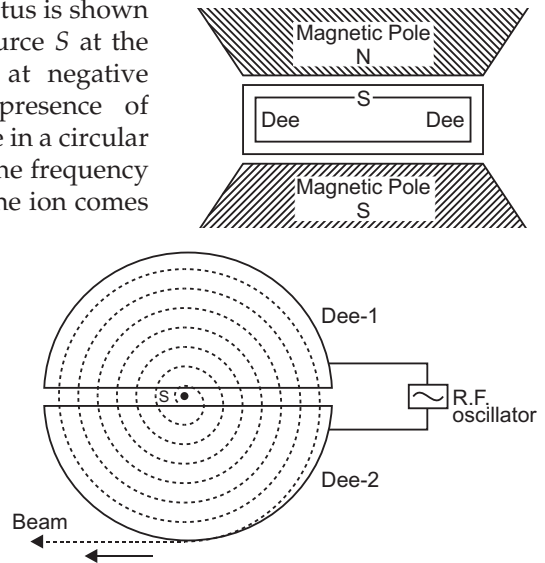

The **function of electric field** is to accelerate the charged particle and so to impart energy to the charged particle.

The function of magnetic field is to provide circular path to charged particle and so to provide the location where charged particle is capable of gaining energy from electric field.

(i) Expression for Period of Revolution

Suppose the positive ion with charge q moves in a dee with a velocity v , then,

$$qvB = \frac{mv^2}{r} \quad \text{or} \quad r = \frac{mv}{qB} \quad \dots(1)$$

where m is the mass and r the radius of the path of ion in the dee and B is the strength of the magnetic field.

The angular velocity ω of the ion is given by,

$$\omega = \frac{v}{r} = \frac{qB}{m} \quad (\text{from equation 1}) \quad \dots(2)$$

The time taken by the ion in describing a semi-circle, *i.e.*, in turning through an angle π is,

$$t = \frac{\pi}{\omega} = \frac{\pi m}{Bq} \quad \dots(3)$$

Thus the time is independent of the speed of the ion.

- (ii) Resonance Condition:** The condition of working of cyclotron is that the frequency of radio frequency alternating potential must be equal to the frequency of revolution of charged particles within the dees. This is called resonance condition.

Now for the cyclotron to work, the applied alternating potential should also have the same semi-periodic time ($T / 2$) as that taken by the ion to cross either dee, *i.e.*,

$$\frac{T}{2} = t = \frac{\pi m}{qB} \quad \dots(4)$$

or
$$T = \frac{2\pi m}{qB} \quad \dots(5)$$

This is the expression for period of revolution.

Obviously, period of revolution is independent of speed of charged particle and radius of circular path.

OR

- (a) Suppose two long thin straight conductors (or wires) PQ and RS are placed parallel to each other in vacuum (or air) carrying currents I_1 and I_2 respectively. It has been observed experimentally that when the currents in the wire are in the same direction, they experience an attractive force (fig. a) and when they carry currents in opposite directions, they experience a repulsive force (fig. b).

Let the conductors PQ and RS carry currents I_1 and I_2 in same direction and placed at separation r . (fig.).

Consider a current-element ' ab ' of length ΔL of wire RS . The magnetic field produced by current-carrying conductor PQ at the location of other wire RS

$$B_1 = \frac{\mu_0 I_1}{2\pi r} \quad \dots(1)$$

According to Maxwell's right hand rule or right hand palm rule no. 1, the direction of B_1 will be perpendicular to the plane of paper and directed downward. Due to this magnetic field, each element of other wire experiences a force. The direction of current element is perpendicular to the magnetic field; therefore the magnetic force on element ab of length ΔL

$$\Delta F = B_1 I_2 \Delta L \sin 90^\circ = \frac{\mu_0 I_1}{2\pi r} I_2 \Delta L$$

\therefore The total force on conductor of length L will be

$$F = \frac{\mu_0 I_1 I_2}{2\pi r} \sum \Delta L = \frac{\mu_0 I_1 I_2}{2\pi r} L$$

\therefore Force acting on per unit length of conductor

$$f = \frac{F}{L} = \frac{\mu_0 I_1 I_2}{2\pi r} \text{ N/m} \quad \dots(2)$$

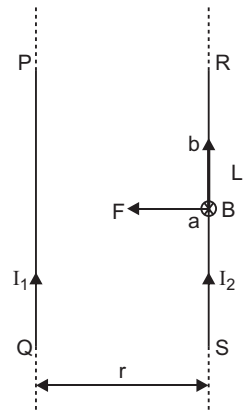

According to Fleming's left hand rule, the direction of magnetic force will be towards PQ i.e. the force will be attractive.

- (i) The magnetic field lines due to two current carrying parallel wires are shown in figure.

The force between parallel wires $\frac{F}{l} = \frac{\mu_0 I_1 I_2}{2\pi r}$ N/m

- (ii) We know that parallel currents attract and opposite currents repel and $F \propto \frac{1}{r}$. As wire of loop carrying

opposite current is nearer, so the net force acting on the loop is **repulsive**.

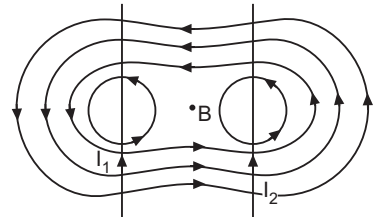

- (b) (i) Direction of magnetic moment m of the current loop is perpendicular to the plane of paper and directed downward.
 (ii) Torque acting on the current loop is (a) maximum when \vec{m} is perpendicular to \vec{B} .
 (b) Minimum when \vec{M} is parallel to \vec{B} .

29. (a) **Eddy currents:** When a metallic plate is placed in a time varying magnetic field, the magnetic flux linked with the plate changes, the induced currents are set up in the plate; these currents are called **eddy currents**. These currents are sometimes so strong, that the metallic plate becomes red hot.

Application of Eddy Currents:

- 1. Induction Furnace:** In induction furnace, the metal to be heated is placed in a rapidly varying magnetic field produced by high frequency alternating current. Strong eddy currents are set up in the metal produce so much heat that the metal melts. This process is used in extracting a metal from its ore. The arrangement of heating the metal by means of strong induced currents is called the induction furnace.
- 2. Induction Motor :** The eddy currents may be used to rotate the rotor. Its principle is : When a metallic cylinder (or rotor) is placed in a rotating magnetic field, eddy currents are produced in it. According to Lenz's law, these currents tend to reduce to relative motion between the cylinder and the field. The cylinder, therefore, begins to rotate in the direction of the field. This is the principle of induction motion.

(b) (i) Induced emf $|\varepsilon| = \frac{d\phi}{dt} = \frac{d}{dt}(BA)$
 $= B \left(\frac{dA}{dt} \right) = B \frac{d}{dt}(lx)$
 $= Bl \frac{dx}{dt} = Blv$

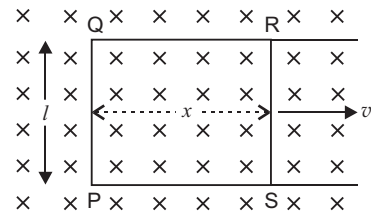

(ii) Force on arm $RS = BIl$
 $= B \left(\frac{\varepsilon}{R'} \right) \cdot l = B \left(\frac{Blv}{R'} \right) l = \frac{B^2 l^2 v}{R'}$

where $R' =$ resistance.

(iii) Power dissipated on heat
 $P = Fv = \frac{B^2 l^2 v}{R'} v = \frac{B^2 l^2 v^2}{R'}$

OR

(a) **Lenz's law:** According to this law *“the direction of induced current in a closed circuit is always such as to oppose the cause that produces it.”*

Example: When the north pole of a coil is brought near a closed coil, the direction of current induced in the coil is such as to oppose the approach of north pole. For this the nearer face of coil behaves as north pole. This necessitates an anticlockwise current in the coil, when seen from the magnet side [fig. (a)]

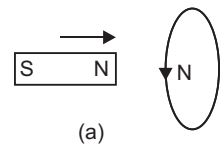

Similarly when north pole of the magnet is moved away from the coil, the direction of current in the coil will be such as to attract the magnet. For this the nearer face of coil behaves as south pole. This necessitates a clockwise current in the coil, when seen from the magnet side (fig. b).

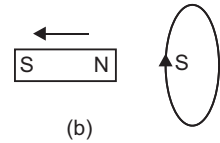

Conservation of Energy in Lenz's Law: Thus, in each case whenever there is a relative motion between a coil and the magnet, a force begins to act which opposes the relative motion. Therefore to maintain the relative motion, a mechanical work must be done. This work appears in the form of electric energy of coil. Thus *Lenz's law is based on conservation of energy.*

- (b) Suppose two co-axial solenoids S_1 and S_2 of radii r_1 and r_2 , number of turns N_1 and N_2 each of length ' l '

Suppose I_1 is the current in outer solenoid; magnetic field at the axis, $B_1 = \mu_0 n_1 I_1$ where $n_1 =$ number of turns/meter of outer solenoid.

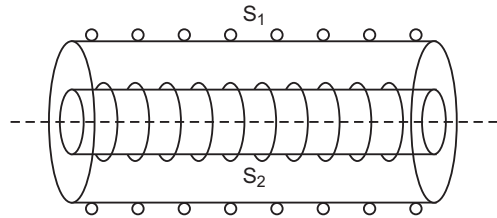

Magnetic flux linked with inner solenoid (S_2).

$$\begin{aligned} \phi_2 &= (N_2) B_1 A_1 = N_2 (\mu_0 n_1 I_1) \pi r_1^2 \\ &= \mu_0 n_1 N_2 \pi r_1^2 I_1 \end{aligned}$$

\therefore Mutual inductance of two solenoid system

$$M = \frac{\phi_2}{I_1} = \mu_0 n_1 N_2 \pi r_1^2$$

But $n_1 = \frac{N_1}{l} \quad \therefore M = \frac{\mu_0 N_1 N_2 \pi r_1^2}{l}$

30. (a) (i)

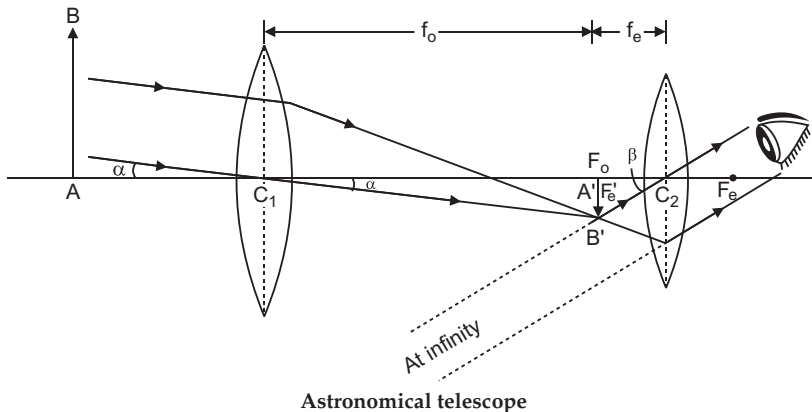

Astronomical telescope

(ii) Advantages of Reflecting Telescope over Refracting Telescope:

- | | |
|-------------------------------|-------------------------------|
| (a) Less chromatic aberration | (b) Less spherical aberration |
| (c) High resolving power | (d) High intense image |

(b) The position of image formed by convex lens is

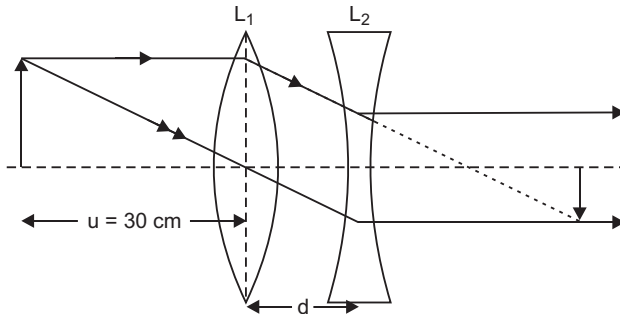

$$\frac{1}{f_1} = \frac{1}{v_1} - \frac{1}{u_1} \Rightarrow \frac{1}{v_1} = \frac{1}{f_1} + \frac{1}{u_1} = \frac{1}{10} - \frac{1}{30} \Rightarrow v_1 = 15 \text{ cm}$$

For concave lens $u_2 = 15 - 5 = +10 \text{ cm}$, $f_2 = -10 \text{ cm}$

$$\therefore \frac{1}{f_2} = \frac{1}{v_2} - \frac{1}{u_2} \Rightarrow \frac{1}{v_2} = \frac{1}{f_2} + \frac{1}{u_2} = -\frac{1}{10} + \frac{1}{10} \Rightarrow v_2 = \infty$$

That is final image is formed at infinity.

OR

(a) **Mirror Formula:** M_1M_2 is a concave mirror having pole P , focus F and centre of curvature C .

An object AB is placed in front of mirror with point B on the principal axis. The image formed by mirror is $A'B'$. The perpendicular dropped from point of incidence D on principal axis is DN .

In $\triangle ABC$ and $\triangle A'B'C$

$\angle ABC = \angle A'B'C$ (each equal to 90°)

$\angle ACB = \angle A'CB'$ (opposite angles)

Both triangles are similar.

$$\therefore \frac{AB}{A'B'} = \frac{BC}{B'C} \quad \dots(1)$$

Now in $\triangle DNF$ and $\triangle A'B'F$

$\angle DNF = \angle A'B'F$ (each equal to 90°)

$\angle DFN = \angle A'FB'$ (opposite angles)

\therefore Both triangles are similar

$$\frac{DN}{A'B'} = \frac{FN}{B'F} \text{ or } \frac{AB}{A'B'} = \frac{FN}{B'F} \quad (\because AB = DN) \quad \dots(2)$$

Comparing (1) and (2), we get

$$\frac{BC}{B'C} = \frac{FN}{B'F} \quad \dots(3)$$

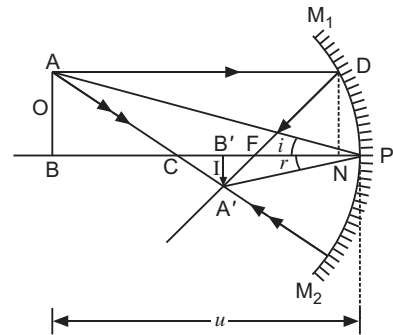

If aperture of mirror is very small, the point N will be very near to P , so $FN = FP$

$$\therefore \frac{BC}{B'C} = \frac{FP}{B'F} \quad \text{or} \quad \frac{PB - PC}{PC - PB'} = \frac{FP}{PB' - PF} \quad \dots(4)$$

By sign convention

Distance of object from mirror $PB = -u$

Distance of image from mirror $PB' = -v$

Focal length of mirror $PF = -f$

Radius of curvature of mirror $PC = -R = -2f$

Substituting these values in (4), we get

$$\frac{-u - (-2f)}{-2f - (-v)} = \frac{-f}{-v - (-f)} \quad \Rightarrow \quad \frac{-u + 2f}{-2f + v} = \frac{-f}{-v + f}$$

$$\Rightarrow \quad 2f^2 - vf = -uf + uv + 2f^2 - 2fv \quad \text{or} \quad fv + uf = uv$$

Dividing both sides by uvf , we get

$$\frac{1}{u} + \frac{1}{v} = \frac{1}{f}$$

The corresponding formula for thin lens is

$$\frac{1}{f} = \frac{1}{v} - \frac{1}{u}$$

$$(b) \quad \frac{1}{f} = \frac{1}{v} - \frac{1}{u}$$

The corrective lens must form the image of letters of book placed at 25 cm (near point) of hypermetropic eye.

That is $u = -25 \text{ cm}, v = -50 \text{ cm}$

$$\therefore \frac{1}{f} = -\frac{1}{50} + \frac{1}{25}$$

$$\Rightarrow \quad f = 50 \text{ cm} = 0.50 \text{ m}$$

$$\text{Power, } P = \frac{1}{f} = \frac{1}{0.50} \text{ D} = 2 \text{ D}$$

CBSE (All India) SET-II

1. At every point on equatorial axis, the potential is zero, so work done $W = q \Delta V = 0$ (zero).

5. Net power, $P = P_1 + P_2 = +4 \text{ D} - 2 \text{ D} = +2 \text{ D}$

$$\therefore \quad F = \frac{1}{P} = \frac{1}{2} = 0.50 \text{ m} = 50 \text{ cm}$$

6. Logic symbol of **NAND gate**.



7. Nuclear radius $R = R_0 A^{1/3}$

$$\therefore \frac{R_1}{R_2} = \left(\frac{A_1}{A_2} \right)^{1/3} = \left(\frac{8}{125} \right)^{1/3} = \frac{2}{5}$$

8. $(E_k)_{\max} = eV_s$

Stopping potential, $V_s = \frac{(E_k)_{\max}}{e} = \frac{3 \text{ eV}}{e} = 3 \text{ V}$

9. (i) The working of optical fiber is based on total internal reflection.

Statement: When a light ray goes from denser to rarer medium at an angle greater than critical angle, the ray is totally reflected in first (denser) medium.

This phenomenon is called total internal reflection.

(ii) Conditions:

(a) Ray of light must go from denser medium to rarer medium.

(b) Angle of incidence must be greater than critical angle (*i.e.*, $i > C$).

21. (i) **Lenz's Law:** The polarity of induced emf is such that it tends to produce a current which opposes the change in magnetic flux that produces it.

(ii) Capacitive reactance, $X_C = \frac{1}{2\pi fC}$

$$= \frac{1}{2 \times 3.14 \times 50 \times 15 \times 10^{-6}} \Omega = 212.1 \Omega$$

$$\begin{aligned} \text{RMS Current, } I &= \frac{E}{X_C} \\ &= \frac{220}{212.1} = 1.03 \text{ A} \end{aligned}$$

22. (a) (i) For n th minima, $d \sin \theta = n\lambda$

Given $\lambda = 650 \text{ nm} = 650 \times 10^{-9} \text{ m}$, $n = 1$, $\theta = 30^\circ$

$$\begin{aligned} \therefore d &= \frac{n\lambda}{\sin \theta} = \frac{1 \times 650 \times 10^{-9}}{\sin 30^\circ} = \frac{650 \times 10^{-9}}{0.5} \\ &= 1300 \times 10^{-9} \text{ m} = 1.3 \times 10^{-6} \text{ m} \\ &= 1.3 \mu\text{m} \end{aligned}$$

(ii) For n th maxima, $d \sin \theta = (2n + 1) \frac{\lambda}{2}$

$n = 1$, $\theta = 30^\circ$, $\lambda = 650 \times 10^{-9} \text{ m}$

$$\therefore d = \frac{(2n+1)\lambda}{2 \sin \theta} = \frac{3 \times 650 \times 10^{-9}}{2 \times 0.5} = 1.95 \times 10^{-6} \text{ m} = 1.95 \mu\text{m}$$

(b) To produce secondary maxima, the wavelets from lesser and lesser part of slit produce constructive interference.

23. Let electric charge be uniformly distributed over the surface of a thin, non-conducting infinite sheet. Let the surface charge density (*i.e.*, charge per unit surface area) be σ . We have to calculate the electric field strength at any point distance r from the sheet of charge.

To calculate the electric field strength near the sheet, we now consider a cylindrical Gaussian surface bounded by two plane faces A and B lying on the opposite sides and parallel to the charged sheet and the cylindrical surface perpendicular to the sheet (fig). By symmetry the electric field strength at every point on the flat surface is the same and its direction is normal outwards at the points on the two plane surfaces and parallel to the curved surface.

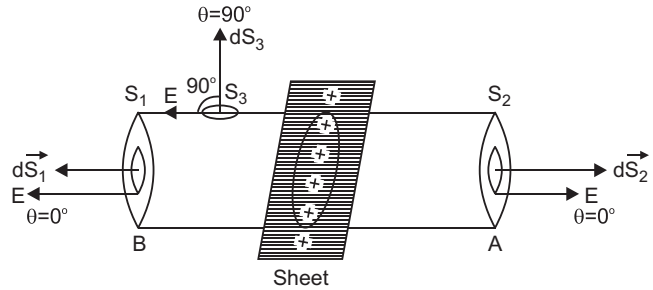

Total electric flux

$$\oint_S \vec{E} \cdot d\vec{S} = \oint_{S_1} \vec{E} \cdot d\vec{S}_1 + \oint_{S_2} \vec{E} \cdot d\vec{S}_2 + \oint_{S_3} \vec{E} \cdot d\vec{S}_3$$

$$\begin{aligned} \text{or } \oint_S \vec{E} \cdot d\vec{S} &= \int_{S_1} E dS_1 \cos 0^\circ + \int_{S_2} E dS_2 \cos 0^\circ + \int_{S_3} E dS_3 \cos 90^\circ \\ &= E \int dS_1 + E \int dS_2 = Ea + Ea = 2Ea \end{aligned}$$

\therefore Total electric flux = $2Ea$.

As σ is charge per unit area of sheet and a is the intersecting area, the charge enclosed by Gaussian surface = σa

According to Gauss's theorem,

Total electric flux = $\frac{1}{\epsilon_0} \times$ (total charge enclosed by the surface)

$$\text{i.e., } 2Ea = \frac{1}{\epsilon_0} (\sigma a)$$

$$\therefore E = \frac{\sigma}{2\epsilon_0}$$

$$\vec{E}_1 = \frac{\sigma}{2\epsilon_0} \hat{i}, \quad \vec{E}_2 = \frac{\sigma}{2\epsilon_0} \hat{i}$$

$$\vec{E} = \vec{E}_1 + \vec{E}_2 = \frac{\sigma}{\epsilon_0} \hat{i}$$

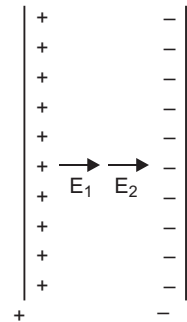

OR

(a) For **external points**, the charge may be supposed to be concentrated at the centre, so

$$V(R) = \frac{1}{4\pi\epsilon_0} \left(\frac{Q+q}{R} \right)$$

For internal points, the potential is same as on the surface

$$\therefore V(r) = \frac{1}{4\pi\epsilon_0} \left(\frac{q}{r} + \frac{Q}{R} \right)$$

$$\begin{aligned} \therefore \text{Potential difference, } V(r) - V(R) &= \frac{1}{4\pi\epsilon_0} \left[\frac{q}{r} + \frac{Q}{R} - \frac{Q+q}{R} \right] \\ &= \frac{1}{4\pi\epsilon_0} q \left[\frac{1}{r} - \frac{1}{R} \right] \end{aligned}$$

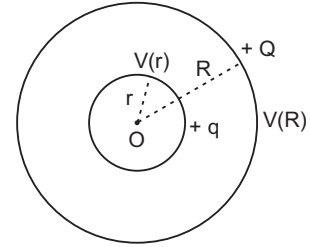

(b) When both shells are connected by a conducting wire, whole charge of inner shell will flow to outer shell.

Device Working on this principle is Van de Graaff Generator.

25. (i) **Forward Bias:** In this arrangement the positive terminal of battery is connected to *p*-end and negative terminal to *n*-end of the crystal, so that an external electric field *E* is established directed from *p* to *n*-end to oppose the internal field *E_i* as shown in Fig. The external field *E* is much stronger than internal field *E_i*.

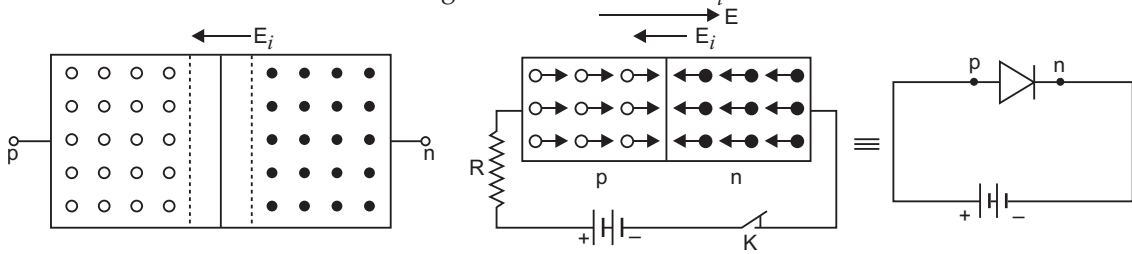

(a) No current

(b) Forward current

Reverse Bias: In this arrangement the positive terminal of battery is connected to *n*-end and negative terminal to *p*-end of the crystal, so that the external field is established to help the internal field *E_i* as shown in Fig. Under the biasing the holes in *p*-region and the electrons in *n*-region are pushed away from the junction to widen the depletion layer and hence increases the potential barrier, therefore the current flow stops.

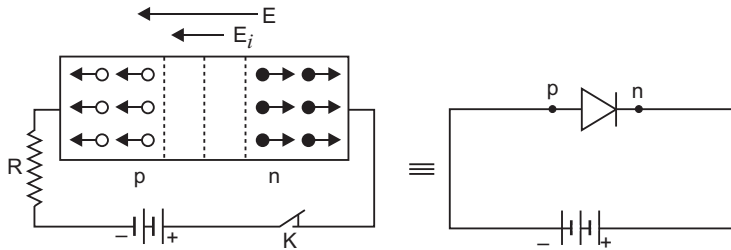

(c) Reverse current

Reverse biasing

(ii) V-I Characteristics of (a) forward bias and (b) reverse bias:

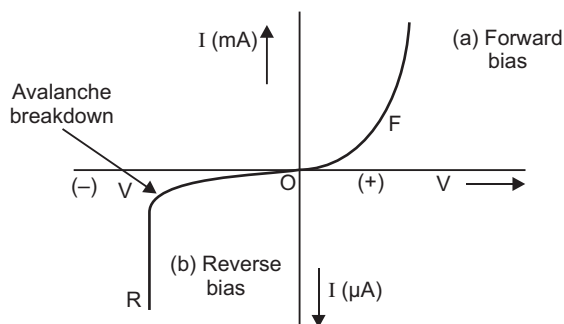

CBSE (All India) SET-III

- Potential energy of a charge q in an external electric field is defined as the work-done in bringing the charge q from infinity to a distance r in an external electric field produced by the other charge(s).
- Maximum kinetic energy, $(E_k)_{\max} = eV_s = e(2\text{ V}) = 2\text{ eV} = 2 \times 1.6 \times 10^{-19}\text{ J} = 3.2 \times 10^{-19}\text{ J}$
- Net power, $P = P_1 + P_2 = +5 - 2.5 = +2.5\text{ D}$
 \therefore Focal length, $F = \frac{1}{P} = \frac{1}{2.5}\text{ m} = 0.4\text{ m} = 40\text{ cm}$

- Symbol of AND gate.



$$8. \frac{R_1}{R_2} = \left(\frac{A_1}{A_2}\right)^{1/3} = \left(\frac{27}{125}\right)^{1/3} = \frac{3}{5}$$

- (i) Relation between refractive index (n) and critical angle (C) is

$$n = \frac{1}{\sin C}$$

(ii) Yes, critical angle depends on wavelength or colour of light; it increases with increase of wavelength being maximum for red and minimum for violet.

- Resistance of stretched wire $R' = n^2 R = (2)^2 \times 20 = 80\ \Omega$

When wire is cut into two equal parts, resistance of each part = $40\ \Omega$

When these parts are connected in parallel, net resistance $R_{\text{net}} = \frac{40 \times 40}{40 + 40} = 20\ \Omega$

$$\text{Current, } I = \frac{V}{R_{\text{net}}} = \frac{4.0}{20}\text{ A} = 0.2\text{ A}$$

$$\begin{aligned}
 22. \quad \beta &= \frac{D\lambda}{d} \\
 \therefore \quad \frac{\beta_1}{\beta_2} &= \frac{\lambda_1}{\lambda_2} \\
 \Rightarrow \quad \lambda_2 &= \frac{\beta_2}{\beta_1} \lambda_1 \\
 &= \frac{8 \text{ mm}}{10 \text{ mm}} \times 600 \text{ nm} = \mathbf{480 \text{ nm}}
 \end{aligned}$$

On replacing monochromatic light by white light; the interference pattern will contain central white fringe surrounded on either side by few coloured fringes.

25. Zener diode as a Voltage Regulator

The Zener diode makes its use as a voltage regulator due to the following property :

When a Zener diode is operated in the breakdown region, the voltage across it remains practically constant for a large change in the current.

A simple circuit of a voltage regulator using a Zener diode is shown in the figure. The Zener diode is connected across load such that it is reverse biased.

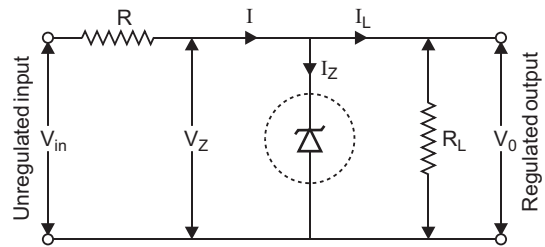

The series resistance R absorbs the output voltage fluctuations so as to maintain constant voltage across the load.

If the input dc voltage increases, the current through R and Zener diode also increases. So, voltage drop across R increases, without any change in the voltage across zener diode.

I-V Characteristics

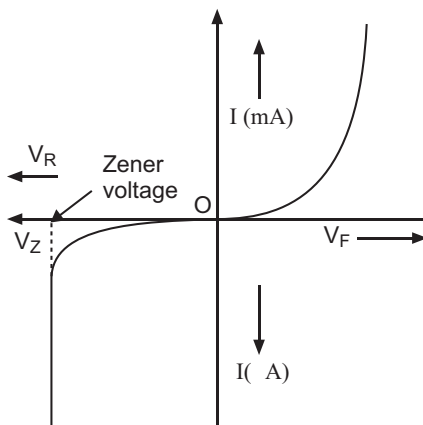

27. The activity of a radioactive element at any instant is equal to its rate of decay at that instant.

S.I. unit of activity is **becquerel**

(= 1 disintegration/second). The plot is shown in figure.

$$\text{Activity } R \left(= \frac{dN}{dt} \right) = \lambda N$$

$$\text{Decay constant } \lambda = \frac{\log_e 2}{T}$$

$$\therefore \text{Activity } R = \frac{(\log_e 2) N}{T}$$

$$\therefore R_1 = \frac{(\log_e 2) N_1}{T_1}, R_2 = \frac{(\log_e 2) N_2}{T_2}$$

$$\text{For two elements } \frac{R_1}{R_2} = \frac{N_1}{T_1} \times \frac{T_2}{N_2} = \left(\frac{N_1}{N_2} \right) \left(\frac{T_2}{T_1} \right)$$

$$\text{Numerical: } \frac{R}{R_0} = \left(\frac{1}{2} \right)^n$$

$$\text{Given } \frac{R}{R_0} = \frac{1}{8}, n = \frac{t}{T} = \frac{\text{Time taken}}{\text{Half life}}$$

$$\therefore \left(\frac{1}{8} \right) = \left(\frac{1}{2} \right)^n \Rightarrow \left(\frac{1}{2} \right)^3 = \left(\frac{1}{2} \right)^n \Rightarrow n = 3$$

$$\Rightarrow \frac{t}{T} = 3 \Rightarrow t = 3T \text{ years}$$

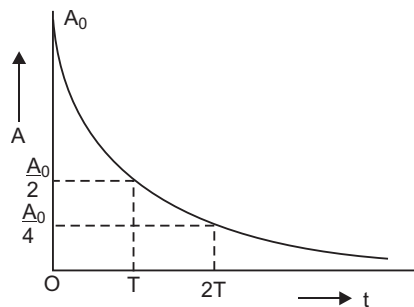

CBSE EXAMINATION PAPERS

FOREIGN-2009

Time allowed: 3 hours

Maximum marks: 70

General Instructions:

- All questions are compulsory.
- There are 30 questions in total. Questions 1 to 8 carry one mark each, questions 9 to 18 carry two marks each, questions 19 to 27 carry three marks each and questions 28 to 30 carry five marks each.
- There is no overall choice. However, an internal choice has been provided in one question of two marks, one question of three marks and all three questions of five marks each. You have to attempt only one of the given choices in such questions.
- Use of calculators is not permitted.
- You may use the following values of physical constants wherever necessary:

$$c = 3 \times 10^8 \text{ ms}^{-1}$$

$$h = 6.626 \times 10^{-34} \text{ Js}$$

$$e = 1.602 \times 10^{-19} \text{ C}$$

$$\mu_0 = 4\pi \times 10^{-7} \text{ TmA}^{-1}$$

$$\frac{1}{4\pi\epsilon_0} = 9 \times 10^9 \text{ Nm}^2\text{C}^{-2}$$

$$\text{Boltzmann's constant } k = 1.381 \times 10^{-23} \text{ J K}^{-1}$$

$$\text{Avogadro's number } N_A = 6.022 \times 10^{23} \text{ /mole}$$

$$\text{Mass of neutron } m_n = 1.2 \times 10^{-27} \text{ kg}$$

$$\text{Mass of electron } m_e = 9.1 \times 10^{-31} \text{ kg}$$

$$\text{Radius of earth} = 6400 \text{ km}$$

CBSE (Foreign) SET-I

- Why is it necessary that the field lines from a point charge placed in the vicinity of a conductor must be normal to the surface of the conductor at every point? 1
- A steady current flows in a metallic conductor of non-uniform cross-section. Which of these quantities is constant along the conductor:
Current, current density, drift speed, electric field? 1
- Name the electromagnetic radiations which are produced when high energy electrons are bombarded on a metal target. 1
- Draw the wavefront coming out of a convex lens when a point source of light is placed at its focus. 1
- Unpolarised light of intensity I is passed through a polaroid. What is the intensity of the light transmitted by the polaroid? 1
- Why are coherent sources required to create interference of light? 1

7. In the Rutherford scattering experiment the distance of closest approach for an α -particle is d_0 . If α -particle is replaced by a proton, how much kinetic energy in comparison to α -particle will it require to have the same distance of closest approach d_0 ? 1
8. State the Faraday's law of electromagnetic induction. 1
9. Figure shows a sheet of aluminium foil of negligible thickness placed between the plates of a capacitor. How will its capacitance be affected if: _____

- (i) the foil is electrically insulated? 2
- (ii) the foil is connected to the upper plate with a conducting wire? 2
10. Three points A, B and C lie in a uniform electric field (E) of $5 \times 10^3 \text{ NC}^{-1}$ as shown in the figure. Find the potential difference between A and C. 2

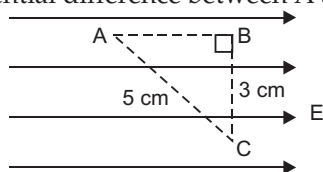

OR

The sum of two point charges is $7 \mu\text{C}$. They repel each other with a force of 1 N when kept 30 cm apart in free space. Calculate the value of each charge. 2

11. Name the electromagnetic radiations having the wavelength range from 1 mm to 700 nm. Give its two important applications. 2
12. A wire of length L is bent round in the form of a coil having N turns of same radius. If a steady current I flows through it in a clockwise direction, find the magnitude and direction of the magnetic field produced at its centre. 2
13. Derive an expression for the de-Broglie wavelength associated with an electron accelerated through a potential V . Draw a schematic diagram of a localised-wave describing the wave nature of the moving electron. 2
14. Figure shows variation of stopping potential (V_0) with the frequency (ν) for two photosensitive materials M_1 and M_2 .

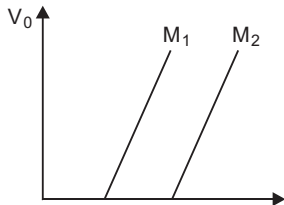

- (i) Why is the slope same for both lines?
- (ii) For which material will the emitted electrons have greater kinetic energy for the incident radiations of the same frequency? Justify your answer. 2
15. The energy of the electron in the ground state of hydrogen atom is -13.6 eV .
- (i) What does the negative sign signify?
- (ii) How much energy is required to take an electron in this atom from the ground state to the first excited state? 2

16. Draw the logic symbol of the gate whose **truth** table is given below:

Input		Output
A	B	Y
0	0	1
0	1	0
1	0	0
1	1	0

If this logic gate is connected to NOT gate, what will be output when (i) $A = 0, B = 0$ and (ii) $A = 1, B = 1$? Draw the logic symbol of the combination. **2**

17. (i) What is the line of sight communication? **2**
 (ii) Why is it not possible to use sky wave propagation for transmission of TV signals? **2**
18. (i) How are eddy currents reduced in a metallic core? **2**
 (ii) Give two uses of eddy currents. **2**
19. Define the term 'electric dipole moment.' Is it scalar or vector? **2**

Deduce an expression for the electric field at a point on the equatorial plane of an electric dipole of length $2a$. **3**

20. State Kirchoff's rules. Use Kirchoff's rules to show that no current flows in the given circuit.

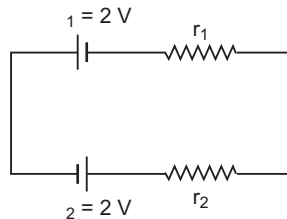

21. (a) State the Principle of working of a potentiometer. **3**
 (b) Figure shows the circuit diagram of a potentiometer for determining the emf ' ϵ ' of a cell of negligible internal resistance.
 (i) What is the purpose of using high resistance R_2 ?
 (ii) How does the position of balance point (J) change when the resistance R_1 is decreased?
 (iii) Why cannot the balance point be obtained (1) when the emf ϵ is greater than 2 V, and (2) when the key (K) is closed?

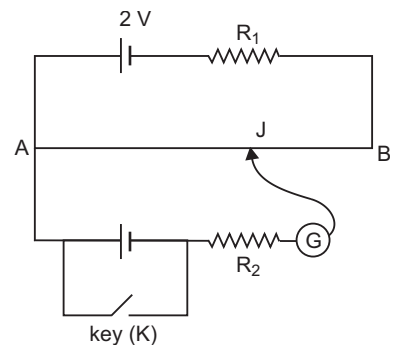

22. Deduce the expression for the torque experienced by a rectangular loop carrying a steady current ' I ' and placed in a uniform magnetic field \vec{B} . Indicate the direction of the torque acting on the loop. **3**

OR

Deduce the expression for magnetic dipole moment of an electron revolving around the nucleus in a circular orbit of radius ' r '. Indicate the direction of the magnetic dipole moment. **3**

23. Depict the field-line pattern due to a current carrying solenoid of finite length.
 (i) In what way do these lines differ from those due to an electric dipole?
 (ii) Why can't two magnetic field lines intersect each other? **3**
24. State the conditions under which total internal reflection occurs.
 One face of a prism with a refracting angle of 30° is coated with silver. A ray incident on another face at an angle of 45° is refracted and reflected from the silver coated face and retraces its path. Find the refractive index of the material of the prism. **3**
25. (a) Why do we not encounter diffraction effects of light in everyday observations?
 (b) In the observed diffraction pattern due to a single slit, how will the width of central maximum be affected if
 (i) the width of the slit is doubled;
 (ii) the wavelength of the light used is increased?
 Justify your answer in each case. **3**
26. (a) What is meant by half life of a radioactive element?
 (b) The half life of a radioactive substance is 30 s. Calculate
 (i) the decay constant, and
 (ii) time taken for the sample to decay by $3/4$ th of the initial value. **3**
27. What is meant by detection of a signal in a communication system? With the help of a block diagram explain the detection of AM signal. **3**
28. State the working principle of an AC generator with the help of a labelled diagram. Derive an expression for the instantaneous value of the emf induced in coil. Why is the emf maximum when the plane of the armature is parallel to the magnetic field? **5**

OR

Draw a labelled diagram of a step-up transformer and explain briefly its working.

Deduce the expressions for the secondary voltage and secondary current in terms of the number of turns of primary and secondary windings.

How is the power transmission and distribution over long distances done with the use of transformers? **5**

29. (a) Draw a ray diagram for formation of image of a point object by a thin double convex lens having radii of curvatures R_1 and R_2 and hence derive lens maker's formula.
 (b) Define power of a lens and give its S.I. units.
 If a convex lens of focal length 50 cm is placed in contact coaxially with a concave lens of focal length 20 cm, what is the power of the combination? **5**

OR

Draw a labelled ray diagram to show the image formation by an astronomical telescope.

Derive the expression for its magnifying power in normal adjustment. Write two basic features which can distinguish between a telescope and a compound microscope. **5**

30. (a) Explain the formation of 'depletion layer' and 'barrier potential' in a $p-n$ junction.
 (b) With the help of a labelled circuit diagram explain the use of a $p-n$ junction diode as a full wave rectifier. Draw the input and output waveforms. 5

OR

Draw a circuit diagram of an $n-p-n$ transistor with its emitter base junction forward biased and base collector junction reverse biased. Describe briefly its working.

Explain how a transistor in active state exhibits a low resistance at its emitter base junction and high resistance at its base collector junction.

Draw a circuit diagram and explain the operation of a transistor as a switch. 5

CBSE (Foreign) SET-II

Questions different from Set-I.

3. Define self-inductance. Give its S.I. units. 1
 7. Sketch the shape of wavefront emerging from a point source of light and also make the rays. 1
 11. A logic gate is obtained by applying output of OR gate to a NOT gate. Name the gate so formed. Write the symbol and truth table of this gate. 2
 12. A point charge is moving with a constant velocity perpendicular to a uniform magnetic field as shown in the figure. What should be the magnitude and direction of the electric field so that the particle moves undeviated along the same path? 2

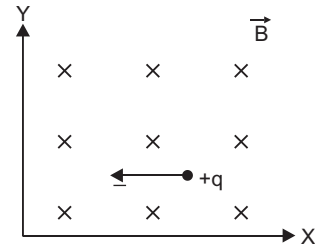

13. (a) Draw a graph showing variation of photo-electric current (I) with anode potential (V) for different intensities of incident radiation. Name the characteristic of the incident radiation that is kept constant in this experiment.
 (b) If the potential difference used to accelerate electrons is doubled, by what factor does the de-Broglie wavelength associated with the electrons change? 2
14. Three points A , B and C lie in a uniform electric field (E) of $5 \times 10^3 \text{ NC}^{-1}$ as shown in the figure. Find the potential difference between A and C . 2

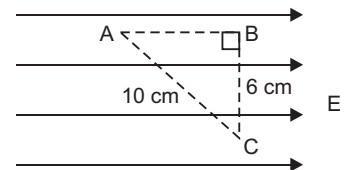

OR

The sum of two point charges is $9 \mu\text{C}$. They repel each other with a force of 2 N when kept 30 cm apart in free space. Calculate the value of each charge. 2

23. (i) What happens when a diamagnetic substance is placed in a varying magnetic field?
 (ii) Name the properties of a magnetic material that make it suitable for making (a) a permanent magnet and (b) a core of an electromagnet. 3
26. (a) Define the terms (i) 'amplitude modulation' and (ii) 'modulation index'.
 (b) If a low frequency signal in the audio frequency range is to be transmitted over long distances, explain briefly the need of translating this signal to high frequencies before transmission. 3
27. (a) What is meant by half life of a radioactive element?
 (b) The half life of a radioactive substance is 20 s. Calculate:
 (i) the decay constant and
 (ii) time taken for the sample to decay by $7/8^{\text{th}}$ of the initial value. 3

CBSE (Foreign) SET-III

Questions different from Set-I and Set-II.

1. A metal plate is introduced between the plates of a charged parallel plate capacitor. What is its effect on the capacitance of the capacitor? 1
4. Define mutual inductance. Give its S.I. units. 1
6. Name the electromagnetic radiation which can be produced by klystron or a magnetron valve. 1
8. Define a wavefront. 1
9. Figure shows two large metal plates P_1 and P_2 , tightly held against each other and placed between two equal and unlike point charges perpendicular to the line joining them.
 (i) What will happen to the plates when they are released?
 (ii) Draw the pattern of the electric field lines for the system. 2

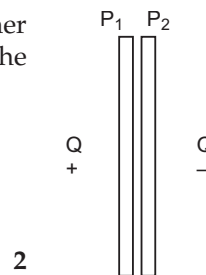

10. A 800 pF capacitor is charged by a 100 V battery. After some time the battery is disconnected. The capacitor is then connected to another 800 pF capacitor. What is the electrostatic energy stored? 2

OR

- The sum of two point charges is $7 \mu\text{C}$. They repel each other with a force of 1 N when kept 30 cm apart in free space. Calculate the value of each charge. 2
13. Name the electromagnetic radiations having the wavelength range from 1 nm to 10^{-3} nm. Give its two important applications. 2

14. A logic gate is obtained by applying output of AND gate to a NOT gate. Name the gate so formed. Write the symbol and truth table of this gate. **2**
16. The graph below shows variation of photo-electric current with collector plate potential for different frequencies of incident radiations.

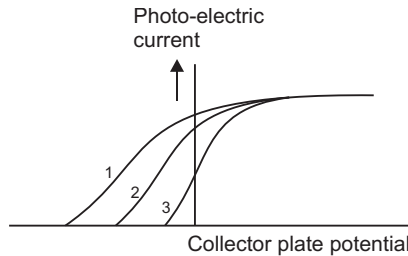

- (i) Which physical parameter is kept constant for the three curves?
 (ii) Which frequency (ν_1 , ν_2 or ν_3) is the highest? **2**
24. (i) How does angle of dip change as one goes from magnetic pole to magnetic equator of the Earth?
 (ii) A uniform magnetic field gets modified as shown below when two specimens X and Y are placed in it. Identify whether specimens X and Y are diamagnetic, paramagnetic or ferromagnetic.

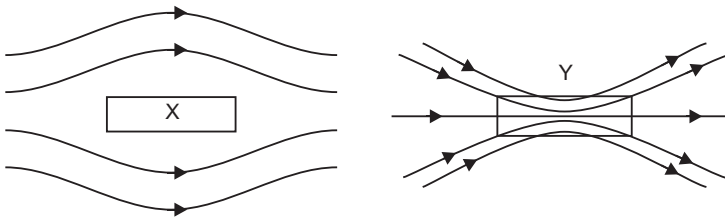

- (iii) How is the magnetic permeability of specimen X different from that of specimen Y? **3**
26. (a) What is meant by half life of a radioactive element?
 (b) The half life of a radioactive substance is 30 s. Calculate:
 (i) the decay constant, and
 (ii) time taken for the sample to decay by $3/4^{\text{th}}$ of the initial value. **3**

Solutions

CBSE (Foreign) SET-I

- Surface of a conductor is an equipotential surface and field lines are always directed from higher to lower potential, so field lines in the vicinity of a conductor must be normal to the surface of conductor.
- Current is constant along a conductor.
- X-rays.
- Wavefront is plane as shown in fig.

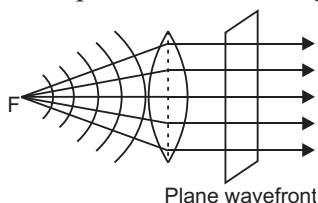

- Intensity of light transmitted through the polaroid = $\frac{I}{2}$.
- Coherent sources are required for **sustained interference**. If sources are incoherent, the intensity at a point will go on changing with time.

$$7. E_k = \frac{1}{4\pi\epsilon_0} \frac{(Ze)(2e)}{d_0} \quad (\text{for } \alpha\text{-particle, } q = 2e)$$

$$E'_k = \frac{1}{4\pi\epsilon_0} \frac{(Ze)(e)}{d_0} \quad (\text{for proton, } q = e)$$

$$\frac{E'_k}{E_k} = \frac{1}{2} \quad \Rightarrow \quad E'_k = \frac{E_k}{2}$$

That is KE of proton must be half on comparison with KE of α -particle.

- The magnitude of the induced emf in a circuit is equal to the time rate of change of magnetic flux through the circuit.

Mathematically, the induced emf is given by

$$e = - \frac{\Delta\phi}{\Delta t}$$

- No effect on capacitance if foil is electrically neutral.
 - If foil is connected to upper plate with a conducting wire, the effective separation between plates becomes half, so capacitance is doubled.
- The line joining B to C is perpendicular to electric field, so potential of B = potential of C i.e., $V_B = V_C$.
Distance $AB = 4 \text{ cm}$

$$\begin{aligned} \text{Potential difference between } A \text{ and } C &= E \times (AB) \\ &= 5 \times 10^3 \times (4 \times 10^{-2}) \\ &= \mathbf{200 \text{ volt}} \end{aligned}$$

OR

$$q_1 + q_2 = 7 \times 10^{-6} \text{ C} \quad \dots (1)$$

$$\frac{1}{4\pi\epsilon_0} \frac{q_1 q_2}{(0.30)^2} = 1 \quad \Rightarrow \quad q_1 q_2 = (4\pi\epsilon_0) (0.30)^2$$

$$\text{or} \quad q_1 q_2 = \frac{1}{9 \times 10^9} \times 9 \times 10^{-2} = 10^{-11} \quad \dots (2)$$

$$\begin{aligned} (q_1 - q_2)^2 &= (q_1 + q_2)^2 - 4q_1 q_2 \\ &= (7 \times 10^{-6})^2 - 4 \times 10^{-11} \\ &= 49 \times 10^{-12} - 40 \times 10^{-12} = 9 \times 10^{-12} \\ q_1 - q_2 &= 3 \times 10^{-6} \text{ C} \quad \dots (3) \end{aligned}$$

Solving (1) and (3), we get

$$\begin{aligned} q_1 &= 5 \times 10^{-6} \text{ C}, \quad q_2 = 2 \times 10^{-6} \text{ C} \\ \Rightarrow \quad q_1 &= 5 \mu\text{C}, \quad q_2 = 2 \mu\text{C} \end{aligned}$$

11. Infrared radiations

Applications: (i) Taking photograph during fog and smoke etc.
(ii) for therapeutic purposes.

$$12. \quad L = N \times 2\pi r \Rightarrow \quad r = \frac{L}{2\pi N}$$

$$B = \frac{\mu_0 NI}{2r} = \frac{\mu_0 NI}{2(L / 2\pi N)} \quad \Rightarrow \quad B = \frac{\mu_0 \pi N^2}{L} I$$

The direction of magnetic field is normal to plane of coil in downward direction.

13. Expression for de Broglie Wavelength associated with Accelerated ElectronsThe de Broglie wavelength associated with electrons of momentum p is given by

$$\lambda = \frac{h}{p} = \frac{h}{mv} \quad \dots (i)$$

where m is mass and v is velocity of electron. If E_K is the kinetic energy of electron, then

$$E_K = \frac{1}{2} mv^2 = \frac{1}{2} m \left(\frac{p}{m} \right)^2 = \frac{p^2}{2m} \quad \left(\text{since } p = mv \Rightarrow v = \frac{p}{m} \right)$$

$$\Rightarrow \quad p = \sqrt{2mE_K}$$

$$\therefore \text{ Equation (i) gives } \lambda = \frac{h}{\sqrt{2mE_K}} \quad \dots (ii)$$

If V volt is accelerating potential of electron, then Kinetic energy,

$$E_K = eV$$

∴ Equation (ii) gives

$$\lambda = \frac{h}{\sqrt{2meV}} \quad \dots(iii)$$

This is the required expression for de Broglie wavelength associated with electron accelerated to potential of V volt.

The diagram of wave packet describing the motion of a moving electron is shown.

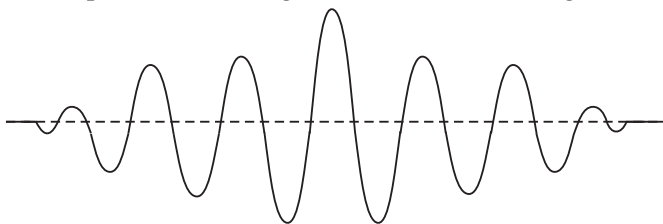

14. (i) The slope of stopping potential (V_0) versus frequency (ν) is equal to $\left(\frac{h}{e}\right)$ which is universal constant, so slope is same for both lines.

(ii) $K.E. = h\nu - h\nu_0$

As threshold frequency ν_0 is lesser for M_1 , so K.E. will be greater for M_1 for same frequency ν .

15. (i) Negative sign shows that electron in ground state is **bound** in H-atom due to attractive force between electron and nucleus.

(ii) Energy of electron in H-atom in n th orbit is

$$E_n = -\frac{Rhc}{n^2} = -\frac{13 \cdot 6}{n^2}$$

For first excited state $n = 2$

$$E_2 = -\frac{13 \cdot 6}{4} \text{ eV} = -3 \cdot 4 \text{ eV}$$

Energy required to take electron from ground state to first excited state

$$\begin{aligned} \Delta E &= E_2 - E_1 \\ &= -13 \cdot 6 \text{ eV} - (-3 \cdot 4 \text{ eV}) \\ &= 10 \cdot 2 \text{ eV} \end{aligned}$$

16. The given truth table is of **NOR** gate. The logic symbol is shown in fig.



When it is connected to a NOT gate, the gate becomes OR gate.

(i) $A = 0, B = 0$ gives output **0**.

(ii) $A = 1, B = 1$ gives output **1**.

The combination is shown in fig.

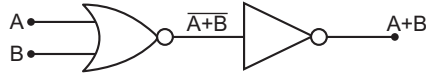

17. (a) **LOS Communication:** The propagation of a radio wave in a straight line from transmitting to receiving antenna on the ground is called line of sight communication.
- (b) TV signals have high frequency range 100 to 200 MHz. Ionospheric layers do not reflect back such high frequency signals. Hence, sky waves cannot be used for transmission of TV signals.
18. (i) A metallic core cuts the path of eddy currents, this reducing the strength of eddy currents.
 (ii) Eddy currents are used in (a) induction furnace (b) induction motor.
19. The electric dipole moment is a vector quantity whose magnitude is equal to the product of charge on one dipole and distance between them. Its direction is from $-q$ to $+q$.

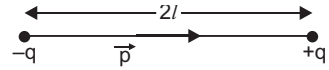

i.e.,
$$\vec{p} = q \cdot 2l$$

Electric dipole moment is a vector quantity.

Derivation of electric field at a point of equatorial plane:

Consider a point P on broad side on the position of dipole formed of charges $+q$ and $-q$ at separation $2l$.

From figure,

$$AP = BP = \sqrt{r^2 + l^2}$$

$$\therefore \vec{E}_1 = \frac{1}{4\pi \epsilon_0} \frac{q}{r^2 + l^2} \text{ along } B \text{ to } P$$

$$\vec{E}_2 = \frac{1}{4\pi \epsilon_0} \frac{q}{r^2 + l^2} \text{ along } P \text{ to } A$$

\therefore Resultant electric field at P is $E = E_1 \cos \theta + E_2 \cos \theta$

But
$$E_1 = E_2 = \frac{1}{4\pi \epsilon_0} \frac{q}{(r^2 + l^2)}$$

and
$$\cos \theta = \frac{OB}{PB} = \frac{l}{\sqrt{r^2 + l^2}} = \frac{l}{(r^2 + l^2)^{1/2}}$$

$$\therefore E = 2E_1 \cos \theta = 2 \times \frac{1}{4\pi \epsilon_0} \frac{q}{(r^2 + l^2)} \cdot \frac{l}{(r^2 + l^2)^{1/2}}$$

$$= \frac{1}{4\pi \epsilon_0} \frac{2ql}{(r^2 + l^2)^{3/2}}$$

But $q \cdot 2l = p =$ electric dipole moment

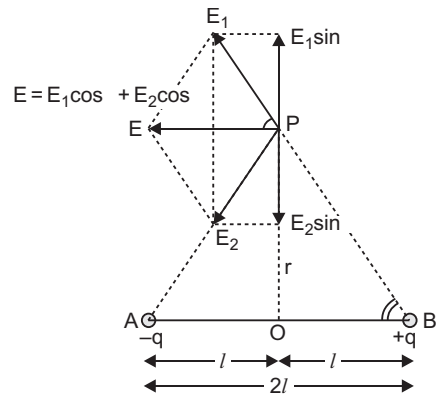

$$\therefore E = \frac{1}{4\pi \epsilon_0} \frac{p}{(r^2 + l^2)^{3/2}} \quad \dots(iii)$$

If dipole is infinitesimal and point P is far away, we have $l \ll r$, so l^2 may be neglected as compared to r^2 and so equation (3) gives

$$E = \frac{1}{4\pi \epsilon_0} \frac{p}{(r^2)^{3/2}}$$

$$E = \frac{1}{4\pi \epsilon_0} \frac{p}{r^3}$$

i.e. electric field strength due to a short dipole at broadside on position

$$E = \frac{1}{4\pi \epsilon_0} \frac{p}{r^3} \text{ parallel to } \vec{BA} \quad \dots(iv)$$

Its direction is parallel to the axis of dipole from positive to negative charge.

20. Kirchhoff's Rules:

(i) **First law (or junction law):** The algebraic sum of currents meeting at any junction is zero,

$$i.e., \quad \Sigma I = 0$$

This law is based on conservation of charge.

(ii) **Second law (or loop law):** The algebraic sum of potential differences of different circuit elements of a closed circuit (or mesh) is zero, *i.e.*,

$$\Sigma V = 0$$

This law is based on conservation of energy.

Numerical: Applying Kirchhoff's second law $\Sigma V = 0$ to given closed circuit along the path $abcda$.

$$\begin{aligned} \Rightarrow \quad & + 2 - Ir_2 - Ir_1 + 2 = 0 \\ & I(r_1 + r_2) = 4 \\ & I = \frac{4}{r_1 + r_2} \end{aligned}$$

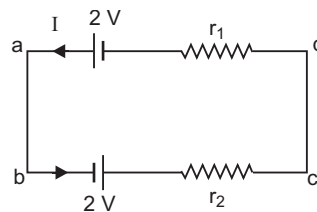

This current is non-zero, so given question is wrong.

However, if terminals of one of the batteries are interchanged, then current is zero.

$$\begin{aligned} \Rightarrow \quad & - 2 - Ir_2 - Ir_1 + 2 = 0 \\ & I = 0 \end{aligned}$$

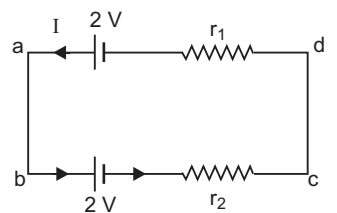

21. (a) Principle of Potentiometer:

Potentiometer works on the fact that the fall of potential across any portion of the wire is directly proportional to the length of that portion provided the wire is of uniform area of cross-section and a constant current is flowing through it.

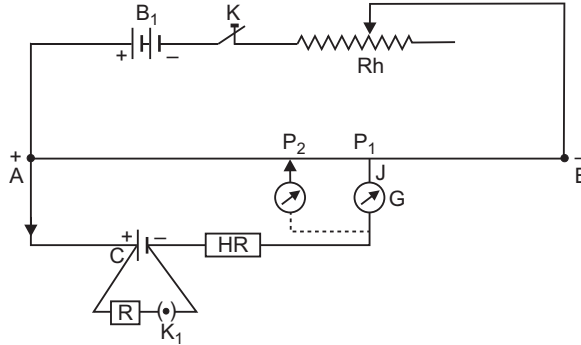

Suppose A and ρ are respectively the area of cross-section and specific resistance of the material of the wire. Let V be the potential difference across the portion of the wire of length l whose resistance is R . If I is the current flowing through the wire, then from Ohm's law;

$$V = IR$$

As
$$R = \frac{\rho l}{A}$$

\therefore
$$V = I\rho \frac{l}{A} \quad \left(\text{where } K = \frac{I\rho}{A} \right)$$

or
$$V \propto I \quad (\text{if } I \text{ and } A \text{ are constant})$$

i.e., potential difference across any portion of potentiometer wire is directly proportional to length of the wire of that portion.

Here,
$$\frac{V}{l} = K = \text{is called potential gradient,}$$

i.e., **the fall of potential per unit length of wire.**

- (b)
- (i) The purpose of high resistance R_2 is to reduce the current through the galvanometer. When jockey is far from balance point, this saves the galvanometer and the cell (of emf ϵ) from being damaged.
 - (ii) When resistance R_1 is decreased, the potential gradient of potentiometer wire increases, so balance point (J) shifts to longer length of wire.
 - (iii) (1) The balance point is not obtained because maximum emf across potentiometer wire is 2 V.
 (2) When key (K) is closed, the terminal potential difference of cell is zero; so balance point cannot be between A and B . (Since $V = kl \Rightarrow l = 0$ for $V = 0$)

22. **Torque on a current carrying loop:** Consider a rectangular loop PQRS of length l , breadth b

suspended in a uniform magnetic field \vec{B} . The length of loop = $PQ = RS = l$ and breadth = $QR = SP = b$. Let at any instant the normal to the plane of loop make an angle θ with the direction of

magnetic field \vec{B} and I be the current in the loop. We know that a force acts on a current carrying wire placed in a magnetic field. Therefore, each side of the loop will experience a force. The net force and torque acting on the loop will be determined by the forces acting on all sides of the loop. Suppose that the forces on sides PQ, QR, RS

and SP are $\vec{F}_1, \vec{F}_2, \vec{F}_3$ and \vec{F}_4 respectively. The sides QR and SP make angle $(90^\circ - \theta)$ with the direction of magnetic field. Therefore each of the

forces \vec{F}_2 and \vec{F}_4 acting on these sides has same magnitude $F' = Blb \sin(90^\circ - \theta) = Blb \cos \theta$. According to Fleming's left hand rule the forces

\vec{F}_2 and \vec{F}_4 are equal and opposite but their line of action is same. Therefore these forces cancel each other i.e. the resultant of \vec{F}_2 and \vec{F}_4 is zero. The sides PQ and RS of current loop are perpendicular to the magnetic field, therefore the magnitude of each of forces \vec{F}_1 and \vec{F}_3 is

$$F = IlB \sin 90^\circ = IlB.$$

According to Fleming's left hand rule the forces \vec{F}_1 and \vec{F}_3 acting on sides PQ and RS are equal and opposite, but their lines of action are different; therefore the resultant force of \vec{F}_1 and \vec{F}_3 is zero, but they form a couple called the *deflecting couple*. When the normal to plane of loop makes an angle θ with the direction of magnetic field B , the perpendicular distance between F_1 and F_3 is $b \sin \theta$.

∴ Moment of couple or Torque,

$$\tau = (\text{Magnitude of one force } F) \times \text{perpendicular distance} = (IlB) \cdot (b \sin \theta) = I(lb) B \sin \theta$$

But $lb = \text{area of loop} = A$ (say)

∴ Torque, $\tau = IAB \sin \theta$

If the loop contains N -turns, then $\tau = NIAB \sin \theta$

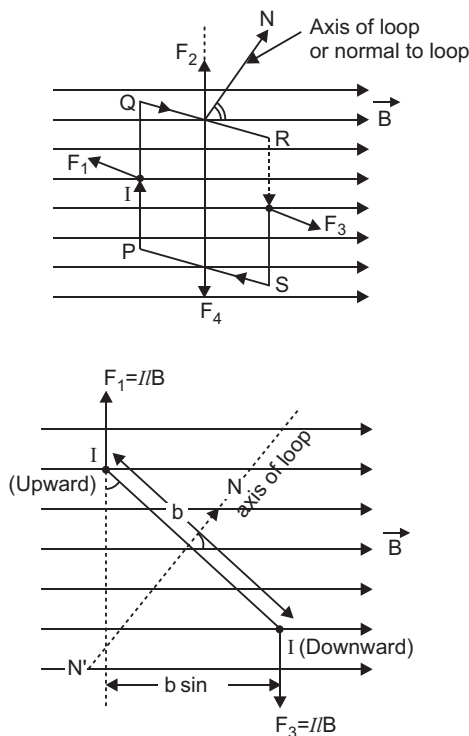

In vector form $\vec{\tau} = NI \vec{A} \times \vec{B}$.

Direction of torque is perpendicular to direction of area of loop as well as the direction of magnetic field *i.e.*, along $I \vec{A} \times \vec{B}$.

OR

Magnetic moment of an electron moving in a circle:

Consider an electron revolving around a nucleus (N) in circular path of radius r with speed v . The revolving electron is equivalent to electric current

$$I = \frac{e}{T}$$

where T is period of revolution = $\frac{2\pi r}{v}$

$$\therefore I = \frac{e}{2\pi r / v} = \frac{ev}{2\pi r} \quad \dots(i)$$

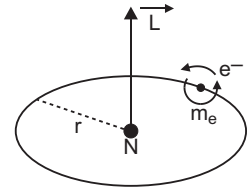

Area of current loop (electron orbit), $A = \pi r^2$

Magnetic moment due to orbital motion,

$$M_l = IA = \frac{ev}{2\pi r} (\pi r^2) = \frac{evr}{2} \quad \dots(ii)$$

This equation gives the magnetic dipole moment of a revolving electron. The direction of magnetic moment is along the axis.

Relation between magnetic moment and angular momentum

Orbital angular momentum of electron

$$L = m_e v r \quad \dots(iii)$$

where m_e is mass of electron,

Dividing (ii) by (iii), we get

$$\frac{M_l}{L} = \frac{evr / 2}{m_e v r} = \frac{e}{2m_e}$$

$$\text{Magnetic moment, } M_l = \frac{e}{2m_e} L \quad \dots(iv)$$

This is expression of magnetic moment of revolving electron in terms of angular momentum of electron.

In vector form

$$\vec{M}_l = -\frac{e}{2m_e} \vec{L} \quad \dots(v)$$

23.

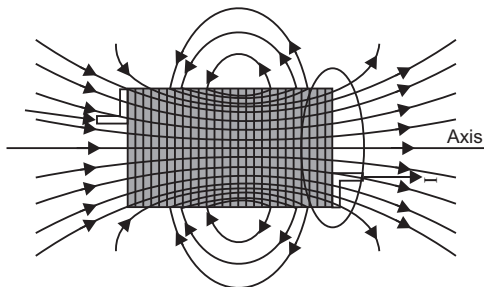

Field lines of a current carrying solenoid

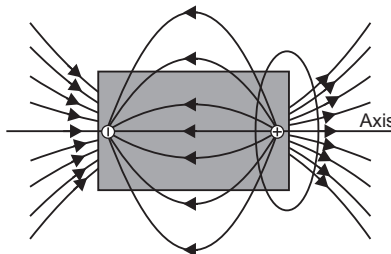

Field lines of an electric dipole

- (i) **Difference:** Field lines of a solenoid form continuous current loops, while in the case of an electric dipole the field lines begin from a positive charge and end on a negative charge or escape to infinity.
- (ii) Two magnetic field lines cannot intersect because at the point of intersection, these will be two directions of magnetic field which is impossible.

24. (i) **The conditions for total internal reflection are**

- (a) The ray must travel from a denser into a rarer medium.
- (b) The angle of incidence $i >$ critical angle C .

(ii) **Numerical:** Given $A = 30^\circ$

When ray is incident normally on the other face, it retraces its path, so $r_2 = 0$.

$$\text{As } r_1 + r_2 = A \Rightarrow r_1 = A - r_2 = 30^\circ - 0 = 30^\circ$$

$$i_1 = 45^\circ$$

$$\text{Refractive index, } n = \frac{\sin i_1}{\sin r_1} = \frac{\sin 45^\circ}{\sin 30^\circ}$$

$$\Rightarrow n = \frac{1 / \sqrt{2}}{1 / 2} = \sqrt{2} = 1.414$$

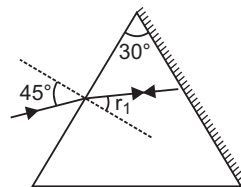

25. (a) We do not encounter diffraction effects of light in everyday observations. To observe diffraction, size of obstacle/aperture must be comparable with wavelength of light but in daily observations size of obstacle/aperture is much larger than the wavelength of light.

$$\text{Angular width of central fringe } \beta_\theta = \frac{2\lambda}{a}$$

(b) (i) If the width of slit is doubled, the (angular) width of central fringe $\left(\propto \frac{1}{a}\right)$ is **halved**.

(ii) When wavelength of light used is increased ($\beta_\theta \propto \lambda$), the width of central fringes increases.

26. (a) The half-life of a radioactive sample is defined as the time in which the mass of sample is left one half of the original mass.

(b) Give $T = 30$ s

(i) Decay constant, $\lambda = \frac{0.6931}{T} = \frac{0.6931}{30} \text{ s}^{-1} = 0.0231 \text{ s}^{-1}$

$$(ii) \frac{N}{N_0} = \left(\frac{1}{2}\right)^n \Rightarrow 1 - \frac{3}{4} = \left(\frac{1}{2}\right)^n \text{ or } \left(\frac{1}{2}\right)^2 = \left(\frac{1}{2}\right)^n$$

$$\text{This gives } n = \frac{t}{T} = 2 \text{ or } t = 2T = 2 \times 30 = 60 \text{ s}$$

27. **Detection:** Detection is the process of recovering the modulating signal from the modulated carrier wave.

Explanation of Detection with the help of a block diagram:

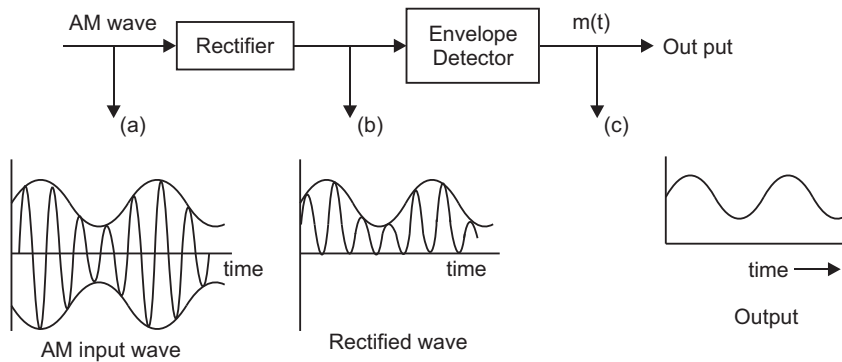

The modulated carrier wave contains frequencies $\omega_c \pm \omega_m$. The detection means to obtain message signal $m(t)$ of frequency ω_m . The method is shown in the form of a block diagram.

The modulated signal is passed through a rectifier. It produces rectified wave [fig. (b)]; the envelope of which is the message signal.

The rectified wave is passed through an envelope detector, whose output is the required message signal $m(t)$.

28. **AC generator:** A dynamo or generator is a device which converts mechanical energy into electrical energy. It is based on the principle of electromagnetic induction.

Construction: It consists of the four main parts:

- (i) **Field Magnet:** It produces the magnetic field. In the case of a low power dynamo, the magnetic field is generated by a permanent magnet, while in the case of large power dynamo, the magnetic field is produced by an electromagnet.
- (ii) **Armature:** It consists of a large number of turns of insulated wire in the soft iron drum or ring. It can revolve round an axle between the two poles of the field magnet. The drum or ring serves the two purposes : (i) It serves as a support to coils and (ii) It increases the magnetic field due to air core being replaced by an iron core.
- (iii) **Slip Rings:** The slip rings R_1 and R_2 are the two metal rings to which the ends of armature coil are connected. These rings are fixed to the shaft which rotates the armature coil so that the rings also rotate along with the armature.
- (iv) **Brushes:** These are two flexible metal plates or carbon rods (B_1 and B_2) which are fixed and constantly touch the revolving rings. The output current in external load R_L is taken through these brushes.

Working: When the armature coil is rotated in the strong magnetic field, the magnetic flux linked with the coil changes and the current is induced in the coil, its direction being given by Fleming’s right hand rule. Considering the armature to be in vertical position and as it rotates in anticlockwise direction, the wire ab moves upward and cd downward, so that the direction of induced current is shown in fig. In the external circuit, the current flows along $B_1R_LB_2$. The direction of current remains unchanged during the first half turn of armature. During the second half revolution, the wire ab moves downward and cd upward, so the direction of current is reversed and in external circuit it flows along $B_2R_LB_1$. Thus the direction of induced emf and current changes in the external circuit after each half revolution.

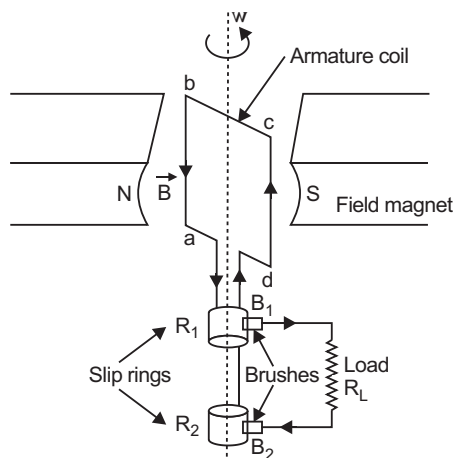

If N is the number of turns in coil, f the frequency of rotation, A area of coil and B the magnetic induction, then induced emf

$$e = -\frac{d\phi}{dt} = \frac{d}{dt} \{NBA (\cos 2\pi f t)\} = 2\pi NBA f \sin 2\pi f t$$

Obviously, the emf produced is alternating and hence the current is also alternating.

Current produced by an ac generator cannot be measured by moving coil ammeter; because the average value of ac over full cycle is zero.

The source of energy generation is the mechanical energy of rotation of armature coil.

When plane of armature coil is parallel to magnetic field, then $\sin \omega t = 1$, so emf is maximum, the maximum value is $e_0 = NBA\omega$

OR

Transformer: Transformer is a device by which an alternating voltage may be decreased or increased. This is based on the principle of mutual-induction.

Construction: It consists of laminated core of soft iron, on which two coils of insulated copper wire are separately wound. These coils are kept insulated from each other and from the iron-core, but are coupled through mutual induction. The number of turns in these coils are different. Out of these coils one coil is called *primary coil* and other is called the *secondary coil*. The terminals of primary coils are connected to AC mains and the terminals of the secondary coil are connected to external circuit in which alternating current of desired voltage is required.

Step up Transformer: It transforms the alternating low voltage to alternating high

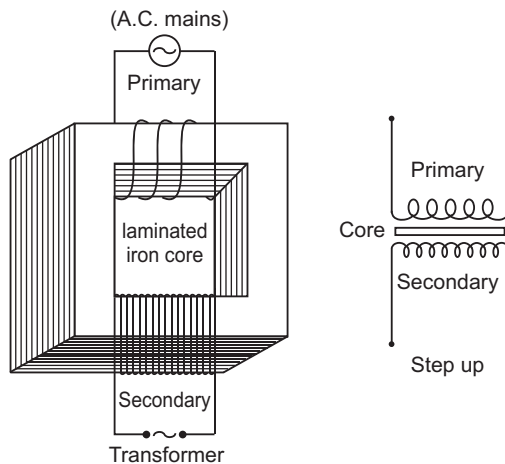

voltage and in this the number of turns in secondary coil is more than that in primary coil. (i.e., $N_S > N_p$).

Working: When alternating current source is connected to the ends of primary coil, the current changes continuously in the primary coil; due to which the magnetic flux linked with the secondary coil changes continuously, therefore the alternating emf of same frequency is developed across the secondary.

Let N_p be the number of turns in primary coil, N_S the number of turns in secondary coil and ϕ the magnetic flux linked with each turn. *We assume that there is no leakage of flux so that the flux linked with each turn of primary coil and secondary coil is the same.* According to Faraday's laws the emf induced in the primary coil

$$\varepsilon_p = -N_p \frac{\Delta\phi}{\Delta t} \quad \dots(i)$$

and emf induced in the secondary coil

$$\varepsilon_S = -N_S \frac{\Delta\phi}{\Delta t} \quad \dots(ii)$$

From (1) and (ii)

$$\frac{\varepsilon_S}{\varepsilon_p} = \frac{N_S}{N_p} \quad \dots(iii)$$

If the resistance of primary coil is negligible, the emf (ε_p) induced in the primary coil, will be equal to the applied potential difference (V_p) across its ends. Similarly if the secondary circuit is open, then the potential difference V_S across its ends will be equal to the emf (ε_S) induced in it; therefore

$$\frac{V_S}{V_p} = \frac{\varepsilon_S}{\varepsilon_p} = \frac{N_S}{N_p} = r \text{ (say)} \quad \dots(iv)$$

where $r = \frac{N_S}{N_p}$ is called the *transformation ratio*. If i_p and i_s are the instantaneous currents in

primary and secondary coils and there is no loss of energy; then

For about 100% efficiency, Power in primary = Power in secondary

$$\begin{aligned} V_p i_p &= V_S i_S \\ \therefore \frac{i_S}{i_p} &= \frac{V_p}{V_S} = \frac{N_p}{N_S} = \frac{1}{r} \quad \dots(v) \end{aligned}$$

In step up transformer, $N_S > N_p \rightarrow r > 1$;

So $V_S > V_p$ and $i_S < i_p$

i.e., step up transformer increases the voltage.

Power Transmission Over Long Distances

The power (electrical energy) is transmitted to long distances by the use of transformers. The voltage output of the generator is stepped up by means of step up transformer, this steps down the current, so power loss I^2R is significantly reduced. At the receiving station the voltage is stepped down to 220 V for domestic supply.

29. (a) Lens Maker's Formula: Suppose

L is a thin lens. The refractive index of the material of lens is n_2 and it is placed in a medium of refractive index n_1 . The optical centre of lens is C and $X'X$ is principal axis. The radii of curvature of the surfaces of the lens are R_1 and R_2 and their poles are P_1 and P_2 . The thickness of lens is t , which is very small. O is a point object on the principal axis of the lens. The distance of O from pole P_1 is u . The first refracting surface forms the image of O at I' at a distance v' from P_1 . From the refraction formula at spherical surface

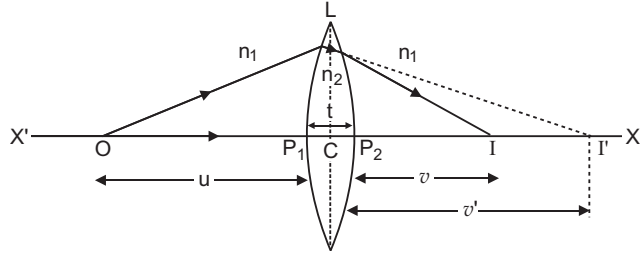

$$\frac{n_2}{v'} - \frac{n_1}{u} = \frac{n_2 - n_1}{R_1} \quad \dots(i)$$

The image I' acts as a virtual object for second surface and after refraction at second surface, the final image is formed at I . The distance of I from pole P_2 of second surface is v . The distance of virtual object (I') from pole P_2 is $(v' - t)$.

For refraction at second surface, the ray is going from second medium (refractive index n_2) to first medium (refractive index n_1), therefore from refraction formula at spherical surface

$$\frac{n_1}{v} - \frac{n_2}{(v' - t)} = \frac{n_1 - n_2}{R_2} \quad \dots(ii)$$

For a thin lens t is negligible as compared to v' , therefore from (ii)

$$\frac{n_1}{v} - \frac{n_2}{(v')} = - \frac{n_2 - n_1}{R_2} \quad \dots(iii)$$

Adding equations (i) and (iii), we get

$$\frac{n_1}{v} - \frac{n_1}{u} = (n_2 - n_1) \left(\frac{1}{R_1} - \frac{1}{R_2} \right)$$

or
$$\frac{1}{v} - \frac{1}{u} = \left(\frac{n_2}{n_1} - 1 \right) \left(\frac{1}{R_1} - \frac{1}{R_2} \right)$$

i.e.
$$\frac{1}{v} - \frac{1}{u} = ({}_1n_2 - 1) \left(\frac{1}{R_1} - \frac{1}{R_2} \right) \quad \dots(iv)$$

where ${}_1n_2 = \frac{n_2}{n_1}$ is refractive index of second medium (i.e. medium of lens) with respect to first medium.

If the object O is at infinity, the image will be formed at second focus i.e.

if $u = \infty$, $v = f_2 = f$

Therefore from equation (iv)

$$\frac{1}{f} - \frac{1}{\infty} = ({}_1n_2 - 1) \left(\frac{1}{R_1} - \frac{1}{R_2} \right)$$

i.e.
$$\frac{1}{f} = ({}_1n_2 - 1) \left(\frac{1}{R_1} - \frac{1}{R_2} \right) \quad \dots(v)$$

This is the formula of refraction for a thin lens. This formula is called **Lens-Maker's formula**.

If first medium is air and refractive index of material of lens be n , then ${}_1n_2 = n$, therefore equation (v) may be written as

$$\frac{1}{f} = (n - 1) \left(\frac{1}{R_1} - \frac{1}{R_2} \right) \quad \dots(vi)$$

(b) Power of a Lens: The power of a lens is its ability to deviate the rays towards its principal axis. It is defined as the reciprocal of focal length in metres.

$$\text{Power of a lens, } P = \frac{1}{f \text{ (in metres)}} \text{ diopters} = \frac{100}{f \text{ (in cm)}} \text{ diopters}$$

The SI unit for power of a lens is dioptre (D).

Numerical:

$$\text{Power of convex lens, } P_1 = \frac{1}{F_1} \text{ D} = \frac{1}{0.50} = 2.0 \text{ D}$$

$$\text{Power of concave lens, } P_2 = \frac{1}{F_2} \text{ D} = \frac{1}{-0.20} = -5.0 \text{ D}$$

\therefore Power of combination of lenses in contact

$$P = P_1 + P_2 = 2.0 \text{ D} - 5.0 \text{ D} = -3.0 \text{ D}$$

OR

Astronomical Telescope: Magnifying power of astronomical telescope in normal adjustment is defined as the ratio of the angle subtended at the eye by the final image to the angle subtended at the eye, by the object directly, when the final image and the object both lie at infinite distance from the eye.

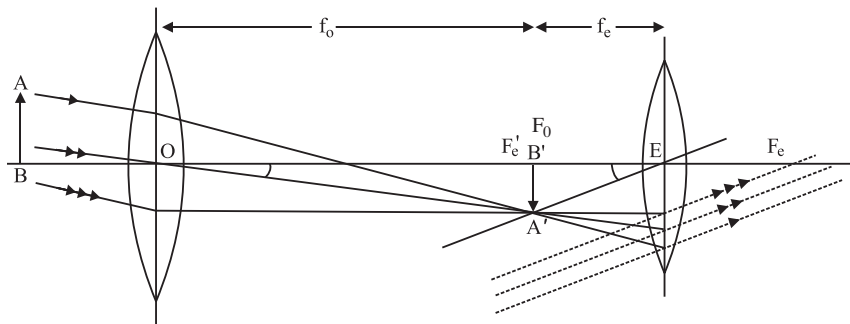

$$\text{Magnifying power, } m = \frac{\beta}{\alpha} \tag{1}$$

As angles α and β are small, therefore, $\alpha \approx \tan \alpha$ and $\beta \approx \tan \beta$.

From equation (1),
$$m = \frac{\tan \beta}{\tan \alpha} \tag{2}$$

In $\Delta A'B'C_2$,
$$\tan \beta = \frac{A'B'}{C_2B'}$$

In $\Delta A'B'C_1$,
$$\tan \alpha = \frac{A'B'}{C_1B'}$$

Put in equation (2),
$$m = \frac{A'B'}{C_2B'} \times \frac{C_1B'}{A'B'} = \frac{C_1B'}{C_2B'}$$

or
$$m = \frac{f_0}{-f_e}$$

where $C_1B' = f_0 =$ focal length of objective lens,

$C_2B' = -f_e =$ focal length of eye lens.

Negative sign of m indicates that final image is inverted.

The diameter of objective is kept large to increase (i) intensity of image, (ii) resolving power of telescope.

Distinction

	Telescope	Compound Microscopes
1.	Objective lens is of large focal length and eye lens is of small focal length.	Both objective and eye lenses are of small focal lengths but focal length of eye lens is larger than that of objective lens.
2.	Objective is of very large aperture.	Objective is of small aperture.

30. (a) Formation of Depletion Layer and Potential Barrier

At the junction there is diffusion of charge carriers due to thermal agitation; so that some of electrons of n -region diffuse to p -region while some of holes of p -region diffuse into n -region. Some charge carriers combine with opposite charges to neutralise each other. Thus near the junction there is an excess of positively charged ions in n -region and an excess of negatively charged ions in p -region. This sets up a **potential difference** called potential barrier and hence an internal electric field E_i across the junctions. The field E_i is directed from n -region to p -region. This field stops the further diffusion of charge carriers. Thus the layers ($\approx 10^{-4}$ cm to 10^{-6} cm) on either side of the junction becomes free

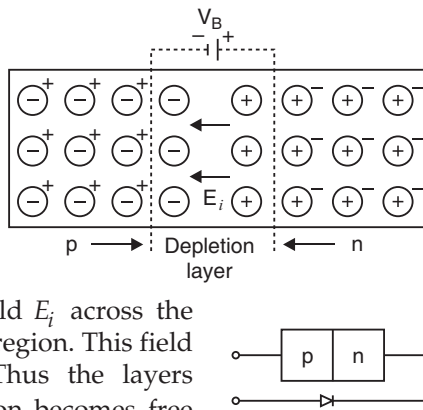

from mobile charge carriers and hence is called the *depletion layer*. The symbol of *p-n* junction diode is shown in Figure.

(b) Full Wave Rectifier: For full wave rectifier we use two junction diodes. The circuit diagram for full wave rectifier using two junction diodes is shown in figure.

Suppose during first half cycle of input ac signal the terminal S_1 is positive relative to S and S_2 is negative relative to S , then diode I is forward biased and diode II is reverse biased.

Therefore current flows in diode I and not in diode II. The direction of current i_1 due to diode I in load resistance R_L is directed from A to B . In next half cycle, the terminal S_1 is negative relative to S and S_2 is positive relative to S . Then diode I is reverse biased and diode II is forward biased. Therefore current flows in diode II and there is no current in diode I. The direction of current i_2 due to diode II in load resistance is again from A to B . Thus for input a.c. signal the output current is a continuous series of unidirectional pulses. This output current may be converted in fairly steady current by the use of suitable filters.

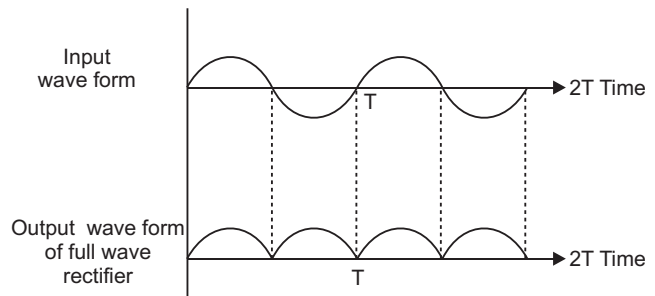
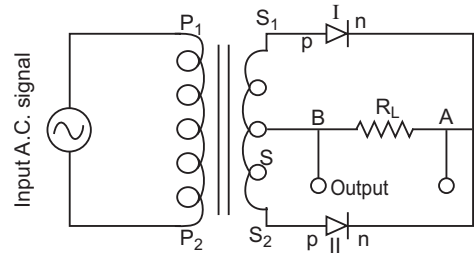

OR

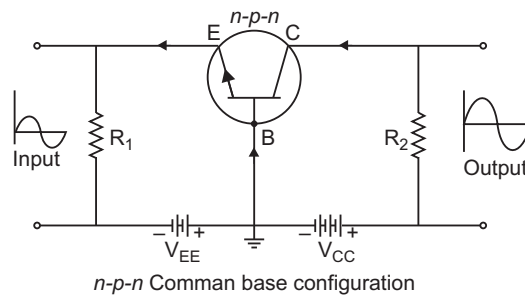

Base Current and Collector Current: Under forward bias of emitter-base junction, the electrons in emitter and holes in base are compelled to move towards the junction, thus the depletion layer of emitter-base junction is eliminated. As the base region is very thin, most electrons (about 98%) starting from emitter region cross the base region and reach the collector while only a few of them (about 2%) combine with an equal number of holes of base-region and get neutralised. As soon as a hole (in *P*-region) combines with an electron, a covalent bond of crystal atom of base region breaks releasing an electron-hole pair. The

electron released is attracted by positive terminal of emitter battery V_{EE} , giving rise to a feeble base current (I_B). Its direction in external circuit is from emitter to base. The hole released in the base region compensates the loss of hole neutralised by electrons.

The electrons crossing the base and entering the collector, due to reverse biasing of collector-base junction, are attracted towards the positive terminal of collector battery V_{CC} .

In the process an equal number of electrons leave the negative terminal of battery V_{CC} and enter the positive terminal of battery V_{EE} . This causes a current in collector circuit, called the collector current. In addition to this the collector current is also due to flow of minority charge carriers under reverse bias of base-collector junction. This current is called the leakage current.

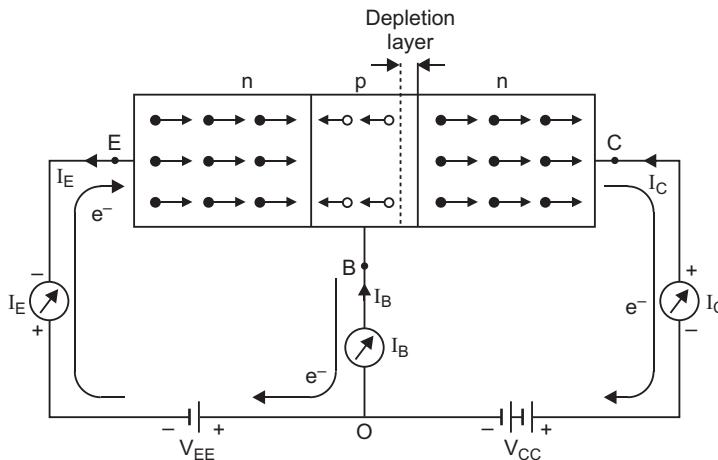

Thus, collector current is formed of two components:

- (i) Current (I_{nc}) due to flow of electrons (majority charge carriers) moving from emitter to collector.
- (ii) leakage current ($I_{leakage}$) due to minority charge carriers, *i.e.*, $I_c = I_{nc} + I_{leakage}$.

Emitter Current: When electrons enter the emitter battery V_{EE} from the base causing base current or electrons enter the collector battery V_{CC} from the collector causing collector current, an equal number of electrons enter from emitter battery V_{EE} to emitter, causing the emitter current. The process continues.

Relation between Emitter, Base and Collector Currents:

Applying Kirchoff's I law at terminal O , we get

$$I_E = I_B + I_C$$

That is, the emitter current I_E is the sum of base current I_B and the collector current I_C . This is the fundamental relation between currents in the bipolar transistor circuit.

Transistor as a Switch

A switch is a device which can turn ON and OFF current in an electrical circuit.

A transistor can be used to turn current ON or OFF rapidly in electrical circuits.

Operation: The circuit diagram of $n-p-n$ transistor in CE configuration working as a switch is shown in fig. V_{BB} and V_{CC} are two dc supplies which bias base-emitter and emitter collector junctions respectively.

Let V_{BB} be the input supply voltage. This is also input dc voltage (V_C). The dc output voltage is taken across collector-emitter terminals, R_L is the load resistance in output circuit.

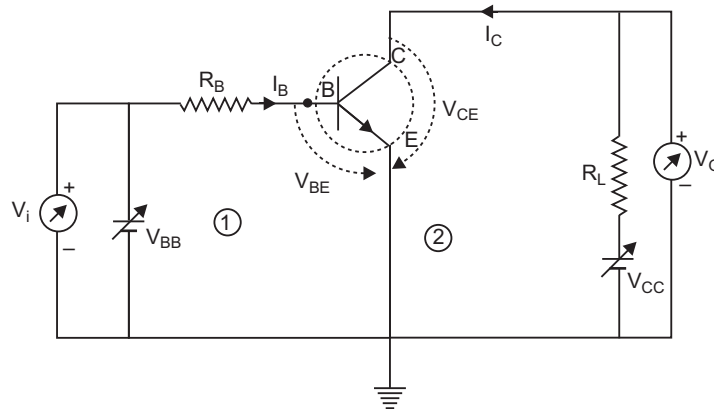

Applying Kirchhoff's second law to input and output meshes (1) and (2), we get

$$V_{BB} = I_B R_B + V_{BE} \quad \dots(i)$$

and
$$V_{CC} = I_C R_L + V_{CE} \quad \dots(ii)$$

We have $V_{BB} = V_i$ and $V_{CE} = V_0$, so above equations take the form

$$V_i = V_{BE} + I_B R_B \quad \dots(iii)$$

and
$$V_0 (= V_{CE}) = V_{CC} - I_C R_L \quad \dots(iv)$$
 Let us see the change in V_0 due to a change in V_i . In case of Si transistor; the barrier voltage across base-emitter junction is 0.6 V . Therefore, when V_i is less than 0.6 V , there is no collector current ($I_C = 0$), so transistor will be in cut off state. Hence, from (iv) with $I_C = 0$; $V_0 = V_{CC}$.

When V_i becomes greater than 0.6 V , I_C begins to flow and increase with increase of V_i . Thus, from (iv), V_0 decreases upto $V_i = 1 \text{ V}$; the increase in I_C is linear and so decrease in output voltage V_0 is **linear**.

Beyond $V_i = 1 \text{ V}$, the change in collector current and hence in output voltage V_0 is non-linear and the transistor goes into saturation. With further increase in V_i , the output voltage further decrease towards zero (though it never becomes zero).

If we plot V_0 versus V_i , we get the graph as shown in fig. [This characteristics curve is also called transfer characteristic curve of base biased transistor.]

The curve shows that there are non-linear regions.

(i) between cut off state and active state and (ii) between active state and saturation state; thus showing that the transitions (i) from cut off to active state and from active to saturation state are not sharply defined.

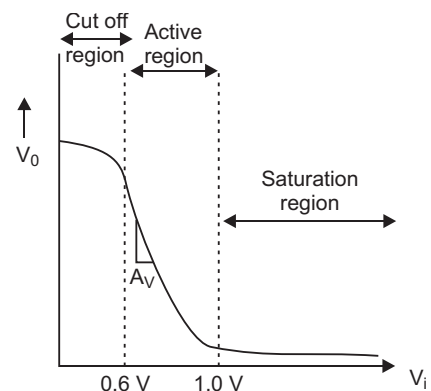

Now we are in the position to explain the action of **transistor as a switch**. When transistor is non-conducting ($I_C = 0$), it is said to be '**switched off**' but when it is conducting (I_C is not zero); it is said to be '**switched ON**'.

As long as input voltage V_i is low and unable to overcome the barrier voltage of the emitter base junction, V_0 is high ($I_C = 0$ and $V_0 = V_{CC}$), so the transistor is 'switched OFF' and if it is high enough to derive the transistor into saturation (I_C is high and so $V_0 (= V_{CC} - I_C R_L)$ is low, very near to zero, so the transistor is 'switched ON'. Thus we can say low input switches the transistor is **OFF state** and high input switches it ON.

The switching circuits are designed in such a way that the transistor does not remain in active state.

CBSE (Foreign) SET-II

- When the current in a coil is changed, a back emf is induced in the same coil. This phenomenon is called self-induction.
- The rays coming out of the convex lens, when point source is at focus, are parallel, so wavefront is **plane** (figure).

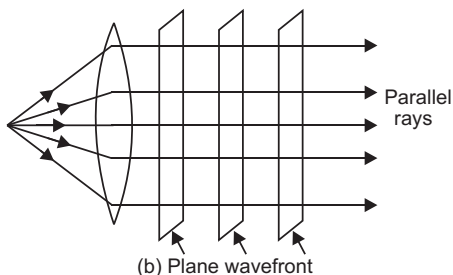

- Name of gate formed is **NOR gate** symbol.



Truth Table

Inputs		Output
A	B	Y
0	0	1
1	0	0
0	1	0
1	1	0

- For particle to move undeviated,

$$q \vec{E} + q \vec{v} \times \vec{B} = 0$$

$$\Rightarrow \vec{E} = - \vec{v} \times \vec{B}$$

Given $\vec{v} = -v\hat{i}$, $\vec{B} = -B\hat{k}$

$\therefore \vec{E} = -(-v\hat{i}) \times (-B\hat{k}) = -vB(-\hat{j}) = vB\hat{j}$

i.e., magnitude of electric field is vB and its direction is along positive Y-axis.

13. (a) The frequency of incident radiation was kept constant.
 (b) de-Broglie wavelength,

$$\lambda = \frac{h}{\sqrt{2mqV}} \propto \frac{1}{\sqrt{V}}$$

If potential difference V is doubled, the de-Broglie wavelength is decreased to $\frac{1}{\sqrt{2}}$ times.

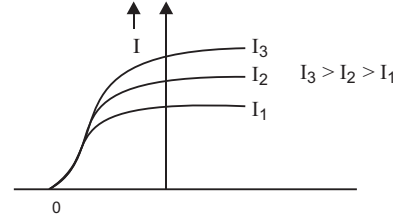

14. **After OR** $q_1 + q_2 = 9 \times 10^{-6} \text{ C}$... (1)

$$\frac{1}{4\pi\epsilon_0} \frac{q_1 q_2}{r^2} = 2$$

$$\Rightarrow q_1 q_2 = \frac{2 \times (0.30)^2}{9 \times 10^9} = 20 \times 10^{-12}$$

$$(q_1 - q_2) = (q_1 + q_2)^2 - 4q_1 q_2 = 81 \times 10^{-12} - 80 \times 10^{-12} = 1 \times 10^{-12} \quad \dots (2)$$

Solving (1) and (2) $q_1 = 5 \mu\text{C}$, $q_2 = 4 \mu\text{C}$

16. **Microwaves:**

Uses: 1. In Radar for aircraft navigation.

2. In microwave ovens to heat the food.

23. (i) A diamagnetic substance is attracted towards a region of weaker magnetic field.
 (ii) (a) **Permanent magnets** are made of steel which is characterised by **high retentivity** and **high coercivity**.
 (b) **Electromagnets** are made of soft iron which is characterised by **high retentivity** and **low coercivity**.

26. (a) (i) **Amplitude Modulation**

In amplitude modulation, the amplitude of modulated (carrier) wave varies in accordance with amplitude of information (signal) wave. When amplitude of information increases, the amplitude of modulated wave increases and vice versa. In this case the amplitude of modulated wave is not constant.

- (ii) **Modulation Index:** The modulation index of an amplitude modulated wave is defined as the ratio of the amplitude of modulating signal (E_m) to the amplitude of carrier wave (E_c) *i.e.*, amplitude modulation index,

$$m_a = \frac{E_m}{E_c}$$

For modulated wave,

$$m_a = \frac{E_{\max} - E_{\min}}{E_{\max} + E_{\min}}$$

(b) The modulation is needed due to

- (i) Transmission of audiofrequency electrical signals need long impracticable antenna.
- (ii) The power radiated at audio frequency is quite small, hence transmission is quite lossy.
- (iii) The various information signals transmitted at low frequency get mixed and hence can not be distinguished.

27. (a) **Half-life period:** The half-life period of a radioactive substance is defined as the time in which one-half of the radioactive substance is disintegrated.

(b) (i) Given $T = 20$ s

$$\text{Decay constant, } \lambda = \frac{0.6931}{T} = \frac{0.6931}{20} \text{ s}^{-1} = 0.0346 \text{ s}^{-1} = 0.0346 \text{ s}^{-1}$$

(ii) Fraction decayed = $\frac{7}{8}$

$$\text{Fraction remained } \frac{N}{N_0} = 1 - \frac{7}{8} = \frac{1}{8}$$

$$\therefore \frac{N}{N_0} = \left(\frac{1}{2}\right)^n \text{ gives}$$

$$\frac{1}{8} = \left(\frac{1}{2}\right)^n \Rightarrow \left(\frac{1}{2}\right)^3 = \left(\frac{1}{2}\right)^n$$

$$\text{Number of half lives, } n = 3, \quad \Rightarrow \quad t = 3T = 3 \times 20 \text{ s} = 60 \text{ s}$$

CBSE (Foreign) SET-III

1. By introducing the metal plate between the plates of charged capacitor, the capacitance of capacitor increases.

Reason: If t is thickness of metal plate, then

$$C = \frac{\epsilon_0 A}{d - t \left(1 - \frac{1}{K}\right)}$$

$$\text{For metal plate } K = \infty, \quad C = \frac{\epsilon_0 A}{(d - t)}$$

Obviously, effective separation between plates is decreased from d to $(d - t)$.

4. **Mutual Inductance:** The mutual inductance of two coils is defined as the magnetic flux linked with the secondary coil when the current in primary coil is 1 ampere.
6. Electromagnetic radiation produced by a Klystron or a Magnetron valve is **microwave**.
- 8.i **Wavefront:** The locus of particles of a medium vibrating in the same phase is called a wavefront. From a point source, the wavefront is spherical; while for a line source the wavefront is cylindrical. The distant wavefront is plane.
9. (i) Charges induced on outer surfaces of P_1 and P_2 are $-Q$ and $+Q$ respectively.

When plates are released, they will tend to move away from one another; plate P_1 moving towards $+Q$ and P_2 towards $-Q$ due to attraction.

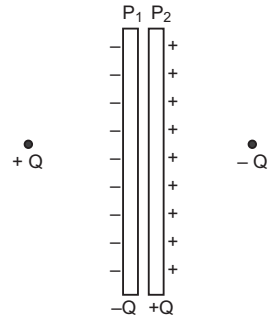

(ii) The field pattern is shown in fig.

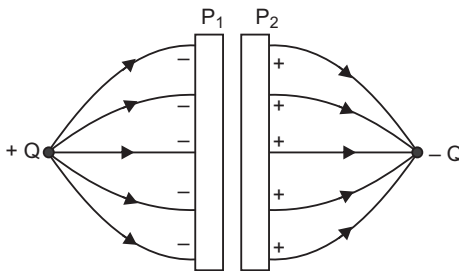

10. Common potential, $V = \frac{C_1 V_1 + 0}{C_1 + C_2}$
 $= \frac{(800 \text{ pF}) \times 100}{800 + 800} \text{ V} = 50 \text{ V}$

Net capacitance, $C = C_1 + C_2 = 1600 \text{ pF}$

$$\begin{aligned} \text{Energy stored} &= \frac{1}{2} (C_1 + C_2) V^2 \\ &= \frac{1}{2} \times 1600 \times 10^{-12} \times (50)^2 \text{ J} \\ &= 2 \times 10^{-6} \text{ J} \end{aligned}$$

13. X-rays

Uses: (i) To study crystal structure.

(ii) to detect fracture in bones, stone in gall bladder and kidney etc.

14. NAND gate.



Truth Table

A	B	Y
0	0	1
1	0	1
0	1	1
1	1	0

16. Intensity of incident radiations was kept constant. Frequency ν_1 is highest.

24. (i) Angle of dip decreases from 90° to 0° as one goes from magnetic pole to magnetic equator of earth.

(ii) X is diamagnetic and Y is ferromagnetic.

26. (b) (i) $\lambda = \frac{0.6931}{50} \text{ s}^{-1} \approx 0.014 \text{ s}^{-1}$

(ii) $\frac{N}{N_0} = \left(\frac{1}{2}\right)^n \Rightarrow \left(\frac{1}{4}\right) = \left(\frac{1}{2}\right)^n$

$n = 2 \Rightarrow t = 2T = 2 \times 50 \text{ s} = 100 \text{ s}$

CBSE EXAMINATION PAPERS

DELHI-2010

Time allowed: 3 hours

Maximum marks: 70

General Instructions:

- (a) All questions are compulsory.
- (b) There are 30 questions in total. Questions 1 to 8 carry one mark each, questions 9 to 18 carry two marks each, questions 19 to 27 carry three marks each and questions 28 to 30 carry five marks each.
- (c) There is no overall choice. However, an internal choice has been provided in one question of two marks, one question of three marks and all three questions of five marks each. You have to attempt only one of the given choices in such questions.
- (d) Use of calculators is not permitted.
- (e) You may use the following values of physical constants wherever necessary:

$$c = 3 \times 10^8 \text{ ms}^{-1} \qquad h = 6.626 \times 10^{-34} \text{ Js}$$

$$e = 1.602 \times 10^{-19} \text{ C} \qquad \mu_0 = 4\pi \times 10^{-7} \text{ TmA}^{-1}$$

$$\frac{1}{4\pi\epsilon_0} = 9 \times 10^9 \text{ Nm}^2\text{C}^{-2}$$

Boltzmann's constant $k = 1.381 \times 10^{-23} \text{ JK}^{-1}$

Avogadro's number $N_A = 6.022 \times 10^{23} / \text{mole}$

Mass of neutron $m_n = 1.675 \times 10^{-27} \text{ kg}$

Mass of electron $m_e = 9.1 \times 10^{-31} \text{ kg}$

Radius of earth = 6400 km

CBSE (Delhi) SET-I

1. In which orientation, a dipole placed in a uniform electric fields is in (i) stable, (ii) unstable equilibrium?
2. Which part of electromagnetic spectrum has largest penetrating power?
3. A plot of magnetic flux (Φ) versus current (I) is shown in the figure for two inductors A and B. Which of the two has larger value of self inductance?

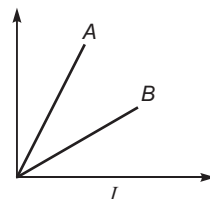

4. Figure shows three point charges, $2q$, q and $3q$. Two charges $2q$ and q are enclosed within a surface 'S'. What is the electric flux due to this configuration through the surface 'S'?

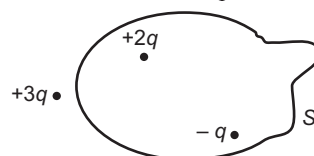

5. A glass lens of refractive index 1.45 disappears when immersed in a liquid. What is the value of refractive index of the liquid?
6. What is the ratio of radii of the orbits corresponding to first excited state and ground state in a hydrogen atom?
7. A wire of resistance $8R$ is bent in the form of a circle. What is the effective resistance between the ends of a diameter AB ?

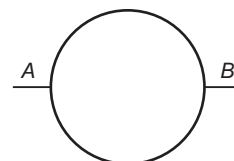

8. State the conditions for the phenomenon of total internal reflection to occur.
9. Explain the function of a repeater in a communication system.
10. (i) Write two characteristics of a material used for making permanent magnets.
(ii) Why is core of an electromagnet made of ferromagnetic materials?

OR

Draw magnetic field lines when a (i) diamagnetic, (ii) paramagnetic substance is placed in an external magnetic field. Which magnetic property distinguishes this behaviour of the field lines due to the two substances?

11. Draw the circuit diagram of an illuminated photodiode in reverse bias. How is photodiode used to measure light intensity?
12. An electric lamp having coil of negligible inductance connected in series with a capacitor and an AC source is glowing with certain brightness. How does the brightness of the lamp change on reducing the (i) capacitance, and (ii) the frequency? Justify your answer.

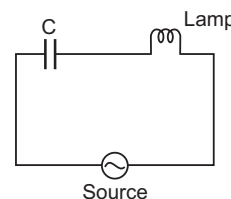

13. Arrange the following electromagnetic radiations in ascending order of their frequencies:
 - (i) Microwave
 - (ii) Radio wave
 - (iii) X-rays
 - (iv) Gamma rays

Write two uses of any one of these.

14. The radii of curvature of the faces of a double convex lens are 10 cm and 15 cm. If focal length of the lens is 12 cm, find the refractive index of the material of the lens.
15. An electron is accelerated through a potential difference of 100 volts. What is the de-Broglie wavelength associated with it? To which part of the electromagnetic spectrum does this value of wavelength correspond?
16. A heavy nucleus X of mass number 240 and binding energy per nucleon 7.6 MeV is split into two fragments Y and Z of mass numbers 110 and 130. The binding energy of nucleons in Y and Z is 8.5 MeV per nucleon. Calculate the energy Q released per fission in MeV.
17. (a) The bluish colour predominates in clear sky.
(b) Violet colour is seen at the bottom of the spectrum when white light is dispersed by a prism. State reason to explain these observations.

18. Plot a graph showing the variation of stopping potential with the frequency of incident radiation for two different photosensitive materials having work functions W_1 and W_2 ($W_1 > W_2$). On what factors does the (i) slope and (ii) intercept of the lines depend?
19. A parallel plate capacitor is charged by a battery. After sometime the battery is disconnected and a dielectric slab with its thickness equal to the plate separation is inserted between the plates. How will (i) the capacitance of the capacitor, (ii) potential difference between the plates and (iii) the energy stored in the capacitor be affected?

Justify your answer in each case.

20. Write the principle of working of a potentiometer. Describe briefly, with the help of a circuit diagram, how a potentiometer is used to determine the internal resistance of a given cell.

21. Write the expression for the magnetic moment (m) due to a planar square loop of side ' l ' carrying a steady current I in a vector form.

In the given figure this loop is placed in a horizontal plane near a long straight conductor carrying a steady current I_1 at a distance l as shown. Give reasons to explain that the loop will experience a net force but no torque. Write the expression for this force acting on the loop.

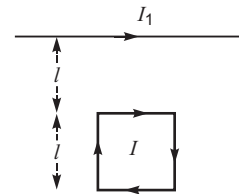

22. (a) Depict the equipotential surfaces for a system of two identical positive point charges placed a distance ' d ' apart.
 (b) Deduce the expression for the potential energy of a system of two point charges q_1 and q_2 brought from infinity to the points r_1 and r_2 respectively in the presence of external electric field E .
23. What is an unpolarized light? Explain with the help of suitable ray diagram how an unpolarized light can be polarized by reflection from a transparent medium. Write the expression for Brewster angle in terms of the refractive index of denser medium.
24. (i) Define 'activity' of a radioactive material and write its S.I. unit.
 (ii) Plot a graph showing variation of activity of a given radioactive sample with time.
 (iii) The sequence of stepwise decay of a radioactive nucleus is



If the atomic number and mass number of D_2 are 71 and 176 respectively, what are their corresponding values for D ?

25. A long straight wire of a circular cross-section of radius ' a ' carries a steady current ' I '. The current is uniformly distributed across the cross-section. Apply Ampere's circuital law to calculate the magnetic field at a point ' r ' in the region for (i) $r < a$ and (ii) $r > a$.

OR

State the underlying principle of working of a moving coil galvanometer. Write two reasons why a galvanometer can not be used as such to measure current in a given circuit. Name any two factors on which the current sensitivity of a galvanometer depends.

26. What is space wave propagation? Give two examples of communication system which use space wave mode.

A TV tower is 80 tall. Calculate the maximum distance upto which the signal transmitted from the tower can be received.

27. In a meter bridge, the null point is found at a distance of 40 cm from A. If a resistance of 12 Ω is connected in parallel with S, the null point occurs at 50.0 cm from A. Determine the values of R and S.

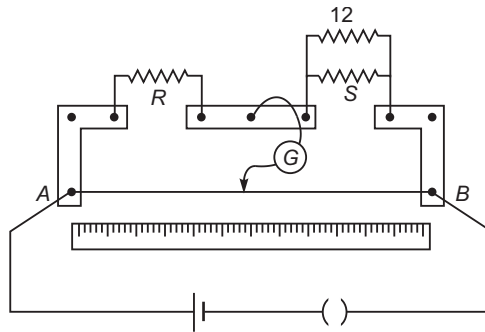

28. Describe briefly, with the help of a labelled diagram, the basic elements of an AC generator. State its underlying principle. Show diagrammatically how an alternating emf is generated by a loop of wire rotating in a magnetic field. Write the expression for the instantaneous value of the emf induced in the rotating loop.

OR

A series *LCR* circuit is connected to an ac source having voltage $v = v_m \sin t$. Derive the expression for the instantaneous current *I* and its phase relationship to the applied voltage.

Obtain the condition for resonance to occur. Define ‘power factor’. State the conditions under which it is (i) maximum and (ii) minimum.

29. State Huygen’s principle. Show, with the help of a suitable diagram, how this principle is used to obtain the diffraction pattern by a single slit.

Draw a plot of intensity distribution and explain clearly why the secondary maxima become weaker with increasing order (*n*) of the secondary maxima.

OR

Draw a ray diagram to show the working of a compound microscope. Deduce an expression for the total magnification when the final image is formed at the near point.

In a compound microscope, an object is placed at a distance of 1.5 cm from the objective of focal length 1.25 cm. If the eye piece has a focal length of 5 cm and the final image is formed at the near point, estimate the magnifying power of the microscope.

30. (a) Explain the formation of depletion layer and potential barrier in a *p-n* junction.
 (b) In the figure given below, the input waveform is converted into the output wave from a device ‘X’. Name the device and draw its circuit diagram.

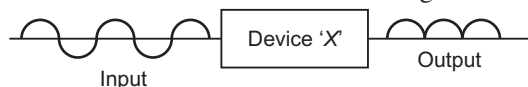

- (c) Identify the logic gate represented by the circuit as shown and write its truth table.

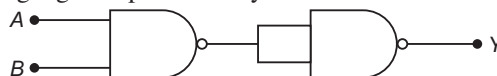

22. In a meter bridge, the null point is found at a distance of 60.0 cm from A. If now a resistance of 5 Ω is connected in series with S, the null point occurs at 50 cm. Determine the values of R and S.

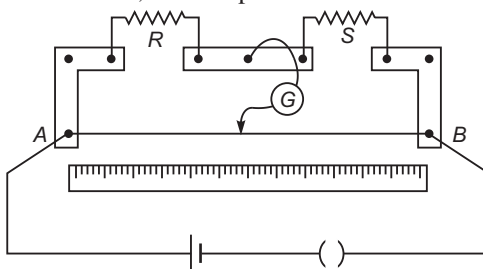

CBSE (Delhi) SET-III

Questions uncommon to Set-I

4. Which part of electromagnetic spectrum is used in radar systems?
5. Calculate the speed of light in a medium whose critical angle is 30° .
7. Write the expression for Bohr's radius in hydrogen atom.
11. What is the range of frequencies used in satellite communication? What is common between these waves and light waves?
12. A coil Q is connected to low voltage bulb B and placed near another coil P is shown in the figure. Give reason to explain the following observations:

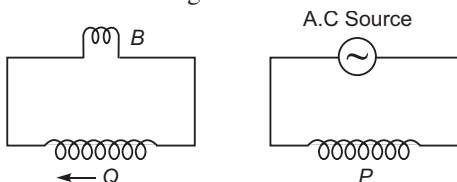

- (a) The bulb 'B' lights.
- (b) Bulb gets dimmer if the coil Q is moved towards left.
13. Find the radius of curvature of the convex surface of a plano-convex lens, whose focal length is 0.3 m and the refractive index of the material of the lens is 1.5.
14. An electron is accelerated through a potential difference of 64 volts. What is the de-Broglie wavelength associated with it? To which part of the electromagnetic spectrum does this value of wavelength correspond?
15.
 - (i) Out of blue and red light which is deviated more by a prism? Give reason.
 - (ii) Give the formula that can be used to determine refractive index of material of a prism in minimum deviation condition.
20. In a metre bridge, the null point is found at a distance of l_1 cm from A. If now a resistance of X is connected in parallel with S, the null point occurs at l_2 cm. Obtain a formula for X in terms of l_1 , l_2 and S.

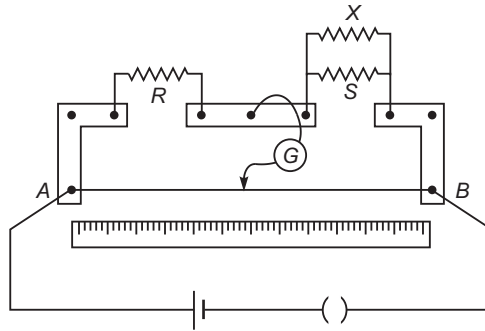

27. A parallel plate capacitor is charged to a potential difference V by a d.c. source. The capacitor is then disconnected from the source. If the distance between the plates is doubled, state with reason how the following will change:
- electric field between the plates.
 - capacitance, and
 - energy stored in the capacitor.

Solutions

CBSE (Delhi) Set-I

- In stable equilibrium the dipole moment is parallel to the direction of electric field (*i.e.*, $\theta = 0$).
 - In unstable equilibrium P.E. is maximum, so $\theta = 180^\circ$ so dipole moment is antiparallel to electric field.
- γ -rays have largest penetrating power.
- $L I$

For same current $I_A = I_B$, so $L_A > L_B$
i.e., Inductor A has larger value of self-inductance.

- Electric flux, $\frac{1}{\epsilon_0} \int \vec{E} \cdot d\vec{S}$ (net charge enclosed by surface S)

$$\frac{1}{\epsilon_0} (2q - q) = \frac{q}{\epsilon_0}$$
- For disappearance of glass lens in liquid, refractive index of liquid = refractive index of lens **1 45**

$$6. \quad r_n = \frac{0.5 h^2 n^2}{m e^2} \quad n^2$$

For I excited state, $n = 2$

For ground state, $n = 1$

$$\frac{r_2}{r_1} = \frac{4}{1}$$

7. Two parts each of resistance $4R$ are connected in parallel; so effective resistance across ends of diameter AB is

$$\frac{4R}{4R} + \frac{4R}{4R} = 2R$$

8. Conditions for total internal reflection are:
 (i) Light must travel from denser to rarer medium.
 (ii) Angle of incidence must be greater than critical angle (C).
9. A repeater is a combination of a receiver and a transmitter. Repeaters are used to increase the range of communication of signals. A repeater picks up the signal from the transmitter, amplifiers and retransmits it to the receiver, sometimes with a change in carrier frequency. A typical example of repeater station is a communication satellite.
10. (i) For permanent magnet the material must have high **retentivity** and high **coercivity** (*e.g.*, steel).
 (ii) Ferromagnetic material has high retentivity, so when current is passed in ferromagnetic material it gains sufficient magnetism immediately on passing a current through it.

OR

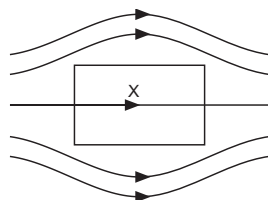

(a) Diamagnetic substance

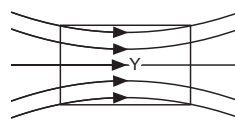

(b) Paramagnetic substance

The magnetic susceptibility of diamagnetic substance is **small and negative** but that of paramagnetic substance is **small and positive**.

11. It is a reversed biased p-n junction, illuminated by radiation. When p-n junction is reversed biased with no current, a very small reverse saturated current flows across the junction called the dark current. When the junction is illuminated with light, electron-hole pairs are created at the junction, due to which additional current begins to flow across the junction; the current is solely due to minority charge carriers.

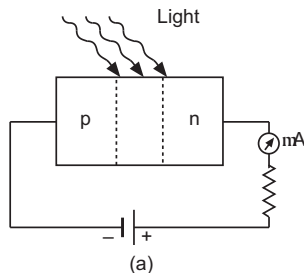

(a)

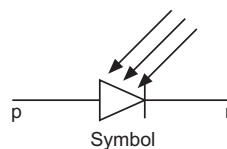

(b)

Photodiode

12. (i) When capacitance is reduced, capacitive reactance $X_C = \frac{1}{C}$ increases, hence impedance of circuit, $Z = \sqrt{R^2 + X_C^2}$ increases and so current $I = \frac{V}{Z}$ decreases. As a result **the brightness of the bulb is reduced.**

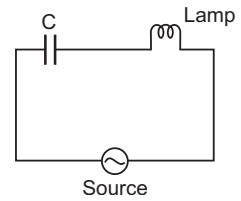

- (ii) When frequency decreases; capacitive reactance $X_C = \frac{1}{2\pi nC}$ increases and hence impedance of circuit increases, so current decreases. As a result brightness of bulb is reduced.
13. In ascending order of frequencies: radiowaves, microwaves, ultraviolet rays, X-rays and gamma rays.

Uses of Electromagnetic Spectrum

- (i) **-rays** are highly penetrating, they can penetrate thick iron blocks. Due to high energy, they are used to produce nuclear reactions. γ -rays are produced in nuclear reactions. In medicine, they are used to destroy cancer cells.
- (ii) **X-rays** are used in medical diagnostics to detect fractures in bones, tuberculosis of lungs, presence of stone in gallbladder and kidney. They are used in engineering to check flaws in bridges. In physics X-rays are used to study crystal structure.
- (iii) **Radiowaves** are used for broadcasting programmes to distant places. According to frequency range, they are divided into following groups
- (1) Medium frequency band or medium waves 0.3 to 3 MHz
 - (2) Short waves or short frequency band 3 MHz — 30 MHz
 - (3) Very high frequency (VHF) band 30 MHz to 300 MHz
 - (4) Ultrahigh frequency (UHF) band 300 MHz to 3000 MHz
- (iv) **Microwaves** are produced by special vacuum tubes, namely; klystrons, magnetrons and gunn diodes. Their frequency range is 3 GHz to 300 GHz. They are used in radar systems used in air craft navigation and microwave users in houses.
14. Given $R_1 = 10$ cm, $R_2 = 15$ cm, $f = 12$ cm

Refractive index $n = ?$

Lens-maker's formula is

$$\frac{1}{f} = (n - 1) \left(\frac{1}{R_1} - \frac{1}{R_2} \right)$$

$$\frac{1}{12} = (n - 1) \left(\frac{1}{10} - \frac{1}{15} \right)$$

$$(n - 1) = \frac{5}{30}$$

$$n - 1 = \frac{30}{5} \cdot \frac{1}{12} \quad \text{or} \quad n - 1 = \frac{30}{60} \quad n - 1 = 0.5 \quad n = 1.5$$

15. $\frac{h}{\sqrt{2meV}}$ $\frac{6.63 \times 10^{-34}}{\sqrt{2 \times 9.1 \times 10^{-31} \times 1.6 \times 10^{19} \times 100}}$ m

$$1.227 \times 10^{-10} \text{ m} = 1.227 \text{ \AA}$$

This wavelength corresponds to X-ray region of *em* spectrum.

16. $Q = (M_y - M_z) c^2 = M c^2$
 $8.5 \times 240 \text{ MeV} - 7.6 \times 240 \text{ MeV}$
 $(8.5 - 7.6) \times 240 \text{ MeV}$
 $0.9 \times 240 \text{ MeV} = \mathbf{216 \text{ MeV}}$

17. (a) The intensity of scattered light varies inversely as fourth power of wavelength *i.e.*, $I \propto \frac{1}{\lambda^4}$.

In visible light blue colour has minimum wavelength, so it is scattered most, that is why bluish colour predominates in a clear sky.

- (b) While light consists of infinite wavelengths starting from 400 nm (violet) to 750 nm (red). The refractive index of prism is maximum for violet and minimum for red; so prism separates constituent colours of white light and causes maximum deviation for violet colour. That is why violet colour is seen at the bottom of spectrum when white light is dispersed through a prism.

18. The graph of stopping potential V_s and frequency (ν) for two metals 1 and 2 is shown in fig.

- (i) Slope of graph $\tan \theta = \frac{h\nu_0}{e}$ and depends on h and e .
 (ii) Intercept of lines depend on the work function.

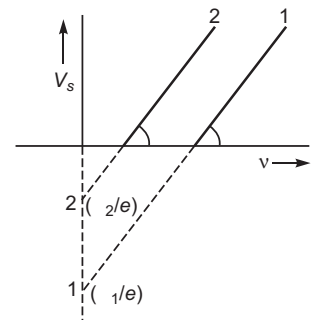

19. (i) The capacitance of capacitor increases to K times (since $C = \frac{K \epsilon_0 A}{d} = K C_0$)
 (ii) The potential difference between the plates becomes $\frac{1}{K}$ times.

Reason: $V = \frac{Q}{C}$; Q same, C increases to K times; $V = \frac{V_0}{K}$

- (iii) As $E = \frac{V}{d}$ and V is decreased; therefore, electric field decreases to $\frac{1}{K}$ times. Energy stored by the capacitor, $U = \frac{Q^2}{2C}$. As Q constant, C is increased, and so energy stored by capacitor decreases to $\frac{1}{K}$ times.

20. **Principle:** If constant current is flowing through a wire of uniform area of cross-section at constant temperature, the potential drop across any portion of wire is directly proportional to the length of that portion

i.e., $V \propto l$

Method: (i) Initially key K is closed and a potential difference is applied across the wire AB . Now rheostat (R_h) is so adjusted that on touching the jockey J at ends A and B of

potentiometer wire, the deflection in the galvanometer is on both sides. Suppose that in this position the potential gradient on the wire is k .

(ii) Now key K_1 is kept open and the position of null deflection is obtained by sliding and pressing the jockey on the wire. Let this position be P_1 and $AP_1 = l_1$. In this situation the cell is in open circuit, therefore the terminal potential difference will be equal to the emf of cell, i.e.,

$$\text{emf} = kl_1 \quad \dots(i)$$

(iii) Now a suitable resistance R is taken in the resistance box and key K_1 is closed. Again, the position of null point is obtained on the wire by using jockey J . Let this position on wire be P_2 and $AP_2 = l_2$.

In this situation the cell is in closed circuit, therefore the terminal potential difference (V) of cell will be equal to the potential difference across external resistance R , i.e.,

$$V = kl_2 \quad \dots(ii)$$

Dividing (i) by (ii), we get $\frac{\text{emf}}{V} = \frac{l_1}{l_2}$

$$\text{Internal resistance of cell, } r = \frac{\text{emf}}{V} - 1 = R \left(\frac{l_1}{l_2} - 1 \right)$$

From this formula r may be calculated.

21. Magnetic moment due to a planar square loop of side l carrying current I is

$$m = IA$$

For square loop $A = l^2$

$$m = Il^2 \hat{n}$$

where \hat{n} is unit vector normal to loop.

Magnetic field due to current carrying wire at the location of loop is directed downward perpendicular to plane of loop.

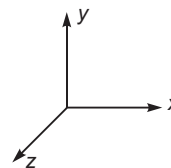
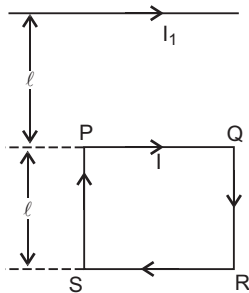
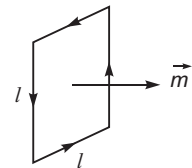
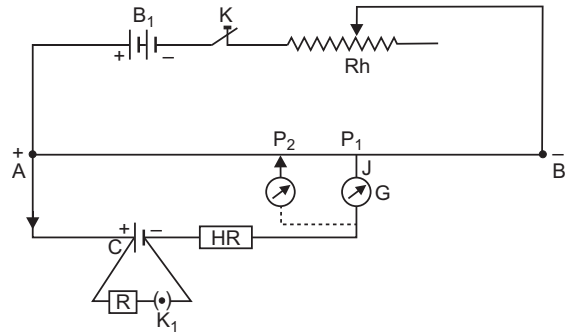

Force on QR and SP are equal and opposite, so net force on these sides is zero.

Force on side PQ , $F_{PQ} = I l B_1 \hat{i}$

$$= I l \left(\frac{\mu_0 I_1}{2 l} \right) (\hat{k})$$

$$= \frac{\mu_0 I_1 I}{2} \hat{j};$$

Force on side RS , $F_{RS} = I l (-\hat{i}) = -\frac{\mu_0 I_1 I}{2} (\hat{k})$

Net force $F = F_{PQ} + F_{RS} = \frac{\mu_0 I_1 I}{4} \hat{j};$

Torque $\tau = r \times F = l \hat{j} \times \frac{\mu_0 I_1 I}{4} \hat{j};$

$$= (2l \hat{j}) \times \frac{\mu_0 I_1 I}{4} \hat{j} = \text{zero}$$

That is loop experiences a repulsive force but no torque.

22. (a) Equipotential surfaces due to two identical charges is shown in fig.

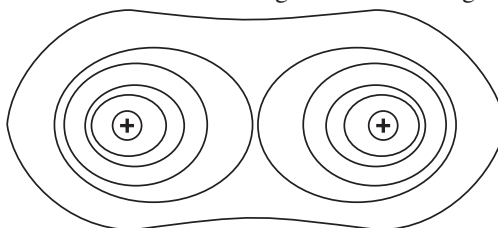

- (b) Potential energy of a system of two charges in an external electric field.

Suppose q_1 and q_2 are two charges brought from infinity at locations r_1 and r_2 respectively in an external electric field.

Let $V(r_1)$ and $V(r_2)$ be the potentials at positions r_1 and r_2 due to external electric field E . In this case work is done in bringing charges q_1 and q_2 against their own electric fields and external electric fields.

Work done in bringing charge q_1 from ∞ at location r_1 is $W_1 = q_1 V(r_1)$

Work done in bringing q_2 against the electric field at location r_2 is $W_2 = q_2 V(r_2)$

Work done on q_2 against the electric field due to q_1 is

$$W_3 = \int_{\infty}^{r_2} F_{12} \cdot dr = \frac{1}{4\pi\epsilon_0} \int_{\infty}^{r_2} \frac{q_1 q_2}{r^2} \hat{r} \cdot (\hat{r} dr)$$

$$= \frac{1}{4\pi\epsilon_0} q_1 q_2 \int_{\infty}^{r_2} \frac{1}{r^2} dr$$

$$\frac{1}{4\pi\epsilon_0} q_1 q_2 \frac{1}{r} = \frac{1}{4\pi\epsilon_0} \frac{q_1 q_2}{r_{12}}$$

where $r_{12} = |r_2 - r_1|$

Potential energy of system = Work done in assembling the configuration

$$U = W_1 + W_2 + W_3 = q_1 V(r_1) + q_2 V(r_2) = \frac{1}{4\pi\epsilon_0} \frac{q_1 q_2}{|r_2 - r_1|}$$

- 23. Unpolarised light:** The light having vibrations of electric field vector in all possible directions perpendicular to the direction of wave propagation is called the ordinary (or unpolarised) light.

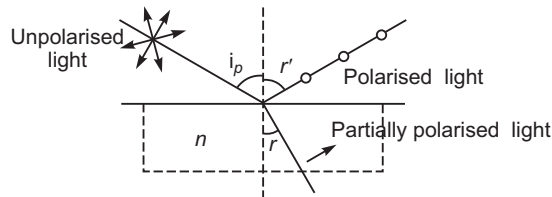

If unpolarised light falls on a transparent surface of refractive index n at a certain angle i_p , called polarising angle, then reflected light is plane polarised with its electric vector perpendicular to the plane of incidence when the refracted and reflected rays make a right angle with each other.

Brewster's law: $n = \tan i_p$.

- 24.** (i) The activity of a radioactive substance is the rate of decay or the number of disintegrations per second of the substance.
 (ii)

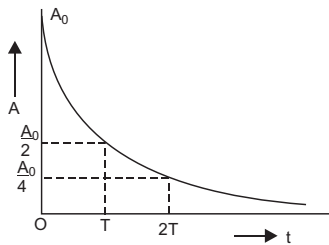

(iii) The sequence is represented as ${}^A_Z D$, ${}^A_{Z-2} D$, ${}^A_{Z-4} D$

- (i) Given $A = 176$ Mass number of D , $A = 180$
 (ii) $Z = 71$ Atomic number of D , $Z = 72$.

25. Magnetic Field due to a straight thick wire of uniform cross-section: Consider an infinitely long cylindrical wire of radius a , carrying current I . Suppose that the current is uniformly distributed over whole cross-section of the wire. The cross-section of wire is circular. Current per unit cross-sectional area.

$$i = \frac{I}{a^2} \quad \dots(i)$$

Magnetic Field at External Points: We consider a circular path of radius r ($r > a$) passing through external point P concentric with circular cross-section of wire. By symmetry the strength of magnetic field at every point of circular path is same and the direction of magnetic field is tangential to path at every point. So

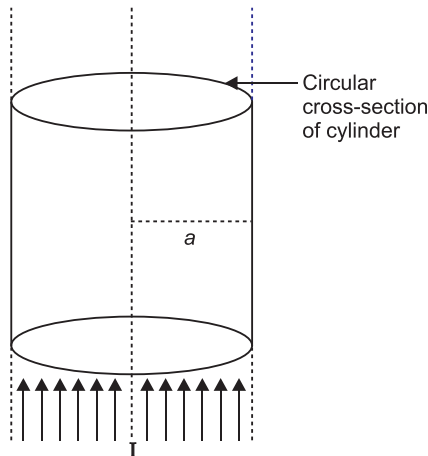

line integral of magnetic field \mathbf{B} around the circular path

$$\oint \mathbf{B} \cdot d\mathbf{l} = \oint B \, dl \cos 0 = B \cdot 2\pi r$$

Current enclosed by path = Total current on circular cross-section of cylinder = I

By Ampere's circuital law

$$\oint \mathbf{B} \cdot d\mathbf{l} = \mu_0 \text{ current enclosed by path}$$

$$B \cdot 2\pi r = \mu_0 I$$

$$B = \frac{\mu_0 I}{2\pi r}$$

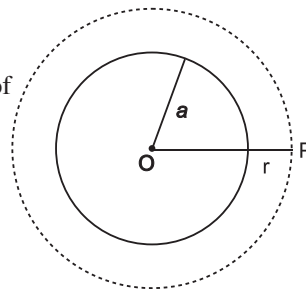

This expression is same as the magnetic field due to a long current carrying straight wire. This shows that for external points the current flowing in wire may be supposed to be concerned at the axis of cylinder.

Magnetic Field at Internal Points: Consider a circular path of radius r ($r < a$), passing through internal point Q , concentric with circular cross-section of the wire. In this case the assumed circular path encloses only a path of current carrying circular cross-section of the wire.

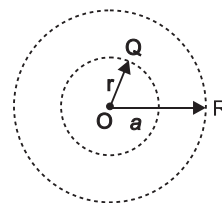

Current enclosed by path

= current per unit cross-section \times cross section of assumed circular path

$$i \cdot \pi r^2 = \frac{I}{a^2} \cdot \pi r^2 = \frac{I r^2}{a^2}$$

By Ampere's circuital law

$$\oint \mathbf{B} \cdot d\mathbf{l} = \mu_0 \text{ current enclosed by path}$$

$$B = \frac{\mu_0 I r}{2 a^2}$$

$$B = \frac{\mu_0 I r}{2 a^2}$$

Clearly, magnetic field strength inside the current carrying wire is directly proportional to distance of the point from the axis of wire.

At surface of cylinder $r = a$, so magnetic field at surface of wire

$$B_s = \frac{\mu_0 I}{2 a} \quad (\text{maximum value})$$

The variation of magnetic field strength (B) with distance (r) from the axis of wire for internal and external points is shown in figure.

$$B_{\text{outside}} = \frac{\mu_0 I}{2 r} = \frac{\mu_0 I}{2 a} \cdot \frac{a}{r} = \frac{\mu_0 I}{2 a} \cdot \frac{a}{r}$$

$$B_{\text{inside}} = \frac{\mu_0 I r}{2 a^2} = \frac{\mu_0 I (a/2)}{2 a^2} = \frac{\mu_0 I}{4 a}$$

$$\frac{B_{\text{outside}}}{B_{\text{inside}}} = \frac{4}{3}$$

Maximum value of magnetic field is at the surface given by $B_{\text{outside}} = \frac{\mu_0 I}{2 a}$

OR

Principle: When current (I) is passed in the coil, torque acts on the coil, given by

$$NIAB \sin \theta$$

where θ is the angle between the normal to plane of coil and the magnetic field of strength B , N is the number of turns in a coil.

When the magnetic field is radial, as in the case of cylindrical pole pieces and soft iron core, then in every position of coil the plane of the coil, is parallel to the magnetic field lines, so that $\theta = 90^\circ$ and $\sin 90^\circ = 1$

Deflecting torque, $\tau = NIAB$

A galvanometer cannot be used as such to measure current due to following two reasons.

- (i) A galvanometer has a finite large resistance and is connected in series in the circuit, so it will increase the resistance of circuit and hence change the value of current in the circuit.
- (ii) A galvanometer is a very sensitive device, it gives a full scale deflection for the current of the order of microampere, hence if connected as such it will not measure current of the order of ampere.

Current sensitivity of galvanometer depends on

- (i) **Number of turns N :** It increases with increase of number of turns.
- (ii) **Area of coil A :** It increases with increase of area of coil.
- (iii) **Strength of magnetic poles (B):** It increases with increase of strength of poles.

(iv) **Torsional rigidity of suspension:** It increases with decrease of torsional rigidity of suspension.

26. Space wave propagation is a straight line propagation of electromagnetic wave from transmitting antenna to receiving antenna both installed in the ground.

Maximum coverage distance

$$d = \sqrt{2R_e h}$$

$$\sqrt{2 \times 6400 \times 10^3 \times 80} = 32 \times 10^3 \text{ m} = 32 \text{ km}$$

27. In first case $l_1 = 40 \text{ cm}$

$$\frac{R}{S} = \frac{l_1}{100} = \frac{40}{100} = \frac{2}{5} \quad \dots(i)$$

In second case when S and 12 are in parallel balancing length $l_2 = 50 \text{ cm}$, so

$$S = \frac{12S}{12} = \frac{12S}{S} \quad \dots(ii)$$

$$\frac{R}{S} = \frac{50}{100} = \frac{1}{2} \quad \dots(iii)$$

From (i) $S = \frac{3}{2}R$

Substituting this value in (ii), we get

$$S = \frac{12 \times \frac{3}{2}R}{12 \times \frac{3}{2}R} = \frac{18R}{12 \times \frac{3}{2}R}$$

Also from equation (iii), $S = \frac{3}{2}R$

$$\frac{18R}{12 \times \frac{3}{2}R} = \frac{3}{2}R$$

$$\frac{18}{12 \times \frac{3}{2}} = \frac{3}{2}$$

$$\frac{18}{18} = \frac{3}{2}$$

$$1 = \frac{3}{2}$$

$$S = \frac{3}{2}R = 6$$

$R = 4, S = 6$

28. AC generator consists of the four main parts:

(i) **Field Magnet:** It produces the magnetic field. In the case of a low power dynamo, the magnetic field is generated by a permanent magnet, while in the case of large power dynamo, the magnetic field is produced by an electromagnet.

(ii) **Armature:** It consists of a large number of turns of insulated wire in the soft iron drum or ring. It can revolve round an axle between the two poles of the field magnet. The drum or ring serves the two purposes: (i) It serves as a support to coils and (ii) It increases the magnetic field due to air core being replaced by an iron core.

- (iii) **Slip Rings:** The slip rings R_1 and R_2 are the two metal rings to which the ends of armature coil are connected. These rings are fixed to the shaft which rotates the armature coil so that the rings also rotate along with the armature.
- (iv) **Brushes:** These are two flexible metal plates or carbon rods (B_1 and B_2) which are fixed and constantly touch the revolving rings. The output current in external load R_L is taken through these brushes.

Principle: When the armature coil is rotated in the strong magnetic field, the magnetic flux linked with the coil changes and the current is induced in the coil, its direction being given by Fleming's right hand rule. The direction of current remains unchanged during the first half turn of armature. During the second half revolution, the direction of current is reversed. Thus, the direction of induced emf and current changes in the external circuit after each half revolution.

If N is the number of turns in coil, f the frequency of rotation, A area of coil and B the magnetic induction, then induced emf

$$e = \frac{d}{dt} \frac{d}{dt} \{NBA (\cos 2 \pi f t)\}$$

$$= 2 \pi NBA f \sin 2 \pi f t$$

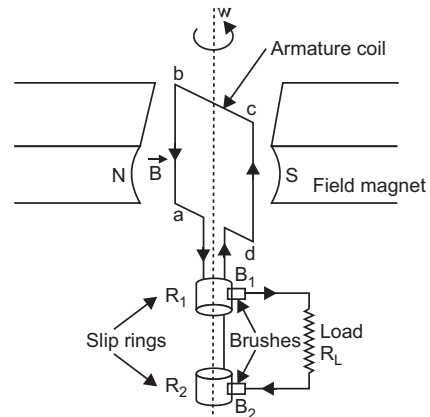

OR

Suppose resistance R , inductance L and capacitance C are connected in series and an alternating source of voltage $V = V_0 \sin \omega t$ is applied across it. (fig. a) On account of being in series, the current (i) flowing through all of them is the same.

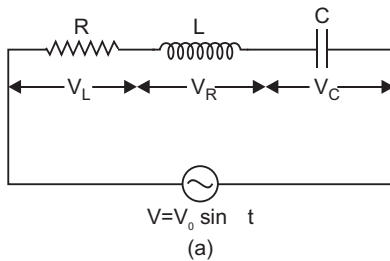

Suppose the voltage across resistance R is V_R , voltage across inductance L is V_L and voltage across capacitance C is V_C . The voltage V_R and current i are in the same phase, the voltage V_L will lead the current by angle 90° while the voltage V_C will lag behind the current by angle 90° (fig. b). Clearly V_C and V_L are in opposite directions, therefore their resultant potential difference $V_C - V_L$ (if $V_C > V_L$).

Thus V_R and $(V_C - V_L)$ are mutually perpendicular and the phase difference between them is 90° . As applied voltage across the circuit is V , the resultant of V_R and $(V_C - V_L)$ will also be V . From fig.

$$V^2 = V_R^2 + (V_C - V_L)^2 \quad \Rightarrow \quad V = \sqrt{V_R^2 + (V_C - V_L)^2} \quad \dots(i)$$

But $V_R = Ri, V_C = X_C i$ and $V_L = X_L i$...*(ii)*

where $X_C = \frac{1}{C}$ capacitance reactance and $X_L = L$ inductive reactance

$$\text{Impedance of circuit, } Z = \frac{V}{i} = \frac{\sqrt{(Ri)^2 + (X_C i - X_L i)^2}}{i}$$

i.e. $Z = \sqrt{R^2 + (X_C - X_L)^2} = \sqrt{R^2 + \left(\frac{1}{C} - L\right)^2}$

Instantaneous current $I = \frac{V_0 \sin(\omega t)}{\sqrt{R^2 + \left(\frac{1}{C} - L\right)^2}}$

Condition for resonance to occur in series LCR ac circuit:

For resonance the current produced in the circuit and emf applied must always be in the same phase.

Phase difference (ϕ) in series LCR circuit is given by

$$\tan \phi = \frac{X_C - X_L}{R}$$

For resonance $\phi = 0$ $X_C = X_L = 0$

or $X_C = X_L$

If ω is resonant frequency, then $X_C = \frac{1}{\omega C}$

and

$$\frac{1}{\omega C} = \omega L \quad \omega = \frac{1}{\sqrt{LC}}$$

Power factor is the cosine of phase angle ϕ , *i.e.*, $\cos \phi = \frac{R}{Z}$.

For maximum power

$$\cos \phi = 1 \quad \text{or} \quad Z = R$$

i.e., circuit is purely resistive.

For minimum power

$$\cos \phi = 0 \quad \text{or} \quad R = 0$$

i.e., circuit should be free from ohmic resistance.

29. Principle:

- (i) Every point on a given wavefront may be regarded as a source of new disturbance.
- (ii) The new disturbances from each point spread out in all directions with the velocity of light and are called the *secondary wavelets*.
- (iii) The surface of tangency to the secondary wavelets in forward direction at any instant gives the new position of the wavefront at that time.

Let us illustrate this principle by the following example:

Let AB shown in the fig. be the section of a wavefront in a homogeneous isotropic medium at $t = 0$. We have to find the position of the wavefront at time t using Huygens' principle. Let v be the velocity of light in the given medium.

- (a) Take the number of points 1, 2, 3, ... on the wavefront AB . These points are the sources of secondary wavelets.
- (b) At time t the radius of these secondary wavelets is vt . Taking each point as centre, draw circles of radius vt .
- (c) Draw a tangent A_1B_1 common to all these circles in the forward direction.

Propagation of wavefront from a point source:

When monochromatic light is made incident on a single slit, we get diffraction pattern on a screen placed behind the slit. The diffraction pattern contains bright and dark bands, the intensity of central band is maximum and goes on decreasing on both sides.

Let AB be a slit of width ' a ' and a parallel beam of monochromatic light is incident on it. According to Fresnel the diffraction pattern is the result of superposition of a large number of waves, starting from different points of illuminated slit.

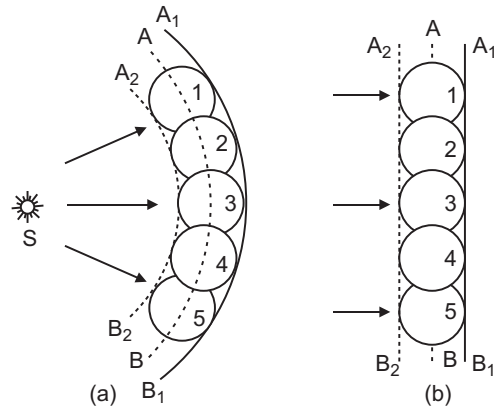

Let θ be the angle of diffraction for waves reaching at point P of screen and AN the perpendicular dropped from A on wave diffracted from B .

The path difference between rays diffracted at points A and B ,

$$BP - AP = BN$$

In $\triangle ANB$, $\angle ANB = 90^\circ$ and $\angle BAN = \theta$

$$\sin \theta = \frac{BN}{AB} \text{ or } BN = AB \sin \theta$$

As $AB =$ width of slit $= a$

Path difference,

$$a \sin \theta \quad \dots(i)$$

To find the effect of all coherent waves at P , we have to sum up their contribution, each with a different phase. This was done by Fresnel by rigorous calculations, but the main features may be explained by simple arguments given below:

At the central point C of the screen, the angle θ is zero. Hence the waves starting from all points of slit arrive in the same phase. This gives maximum intensity at the central point C .

If point P on screen is such that the path difference between rays starting from edges A and B is λ , then path difference

$$a \sin \theta = \lambda \text{ or } \sin \theta = \frac{\lambda}{a}$$

If angle is small,

$$\sin \frac{\theta}{a}$$

...(ii)

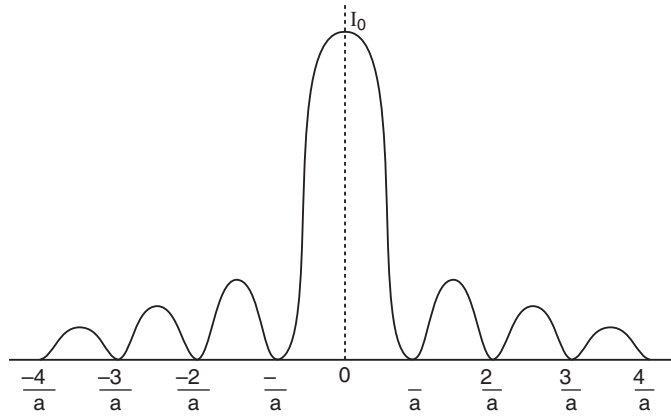

The intensity of secondary maxima decreases with increase of order n because with increasing n , the contribution of slit decreases.

For $n = 2$, it is one-fifth, for $n = 3$, it is one-seventh and so on.

OR

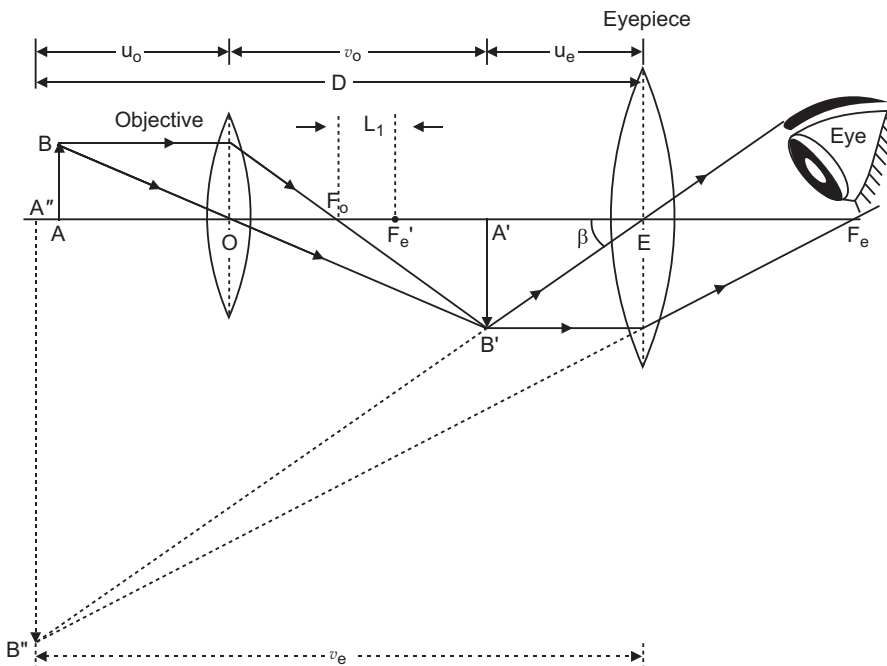

Magnifying power of microscope,

$$M = \frac{v_o}{u_o} \left(1 + \frac{D}{f_e} \right)$$

Given $u_0 = 1.5 \text{ cm}$, $f_0 = 125 \text{ cm}$, $f_e = 5 \text{ cm}$, $D = 25 \text{ cm}$

Formula $\frac{1}{f_0} = \frac{1}{v_0} + \frac{1}{u_0}$ gives

$$\frac{1}{1.25} = \frac{1}{v_0} + \frac{1}{1.5}$$

$$M = \frac{7.5}{1.5} = 5 \quad \frac{25}{5} = 5 \quad \text{30}$$

30. (a) Formation of depletion layer and potential barrier:

At the junction there is diffusion of charge carriers due to thermal agitation; so that some of electrons of n -region diffuse to p -region while some of holes of p -region diffuse into n -region. Some charge carriers combine with opposite charges to neutralise each other. Thus near the junction there is an excess of positively charged ions in n -region and an excess of negatively charged ions in p -region. This sets up a **potential difference** called potential barrier and hence an internal electric field E_i across the junctions. The field E_i is directed from n -region to p -region. This field stops the further diffusion of charge carriers. Thus the layers (10^{-4} cm to 10^{-6} cm) on either side of the junction becomes free from mobile charge carriers and hence is called the *depletion layer*. The symbol of p - n junction diode is shown in Fig.

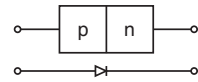
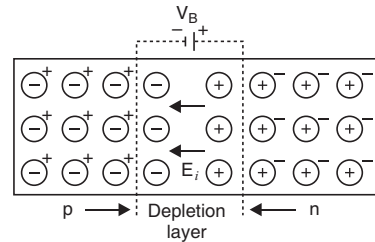

(b) The box contains the circuit of full wave rectifier.

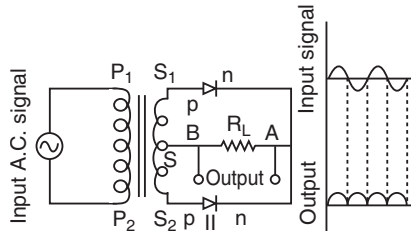

(c) Logic gate is AND gate. Its truth table is

A	B	Y
0	0	0
1	0	0
0	1	0
1	1	1

OR

(a) **Principle:** An oscillator converts dc into ac. A fraction of output voltage or current is fed back to the input circuit in the same phase as the input signal and the oscillations produced in LC circuit are amplified.

(b) If the valence and conduction bands overlap, the substance is referred as a *conductor*.

If the valence and conduction bands have a forbidden gap more than 3 eV, the substance is an insulator.

If the valence and conduction bands have a small forbidden gap (1 eV), the substance is a semiconductor.

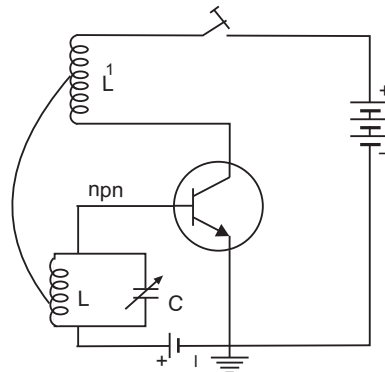

CBSE (Delhi) SET-II

3. Radius of *n*th orbit of hydrogen atom

$$r_n = \frac{0h^2 n^2}{me^2}$$

For inner most orbit *n* = 1

$$\frac{0h^2 (1)^2}{me^2}$$

For second excited state *n* = 3

$$r_3 = \frac{0h^2 (3)^2}{me^2}$$

$$\frac{r_3}{r_1} = 9 \quad r_3 = 9r_1 = 9 \times 5.3 \times 10^{-11} \text{ m} = 3.77 \times 10^{-10} \text{ m}$$

6. Ozone layer absorbs **ultraviolet rays**.

9. (i) For larger deflection to coil *P* should be moved at a **faster rate**.

(ii) **Faraday law:** The induced emf is directly proportional to rate of change of magnetic flux linked with the circuit.

10. 76–890 MHz.

Speed of waves is same for TV waves and light waves.

11. $\frac{1}{f} = (n - 1) \left(\frac{1}{R_1} + \frac{1}{R_2} \right)$

For biconvex lens $R_1 = R, R_2 = -R$

Given $f = \frac{2}{3}R$

$$\frac{3}{2R} = (n - 1) \frac{2}{R} \quad (n - 1) \frac{3}{4} = n - 1 \quad n - 1 = \frac{3}{4} \quad n = 1 + \frac{3}{4} = \frac{7}{4}$$

14. (i) The light is scattered by air molecules. According to Lord Rayleigh the intensity of scattered light

$$I \propto \frac{1}{(\text{wavelength})^4} \quad I \propto \frac{1}{\lambda^4}$$

As *blue* *red*, accordingly blue colour is scattered the most and red the least, so sky appears **blue**.

At the time of sunrise and sunset, blue colour is scattered the most and red colour enters our eyes, so sunrise and sunset appear red.

- (ii) Refractive index of prism material is maximum for violet and minimum for red colour.

17.
$$\frac{h}{\sqrt{2meV}} = \frac{6.63 \times 10^{-34}}{\sqrt{2 \times 9.1 \times 10^{-31} \times 1.6 \times 10^{19} \times 144}} \quad \lambda = 1 \times 10^{-10} \text{ m} = \mathbf{1 \text{ \AA}}$$

This corresponds to X-rays.

19. (i) The charge $Q = CV$, V same, C increases; there, charge on plates increases.
 (ii) A electric field $E = \frac{V}{d}$, and V constant, d constant; therefore, electric field strength remains the same.
 (iii) The capacitance of capacitor increases as $K > 1$.
20. (i) The line of sight (LOS) mode is limited to frequencies above 40 MHz, because at these frequencies antennas are relatively smaller and can be placed at heights of many wavelengths above the ground. Because of LOS mode direct waves get blocked by the curvature of earth. For receiving signals beyond horizon, the receiving antenna must be very high to intercept the LOS wave.

- (ii) Maximum LOS distance

$$d_m = \sqrt{2R_e h_T} + \sqrt{2R_e h_R}$$

Given $h_T = 32 \text{ m}$, $h_R = 50 \text{ m}$; $R_e = 6.4 \times 10^6 \text{ m}$

$$d_m = \sqrt{2 \times 6.4 \times 10^6 \times 32} + \sqrt{2 \times 6.4 \times 10^6 \times 50}$$

$$= 8 \times 10^3 \sqrt{6.4 \times 10} + 10 \times 10^3 \sqrt{6.4 \times 10}$$

$$= 18 \times 10^3 \sqrt{6.4 \times 10} + 18 \times 10^3 \sqrt{6.4 \times 10}$$

$$= 45.5 \times 10^3 \text{ m} = \mathbf{45.5 \text{ km}}$$

22.
$$\frac{R}{S} = \frac{l}{(100 - l)}$$

Given balancing length $l = 60.0 \text{ cm}$.

$$\frac{R}{S} = \frac{60}{40} = \frac{R}{S} = \frac{3}{2} \quad \dots(i)$$

When a resistance of 5Ω is connected in series with S , $l = 50 \text{ cm}$

$$\frac{R}{S + 5} = \frac{50}{100 - 50} = \frac{R}{S + 5} = 1$$

or $R = S = 5$... (ii)
 Solving (i) and (ii)
 $R = 15, S = 10$

CBSE (Delhi) SET-III

4. Microwaves are used in operating a RADAR.

5. $n = \frac{1}{\sin C} = \frac{1}{\sin 30} = 2$

Speed of light in medium $v = \frac{c}{n} = \frac{3 \times 10^8}{2} = 1.5 \times 10^8 \text{ m/s}$

$1.5 \times 10^8 \text{ m/s}$

7. Bohr's radius, $r_1 = \frac{0.529 \times 10^{-10} \text{ m}}{n^2}$

11. Range of frequencies used for satellite communication

5.925 – 6.425 GHz (Uplink)

3.7 – 4.2 GHz (Downlink)

Speed of wave is same for these waves and light waves.

12. (a) The bulb *B* lights due to induced current in coil *Q* because of change in magnetic flux linked with it on a consequence of continuous variation of magnitude of alternating current flowing in *P*.

(b) When coil *Q* moves towards left the rate of change of magnetic flux linked with *Q* decreases and so lesser current is induced in *Q*.

13. For a plano-convex lens $R_1 = \infty, R_2 = R$

$$\frac{1}{f} = (n - 1) \left(\frac{1}{R_1} - \frac{1}{R_2} \right) \text{ gives}$$

$$\frac{1}{f} = (n - 1) \left(\frac{1}{\infty} - \frac{1}{R} \right)$$

or $\frac{1}{f} = \frac{n - 1}{R} \Rightarrow R = (n - 1)f$

Given $f = 0.3 \text{ m}, n = 1.5$

$$R = (1.5 - 1) \times 0.3 \text{ m} = 0.15 \text{ m} = 15 \text{ cm}$$

14. de-Broglie wavelength

$$\lambda = \frac{h}{\sqrt{2meV}} = \frac{6.626 \times 10^{-34}}{\sqrt{2 \times 9.1 \times 10^{-31} \times 1.6 \times 10^{-19} \times V}}$$

$$= \frac{12.27}{\sqrt{V}} \times 10^{-10} \text{ m} = \frac{12.27}{\sqrt{V}} \text{ \AA}$$

Here $V = 64 \text{ V}$

$$\frac{12\ 27}{\sqrt{64}} \text{ \AA} \quad \frac{12\ 27}{8} \text{ \AA} \quad 1\ 53 \text{ \AA}$$

This corresponds to **X-ray region** of *em* spectrum.

15. (i) By a prism blue light is deviated more than red light; because deviation

$$(n - 1) A$$

refractive index n is more for blue than red light.

- (ii) Refractive index

$$n = \frac{\sin \frac{A + m}{2}}{\sin \frac{A}{2}}$$

where A = angle of prism

m = angle of minimum deviation.

20. In first case

$$\frac{R}{S} = \frac{l_1}{100 - l_1} \quad \dots(i)$$

When X and S are in parallel, let resistance

$$S = \frac{XS}{X + S}$$

In second case
$$\frac{R}{\frac{XS}{X + S}} = \frac{l_2}{100 - l_2} \quad \dots(ii)$$

Dividing (ii) by (i), we get

$$\frac{X + S}{X} \cdot \frac{l_1}{l_2} = \frac{100 - l_1}{100 - l_2} \quad X = \frac{S}{\frac{l_2}{l_1} \cdot \frac{100 - l_1}{100 - l_2} - 1}$$

27. (i) No change, $\therefore E = \frac{q}{0} \text{ or } \frac{q}{0A}$

(ii) Halved, $\therefore C = \frac{0A}{d} \text{ or } C = \frac{1}{d}$

(iii) Doubled, $\therefore W = \frac{Q^2}{2C} \text{ or } W = \frac{1}{C}$

CBSE EXAMINATION PAPERS

ALL INDIA-2010

Time allowed: 3 hours

Maximum marks: 70

General Instructions:

- All questions are compulsory.
- There are 30 questions in total. Questions 1 to 8 carry one mark each, questions 9 to 18 carry two marks each, questions 19 to 27 carry three marks each and questions 28 to 30 carry five marks each.
- There is no overall choice. However, an internal choice has been provided in one question of two marks, one question of three marks and all three questions of five marks each. You have to attempt only one of the given choices in such questions.
- Use of calculators is not permitted.
- You may use the following values of physical constants wherever necessary:

$$c = 3 \times 10^8 \text{ ms}^{-1} \quad h = 6.626 \times 10^{-34} \text{ Js}$$
$$e = 1.602 \times 10^{-19} \text{ C} \quad \mu_0 = 4\pi \times 10^{-7} \text{ TmA}^{-1}$$
$$\frac{1}{4\pi\epsilon_0} = 9 \times 10^9 \text{ Nm}^2\text{C}^{-2}$$

$$\text{Boltzmann's constant } k = 1.381 \times 10^{-23} \text{ JK}^{-1}$$

$$\text{Avogadro's number } N_A = 6.022 \times 10^{23} / \text{mole}$$

$$\text{Mass of neutron } m_n = 1.675 \times 10^{-27} \text{ kg}$$

$$\text{Mass of electron } m_e = 9.1 \times 10^{-31} \text{ kg}$$

$$\text{Radius of earth} = 6400 \text{ km}$$

CBSE (All India) SET-I

- Name the physical quantity whose S.I. unit is JC^{-1} . Is it a scalar or a vector quantity?
- A beam of α particles projected along +x-axis, experiences a force due to a magnetic field along the +y-axis. What is the direction of the magnetic field?

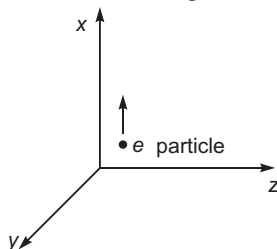

- Define self-inductance of a coil. Write its SI units.
- A converging lens is kept co-axially in contact with a diverging lens – both the lenses being of equal focal lengths. What is the focal length of the combination?
- Define ionisation energy. What is its value for a hydrogen atom?

6. Two conducting wires X and Y of same diameter but different materials are joined in series across a battery. If the number density of electrons in X is twice that in Y , find the ratio of drift velocity of electrons in the two wires.
7. Name the part of electromagnetic spectrum whose wavelength lies in the range of 10^{-10} m. Give its one use.
8. When light travels from a rarer to a denser medium, the speed decreases. Does this decrease in speed imply a decrease in the energy carried by the light wave? Justify your answer.
9. Deduce the expression for the magnetic dipole moment of an electron orbiting around the central nucleus.
10. A spherical conducting shell of inner radius r_1 and outer radius r_2 has a charge ' Q '. A charge ' q ' is placed at the centre of the shell.
 - (a) What is the surface charge density on the (i) inner surface, (ii) outer surface of the shell?
 - (b) Write the expression for the electric field at a point $x < r_2$ from the centre of the shell.
11. Draw a sketch of a plane electromagnetic wave propagating along the z -direction. Depict clearly the directions of electric and magnetic fields varying sinusoidally with z .
12. Show that the electric field at the surface of a charged conductor is given by $E = \frac{\sigma}{\epsilon_0} \hat{n}$, where σ is the surface charge density and \hat{n} is a unit vector normal to the surface in the outward direction.
13. Two identical loops, one of copper and the other of aluminium, are rotated with the same angular speed in the same magnetic field. Compare (i) the induced emf and (ii) the current produced in the two coils. Justify your answer.
14. An α -particle and a proton are accelerated from rest by the same potential. Find the ratio of their de-Broglie wavelengths.
15. Write two factors justifying the need of modulating a signal.
A carrier wave of peak voltage 12 V is used to transmit a message signal. What should be the peak voltage of the modulating signal in order to have a modulation index of 75%?
16. Write Einstein's photoelectric equation. State clearly the three salient features observed in photoelectric effect, which can be explained on the basis of the above equation.
17. Draw a plot of potential energy of a pair of nucleons as a function of their separation. Write two important conclusions which you can draw regarding the nature of nuclear forces.

OR

Draw a plot of the binding energy per nucleon as a function of mass number for a large number of nuclei, $2 \leq A \leq 240$. How do you explain the constancy of binding energy per nucleon in the range $30 \leq A \leq 170$ using the property that nuclear force is short-ranged?

Nuclear forces are short ranged, so every nucleon interacts with their neighbours only; so binding energy per nucleon remains constant.]

18. (i) Identify the logic gates marked P and Q in the given logic circuit.

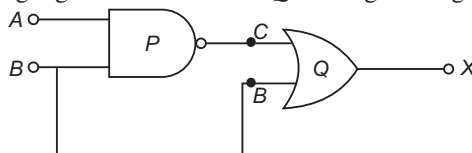

- (ii) Write down the output at X for the inputs $A = 0, B = 0$ and $A = 1, B = 1$.

19. Which mode of propagation is used by short wave broadcast services having frequencies range from a few MHz upto 30 MHz? Explain diagrammatically how long distance communication can be achieved by this mode. Why is there an upper limit to frequency of waves used in this mode?

20. Write any two factors on which internal resistance of a cell depends. The reading on a high resistance voltmeter, when a cell is connected across it, is 2.2 V. When the terminals of the cell are also connected to a resistance of 5 Ω as shown in the circuit, the voltmeter reading drops to 1.8 V. Find the internal resistance of the cell.

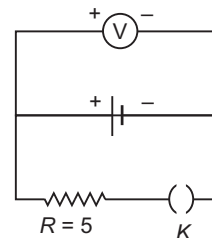

21. A network of four capacitors each of 12 μF capacitance is connected to a 500 V supply as shown in the figure. Determine (a) equivalent capacitance of the network and (b) charge on each capacitor.

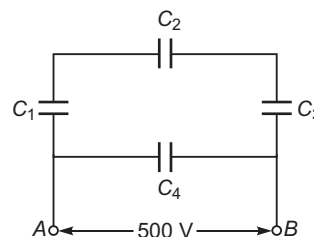

22. (i) Draw a neat labelled ray diagram of an astronomical telescope in normal adjustment. Explain briefly its working.
 (ii) An astronomical telescope uses two lenses of powers 10 D and 1 D. What is its magnifying power in normal adjustment?

OR

(i) Draw a neat labelled ray diagram of a compound microscope. Explain briefly its working.
 (ii) Why must both the objective and the eye-piece of a compound microscope have short focal lengths?

23. In Young's double slit experiment, the two slits 0.15 mm apart are illuminated by monochromatic light of wavelength 450 nm. The screen is 1.0 m away from the slits.
 (a) Find the distance of the second (i) bright fringe, (ii) dark fringe from the central maximum.
 (b) How will the fringe pattern change if the screen is moved away from the slits?

24. State Kirchhoff's rules. Use these rules to write the expressions for the currents I_1 , I_2 and I_3 in the circuit diagram shown.

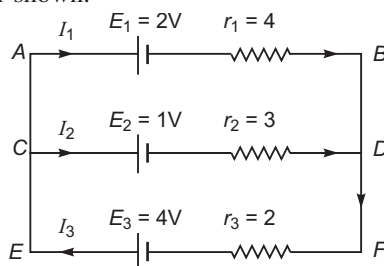

25. (a) Write symbolically the decay process of ${}_{15}^{32}\text{P}$.
 (b) Derive an expression for the average life of a radionuclide. Give its relationship with the half-life.
26. How does an unpolarised light get polarised when passed through polaroid?
 Two polaroids are set in crossed positions. A third polaroid is placed between the two making an angle with the pass axis of the first polaroid. Write the expression of the intensity of light transmitted from the second polaroid. In what orientations will the transmitted intensity be (i) minimum and (ii) maximum?
27. An illuminated object and a screen are placed 90 cm apart. Determine the focal length and nature of the lens required to produce a clear image on the screen, twice the size of the object.
28. (a) With the help of a diagram, explain the principle and working of a moving coil galvanometer.
 (b) What is the importance of a radial magnetic field and how is it produced
 (c) Why is it that while using a moving coil galvanometer as a voltmeter a high resistance in series is required whereas in an ammeter a shunt is used?

OR

- (a) Derive an expression for the force between two long parallel current carrying conductors.
 (b) Use this expression to define S. I. unit of current.
 (c) A long straight wire AB carries a current I . A proton P travels with a speed v , parallel to the wire, at a distance d from it in a direction opposite to the current as shown in the figure. What is the force experienced by the proton and what is its direction?

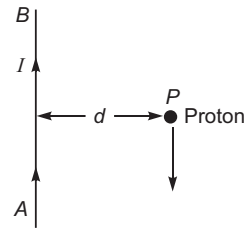

29. State Faraday's law of electromagnetic induction.

Figure shows a rectangular conductor $PQRS$ in which the conductor PQ is free to move in a uniform magnetic field B perpendicular to the plane of the paper. The field extends from $x = 0$ to $x = b$ and is zero for $x > b$. Assume that only the arm PQ possesses resistance r . When the arm PQ is pulled outward from $x = 0$ to $x = 2b$ and is then moved backward to $x = 0$ with constant speed v , obtain the expressions for the flux and the induced emf. Sketch the variations of these quantities with distance $0 < x < 2b$.

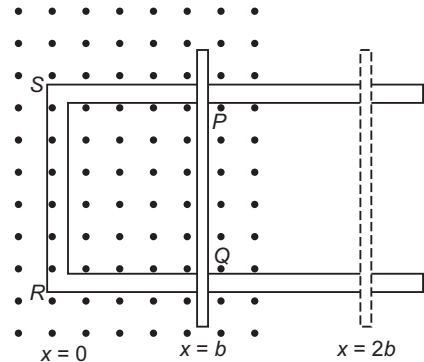

OR

Draw a schematic diagram of a step-up transformer. Explain its working principle. Deduce the expression for the secondary to primary voltage in terms of the number of turns in the two coils. In an ideal transformer, how is this ratio related to the currents in the two coils?
 How is the transformer used in large scale transmission and distribution of electrical energy over long distances?

30. (a) Draw the circuit diagrams of a $p-n$ junction diode in (i) forward bias, (ii) reverse bias. How are these circuits used to study the $V-I$ characteristics of a silicon diode? Draw the typical $V-I$ characteristics?
- (b) What is a light emitting diode (LED)? Mention two important advantages of LEDs over conventional lamps.

OR

- (a) Draw the circuit arrangement for studying the input and output characteristics of an $n-p-n$ transistor in CE configuration. With the help of these characteristics define (i) input resistance, (ii) current amplification factor.
- (b) Describe briefly with the help of a circuit diagram how an $n-p-n$ transistor is used to produce self-sustained oscillations.

CBSE (All India) SET-II

Questions uncommon to Set-I

1. Find the ratio of energies of photons produced due to transition of an electron of hydrogen atom from its:
- (i) second permitted energy level to the first level, and
- (ii) the highest permitted energy level to the first permitted level.

4. A beam of electrons projected along $+X$ axis, experiences a force due to a magnetic field along the y -axis. What is the direction of the magnetic field?

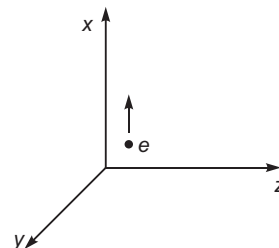

5. Which of the following has the shortest wavelength:
Microwaves, Ultraviolet rays, X-rays

12. A rectangular loop and a circular loop are moving out of a uniform magnetic field to a field-free region with a constant velocity ' v ' as shown in the figure. Explain in which loop do you expect the induced emf to be constant during the passage out of the field region. The magnetic field is normal to the loops.

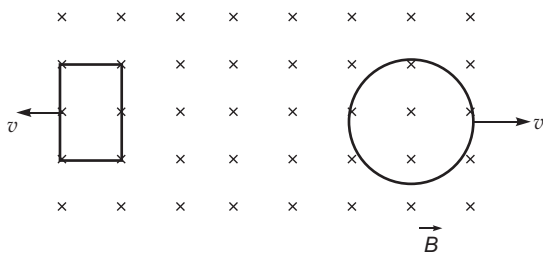

19. A network of four capacitors each of 15 F capacitance is connected to a 500 V supply as shown in the figure. Determine (a) equivalent capacitance of the network and (b) charge on each capacitor.

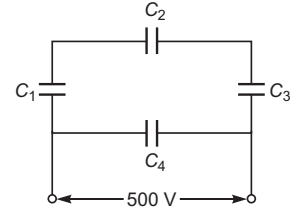

20. Write any two factors on which internal resistance of a cell depends. The reading on a high resistance voltmeter, when a cell is connected across it, is 2.0 V . When the terminals of the cell are also connected to a resistance of $3 \text{ } \Omega$ as shown in the circuit, the voltmeter reading drops to 1.5 V . Find the internal resistance of the cell.

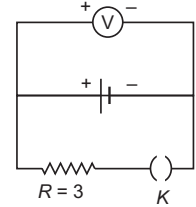

22. In Young's double slit experiment, the two slits 0.12 mm apart are illuminated by monochromatic light of wavelength 420 nm . The screen is 1.0 m away from this slits.
- Find the distance of the second (i) bright fringe, (ii) dark fringe from the central maximum.
 - How will the fringe pattern change if the screen is moved away from this slits?
23. State Kirchhoff's rules. Apply Kirchhoff's rules to the loops $ACBPA$ and $ACBQA$ to write the expressions for the currents I_1 , I_2 and I_3 in the network.

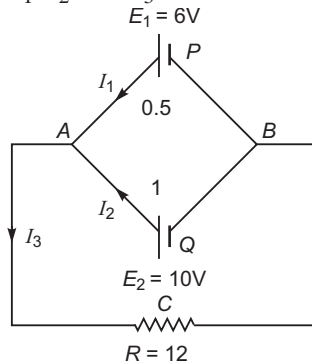

27. The image obtained with a convex lens is erect and its length is four times the length of the object. If the focal length of the lens is 20 cm , calculate the object and image distances.

CBSE (All India) SET-III

Questions uncommon to Set-I and Set-II

- Arrange the following in descending order of wavelength:
X-rays, Radio waves, Blue light, Infrared light
- The ground state energy of hydrogen atom is -13.6 eV . What are the kinetic and potential energies of electron in this state?

21. A convex lens is used to obtain a magnified image of an object on a screen 10 m from the lens. If the magnification is 19, find the focal length of the lens.
24. Write any two factors on which internal resistance of a cell depends. The reading on a high resistance voltmeter, when a cell is connected across it, is 2.5 V. When the terminals of the cell are also connected to a resistance of 5 Ω are shown in the circuit, the voltmeter reading drops to 2.0 V. Find the internal resistance of the cell.

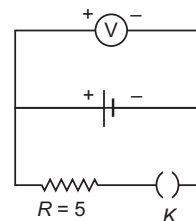

25. In Young's double slit experiment, the two slits 0.20 mm apart are illuminated by monochromatic light of wavelength 600 nm. The screen is 1.0 m away from the slits.
- (a) Find the distance of the second (i) bright fringe, (ii) dark fringe from the central maximum.
- (b) How will the fringe pattern change if the screen is moved away from the slits?
26. State Kirchhoff's rules. Apply these rules to the loops *PRSP* and *PRQP* to write the expressions for the currents I_1 , I_2 and I_3 in the given circuit.

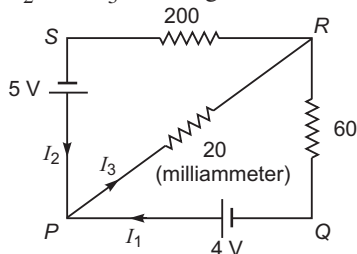

Solutions

CBSE (AI) Set-I

- Electric potential. It is a scalar quantity.
- By Fleming's left hand rule magnetic field must be along negative Z-axis
- The self inductance is defined on the magnetic flux linked with the coil when unit current flows through it.

Or

The self inductance is defined as the emf induced in the coil, when the rate of change of current in the coil is 1 ampere/second.

The unit of self-inductance is henry (H).

- Let focal length of converging and diverging lenses be f_1 and f_2 respectively.

Power of converging lens $P_1 = \frac{1}{f_1}$, Power of diverging lens $P_2 = -\frac{1}{f_2}$

$$\text{Power of combination } P = P_1 + P_2 = \frac{1}{f_1} - \frac{1}{f_2} = 0$$

$$\text{Focal length of combination } F = \frac{1}{\frac{1}{P} + \frac{1}{0}} \quad (\text{infinite})$$

$F = \infty$

- The minimum energy required to remove an electron from atom to infinitely far away is called the **ionisation energy**. The ionisation energy for hydrogen atom is 13.6 eV.
- In series current is same $i_X = i_Y$.

For same diameter, cross-sectional area is same.

$$\frac{n_x e A v_x}{v_y} = \frac{n_y e A v_y}{2 n_y \frac{1}{2}} \quad v_x : v_y = 1 : 2$$

- X-ray; used to study crystal structure
- No; when light travels from a rarer to denser medium, its frequency remains unchanged. According to quantum theory, the energy of a light beam depends on frequency and not on speed
- Consider an electron revolving around a nucleus (N) in circular path of radius r with speed v . The revolving electron is equivalent to electric current

$$I = \frac{e}{T}$$

where T is period of revolution $\frac{2\pi r}{v}$

$$I = \frac{e}{2\pi r/v} = \frac{ev}{2\pi r}$$

Area of current loop (electron orbit), $A = \pi r^2$

Magnetic moment due to orbital motion,

$$M_l = IA = \frac{ev}{2\pi r} (\pi r^2) = \frac{evr}{2}$$

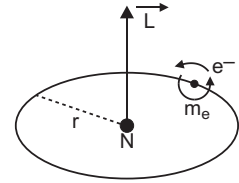

- Charge Q resides on outer surface of spherical conducting shell. Due to charge q placed at centre, charge induced on inner surface is $-q$ and on outer surface it is q . So, total charge on inner surface q and on outer surface it is $Q + q$.

Surface charge density on inner surface $\frac{q}{4\pi r_1^2}$

Surface charge density on outer surface $\frac{Q + q}{4\pi r_2^2}$

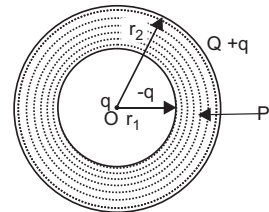

- For external points, whole charge acts at centre, so electric field at distance $x = r_2$,

$$E(x) = \frac{1}{4\pi\epsilon_0} \frac{Q + q}{x^2}$$

11. Electric field is along x-axis and magnetic field is along y-axis

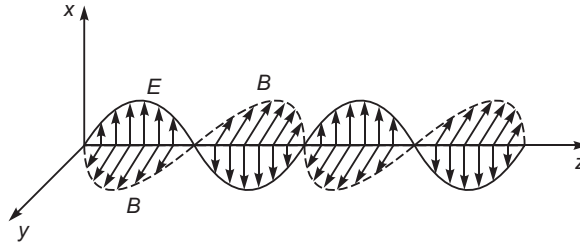

12. Let a charge Q be given to a conductor, this charge under electrostatic equilibrium will redistribute and the electric field inside the conductor is zero (i.e., $E_{in} = 0$).

Let us consider a point P at which electric field strength is to be calculated, just outside the surface of the conductor. Let the surface charge density on the surface of the conductor in the neighbourhood of P be coulomb/metre². Now consider a small cylindrical box CD having one base C passing through P ; the other base D lying inside the conductor and the curved surface being perpendicular to the surface of the conductor.

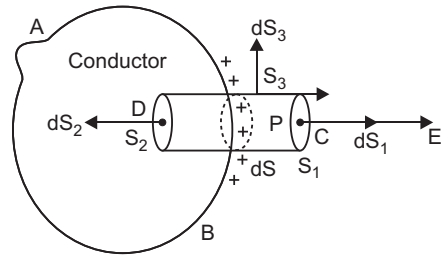

Let the area of each flat base be a . As the surface of the conductor is equipotential surface, the electric field strength E at P , just outside the surface of the conductor is perpendicular to the surface of the conductor in the neighbourhood of P .

The flux of electric field through the curved surface of the box is zero, since there is no component of electric field E normal to curved surface. Also the flux of electric field through the base D is zero, as electric field strength inside the conductor is zero. Therefore the resultant flux of electric field through the entire surface of the box is same as the flux through the face C . This may be analytically seen as:

If S_1 and S_2 are flat surfaces at C and D and S_3 is curved surface, then

$$\begin{aligned} \text{Total electric flux} &= \oint_S E \cdot dS = \int_{S_1} E \cdot dS + \int_{S_2} E \cdot dS + \int_{S_3} E \cdot dS \\ &= \int_{S_1} E \, dS_1 \cos 0 + \int_{S_2} 0 \, dS_2 + \int_{S_3} E \, dS_3 \cos 90 \\ &= \int_S E \, dS_1 = E a \end{aligned}$$

As the charge enclosed by the cylinder is (a) coulomb, we have, using Gauss's theorem,

$$\begin{aligned} \text{Total electric flux} &= \frac{1}{\epsilon_0} \text{ charge enclosed} \\ E a &= \frac{1}{\epsilon_0} (a) \quad \text{or} \quad \boxed{E = \frac{\sigma}{\epsilon_0}} \quad \dots(i) \end{aligned}$$

Thus **the electric field strength at any point close to the surface of a charged conductor of any shape is equal to $1/\epsilon_0$ times the surface charge density**. This is known as *Coulomb's law*. The electric field strength is directed radially away from the conductor if σ is positive and towards the conductor if σ is negative.

If \hat{n} is unit vector normal to surface in outward direction, then

$$E = \frac{\sigma}{\epsilon_0} \hat{n}$$

Obviously electric field strength near a plane conductor is twice of the electric field strength near a non-conducting thin sheet of charge.

13. (i) Induced emf
$$\frac{d}{dt} \int \vec{B} \cdot d\vec{A} = \frac{d}{dt} (BA \cos \theta)$$

$$= BA \sin \theta \frac{d\theta}{dt}$$

As $B, A,$ are same for both loops so induced emf is same for both loops.

(ii) Current induced
$$I = \frac{\text{emf}}{R}$$

As resistance R is less for copper loop, so current induced is larger in copper loop.

14. de Broglie wave length
$$\lambda = \frac{h}{\sqrt{2mE}} = \frac{h}{\sqrt{2mqV}}$$

For α -particle,

$$\lambda_{\alpha} = \frac{h}{\sqrt{2m_{\alpha} q_{\alpha} V}}$$

For proton,

$$\lambda_p = \frac{h}{\sqrt{2m_p q_p V}}$$

But $\frac{m}{m_p} = 4, \frac{q}{q_p} = 2$

$$\frac{\lambda_{\alpha}}{\lambda_p} = \sqrt{\frac{1}{4} \cdot \frac{1}{2}} = \frac{1}{2\sqrt{2}}$$

15. The modulation is needed due to

- (i) Transmission of audio frequency electrical signals need long impracticable antenna.
- (ii) The power radiated at audio frequency is quite small, hence transmission is quite lossy.
- (iii) The various information signals transmitted at low frequency get mixed and hence can not be distinguished.

Modulation index,

$$m_a = \frac{E_m}{E_c}$$

Peak voltage of modulating signal,

$$E_m = m_a E_c = \frac{75}{100} \times 12 = 9 \text{ V}$$

16. Einstein's photoelectric equation is $E_k = h\nu - W$ for a single photon ejecting a single electron.

- (i) **Explanation of frequency law:** When frequency of incident photon (ν), increases, the kinetic energy of emitted electron increases. Intensity has no effect on kinetic energy of photoelectrons.

- (ii) **Explanation of intensity law:** When intensity of incident light increases, the number of incident photons increases, as one photon ejects one electron; the increase in intensity will increase the number of ejected electrons. In other words, photocurrent will increase with increase of intensity. Frequency has no effect on photocurrent.
- (iii) **Explanation of no time lag law:** When the energy of incident photon is greater than work function, the photoelectron is immediately ejected. Thus there is no time lag between incidence of light and emission of photoelectrons.

17. Part *AB* represents repulsive force and Part *BCD* represents attractive force.

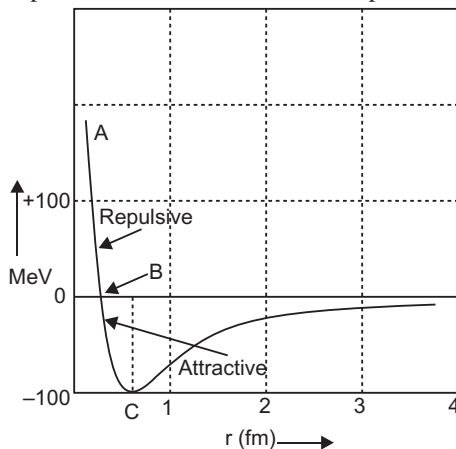

Conclusions:

- (i) Nuclear forces are attractive and stronger, than electrostatic force.
- (ii) Nuclear forces are charge-independent.

OR

The variation of binding energy per nucleon versus mass number is shown in figure.

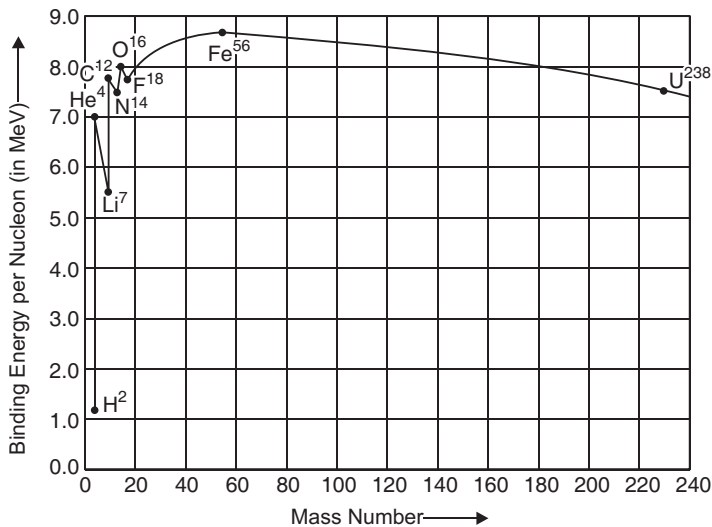

Since nuclear forces are short-ranged, every nucleon interacts with their neighbours only. Therefore, binding energy per nucleon remains constant.

18. (i) P is 'NAND' gate and Q is 'OR' gate.

(ii) $C = \overline{A \cdot B} \quad X = C \cdot B \quad \overline{A \cdot B} \cdot B$

When $A = 0, B = 0, C = \overline{A \cdot B} = \overline{0 \cdot 0} = 1$

$X = 1 \cdot 0 = 0$

When $A = 1, B = 1$

$C = \overline{A \cdot B} = \overline{1 \cdot 1} = \overline{1} = 0$

$X = 0 \cdot 1 = 0$

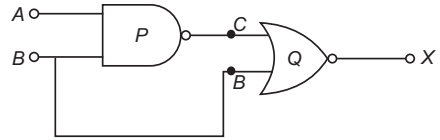

19. The mode of propagation used by short wave broadcast services having frequency range from a few MHz upto 30 MHz is **sky wave propagation**.

The diagram is shown in fig.

There is an upper limit of frequency because for frequency higher than 30 MHz the radiowaves penetrate through the ionosphere and escape.

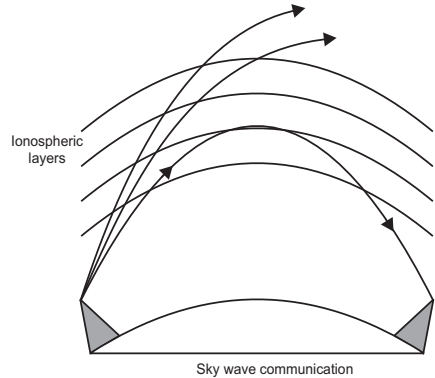

20. The internal resistance of a cell depends on

- (i) distance (l) between electrodes.
- (ii) area (A) of immersed part of electrode, and
- (iii) nature and concentration of electrolyte.

Given, $E = 2.3 \text{ V}, V = 1.8 \text{ V}, R = 5$

$$r = \frac{E}{V} - R$$

$$r = \frac{2.3}{1.8} - 5 = \frac{10}{9} \quad \mathbf{11}$$

21. (a) C_1, C_2 and C_3 are in series, their equivalent capacitance C is given by

$$\frac{1}{C} = \frac{1}{C_1} + \frac{1}{C_2} + \frac{1}{C_3}$$

$$\frac{1}{12} = \frac{1}{12} + \frac{1}{12}$$

$$C = 4 \text{ F}$$

C_4 is in parallel with C , so equivalent capacitance of network

$$C_{eq} = C + C_4 = 4 + 16 = 20 \text{ F}$$

- (b) Charge on capacitor C_4 is

$$q_4 = C_4 V = (16 \text{ F}) (500 \text{ V}) = 8000 \text{ C} = 8 \text{ mC}$$

22. (i) **Working:** Suppose AB is the point object whose end A is on the axis of telescope. The objective lens (L_1) forms image $A'B'$ of object AB at the second principal focus F_0 . The image $A'B'$ is real, inverted and diminished. For normal adjustment position this image also lies at first focus (F_e) of eye lens (L_2). This image acts as an object for eye lens and final image is formed at infinity. The final image $A''B''$ (say), is magnified and inverted.

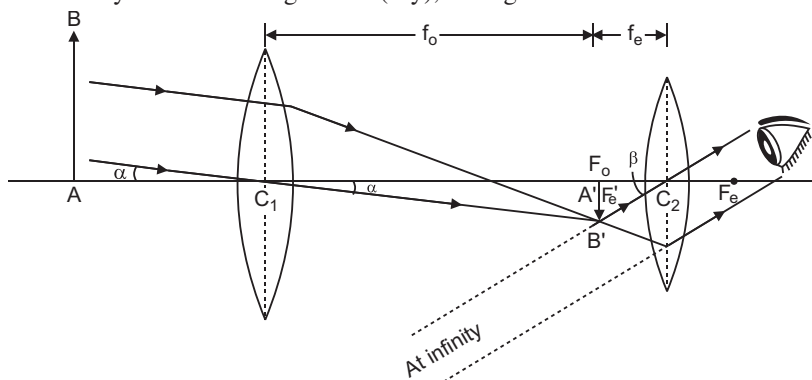

(ii) $M = \frac{f_0}{f_e} = \frac{P_e}{P_0} = \frac{10 \text{ D}}{1 \text{ D}} = 10$

OR

(i)

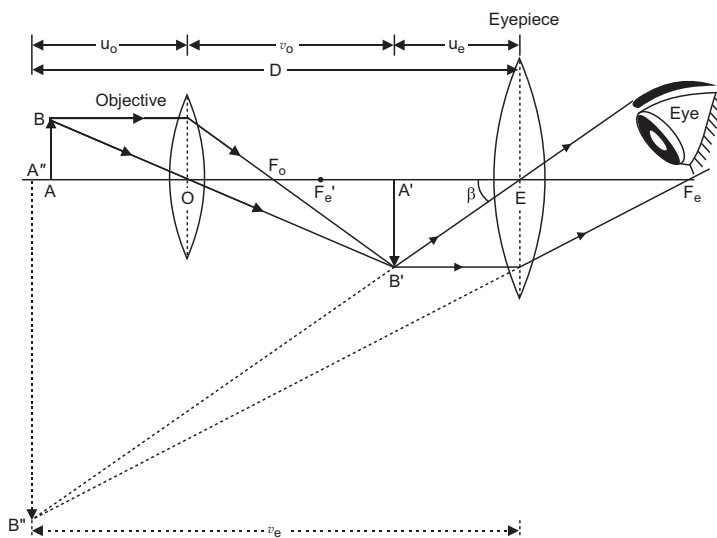

Working: Suppose a small object AB is placed slightly away from the first focus F_0 of the objective lens. The objective lens forms the real, inverted and magnified image $A'B'$, which acts as an object for eyepiece. The eyepiece is so adjusted that the image $A'B'$ lies between the first focus F_e and the eyepiece E . The eyepiece forms its image $A''B''$ which is virtual, erect and magnified. Thus the final image $A''B''$ formed by the microscope is inverted and magnified and its position is outside the objective and eyepiece towards objective lens. Magnifying power of compound microscope is

$$M = \frac{v_0}{u_0} = 1 + \frac{D}{b_e} \quad \text{for final image at distance of distinct vision}$$

$$\frac{L}{f_0} = 1 + \frac{D}{f_e}$$

$$M = \frac{v_0}{u_0} \frac{D}{f_e} = \frac{L}{f_0} \frac{D}{f_e} \quad \text{for final image at infinity}$$

(ii) For large magnifying power, f_0 and f_e both have to be small.

- 23.** Given $d = 0.25 \text{ mm} = 0.15 \times 10^{-3} \text{ m}$,
 $\lambda = 450 \text{ nm} = 450 \times 10^{-9} \text{ m}$, $D = 1.0 \text{ m}$

(a) Distance of second bright maximum from central maximum ($n = 2$)

$$y_2 = \frac{nD}{d} = \frac{2 \times 1.0 \times 450 \times 10^{-9}}{0.15 \times 10^{-3}} \text{ m} = 6 \times 10^{-3} \text{ m} = \mathbf{6 \text{ mm}}$$

Distance of second dark fringe from central maximum ($n = 2$)

$$y_2 = n \frac{\lambda}{2} = 2 \times \frac{1}{2} \frac{450 \times 10^{-9}}{0.15 \times 10^{-3}} = 4.5 \times 10^{-3} \text{ m} = \mathbf{4.5 \text{ mm}}$$

(b) If screen is moved away from the slits, D increases, **so fringe width $\frac{D}{d}$ increases.**

24. Kirchhoff's Rules:

(i) The algebraic sum of currents meeting at any junction is zero, i.e.,

$$\sum I = 0$$

(ii) The algebraic sum of potential differences across circuit elements of a closed circuit is zero, i.e.,

$$\sum V = 0$$

From Kirchhoff's first law

$$I_3 - I_1 - I_2 = 0 \quad \dots(i)$$

For applying Kirchhoff's second law to mesh $ABDC$

$$2 - 4I_1 - 3I_2 - 1 = 0$$

$$4I_1 + 3I_2 = 1 \quad \dots(ii)$$

Applying Kirchhoff's II law to mesh $ABCEA$

$$2 - 4I_1 + 2I_3 - 4 = 0$$

$$4I_1 - 2I_3 = 2 \quad \text{or} \quad 2I_1 - I_3 = 1$$

Using (i) we get

$$2I_1 - (I_1 + I_2) = 1$$

or

$$3I_1 - I_2 = 1 \quad \dots(iii)$$

Solving (ii) and (iii), we get

$$I_1 = \frac{2}{3} \text{ A}, \quad I_2 = 1 - 3I_1 = \frac{7}{13} \text{ A}$$

so,

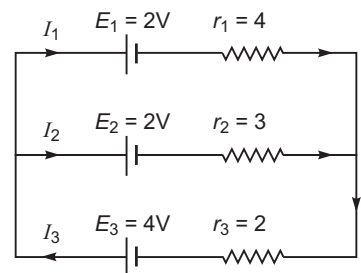
$$I_3 = I_1 + I_2 = \frac{9}{13} \text{ A}$$

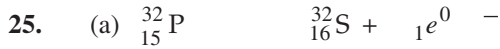

(b) If N_0 is the total number of nuclei at $t = 0$, then mean life time

$$\frac{\text{Total life time of all the nuclei}}{\text{Total number of nuclei}} = \frac{\int_0^{\infty} t \cdot dN}{N_0}$$

$$= \frac{\int_0^{\infty} t \cdot N dt}{N_0}$$

Also we have $N = N_0 e^{-\lambda t}$

$$\int_0^{\infty} t (N_0 e^{-\lambda t}) dt = N_0 \int_0^{\infty} t e^{-\lambda t} dt$$

As nuclei decay indefinitely, we may replace the summation into integration with limits from $t = 0$ to $t = \infty$ i.e.,

$$\int_0^{\infty} t e^{-\lambda t} dt.$$

Integrating by parts, we get

$$\left[\frac{t e^{-\lambda t}}{-\lambda} + \frac{1}{\lambda} e^{-\lambda t} \right]_0^{\infty}$$

$$= \left[\frac{1}{\lambda} e^{-\lambda t} \right]_0^{\infty}$$

$$= \frac{1}{\lambda} [0 - 1] = -\frac{1}{\lambda}$$

Thus, $\tau = \frac{1}{\lambda}$.

i.e., the mean life time of a radioactive element is reciprocal of its decay constant.

Relation Between Mean Life and Half Life

Half life $T_{1/2} = \frac{0.6931}{\lambda}$...*(i)*

Mean life $\tau = \frac{1}{\lambda}$...*(ii)*

Substituting value of λ from *(ii)* in *(i)*, we get

$$T_{1/2} = 0.6931 \tau$$

26. **Polaroid:** A polaroid consists of long chain molecules aligned in a particular direction. The electric vectors (associated with the propagating light wave) along the direction of the aligned molecules get absorbed. Thus, if an unpolarised light wave is incident on such a polaroid then the light wave will get linearly polarised with the electric vector oscillating along a direction perpendicular to the aligned molecules.

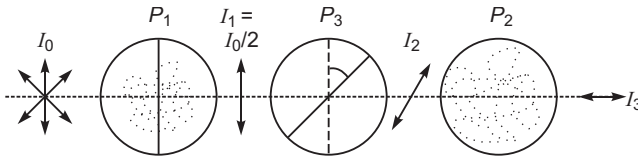

Let intensity of incident unpolarised light on first polaroid be I_0 .

Intensity of light transmitted through 1st polaroid P_1 is $I_1 = \frac{I_0}{2}$.

Intensity of light transmitted through polaroid P_3 is

$$I_2 = \frac{I_0}{2} \cos^2$$

Angle between pass-axis of P_3 and P_2 is $(90^\circ - \theta)$

Intensity of light transmitted through polaroid P_2 is

$$I_3 = I_2 \cos^2 (90^\circ - \theta) = \frac{I_0}{2} \cos^2 \theta \sin^2 \theta$$

$$= \frac{I_0}{8} (2 \cos \theta \sin \theta)^2 = \frac{I_0}{8} \sin^2 2\theta$$

(i) Intensity I_3 will be minimum, when

$$\sin 2\theta = 0 \quad \theta = 0^\circ$$

(ii) Intensity I_3 will be maximum when

$$\sin 2\theta = 1 \quad \theta = 45^\circ$$

27. Given $u = 30$ cm, $v = 60$ cm ... (i)

$$\frac{1}{f} = \frac{1}{u} + \frac{1}{v} \text{ gives}$$

$$\frac{1}{f} = \frac{1}{30} + \frac{1}{60}$$

or $|v| = 2|u|$ (numerically) ... (ii)

From (i) and (ii)

$$|u| = 30 \text{ cm}, |v| = 60 \text{ cm}$$

By sign convention $u = -30$ cm, $v = 60$ cm

$$\frac{1}{f} = \frac{1}{-30} + \frac{1}{60} \text{ gives}$$

$$\frac{1}{f} = \frac{1}{60} - \frac{1}{30} = \frac{1-2}{60}$$

$$f = -20 \text{ cm} \quad (\text{convex lens})$$

28. (a) **Principle and working:** When current (I) is passed in the coil, torque acts on the coil, given by

$$NIAB \sin \theta$$

where θ is the angle between the normal to plane of coil and the magnetic field of strength B , N is the number of turns in a coil.

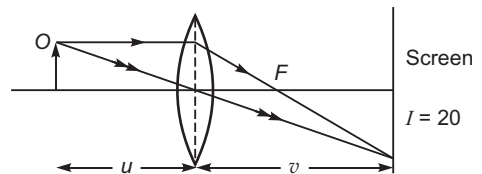

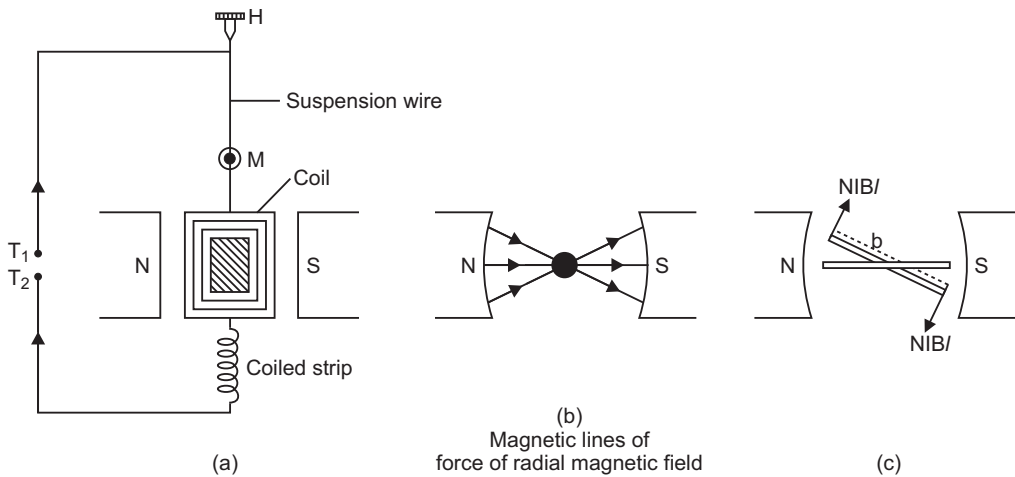

When the magnetic field is radial, as in the case of cylindrical pole pieces and soft iron core, then in every position of coil the plane of the coil, is parallel to the magnetic field lines, so that $\theta = 90^\circ$ and $\sin 90^\circ = 1$

Deflecting torque, $\tau = NIAB$

If C is the torsional rigidity of the wire and θ is the twist of suspension strip, then restoring torque $\tau = C\theta$

For equilibrium, deflecting torque = restoring torque

i.e. $NIAB = C\theta$

$$\theta = \frac{NAB}{C} I \quad \dots(i)$$

i.e. $\theta \propto I$

deflection of coil is directly proportional to current flowing in the coil and hence we can construct a linear scale.

(b) Importance (or function) of uniform radial magnetic field: In radial magnetic field $\sin \theta = 1$, so torque is $\tau = NIAB$. This makes the deflection (θ) proportional to current. In other words, the radial magnetic field makes the **scale linear**.

To produce radial magnetic field pole pieces of permanent magnet are made cylindrical and a soft iron core is placed between them. The soft iron core helps in making the field radial and reduce energy losses produced due to eddy currents.

(c) A voltmeter is used to measure p.d. across a resistance in an electrical circuit. It is connected in parallel across the resistance. If a voltmeter has very high resistance, it will not affect the resistance of circuit, hence reading will be true. That is why while using a moving coil galvanometer on a voltmeter, a high resistance in series is required.

An ammeter is used to measure current in circuit, hence it is connected in series with the circuit. If an ammeter has very low resistance it will not affect the circuit - resistance and so reading will be true. That is why while using a moving coil galvanometer as an ammeter, a shunt (small resistance in parallel) is used.

OR

- (a) Suppose two long thin straight conductors (or wires) PQ and RS are placed parallel to each other in vacuum (or air) carrying currents I_1 and I_2 respectively. It has been observed experimentally that when the currents in the wire are in the same direction, they experience an attractive force (fig. a) and when they carry currents in opposite directions, they experience a repulsive force (fig. b).

Let the conductors PQ and RS carry currents I_1 and I_2 in same direction and placed at separation r . (fig.).

Consider a current–element ‘ ab ’ of length L of wire RS . The magnetic field produced by current-carrying conductor PQ at the location of other wire RS

$$B_1 = \frac{\mu_0 I_1}{2 r} \dots(i)$$

According to Maxwell’s right hand rule or right hand palm rule no. 1, the direction of B_1 will be perpendicular to the plane of paper and directed downward. Due to this magnetic field, each element of other wire experiences a force. The direction of current element is perpendicular to the magnetic field; therefore the magnetic force on element ab of length L

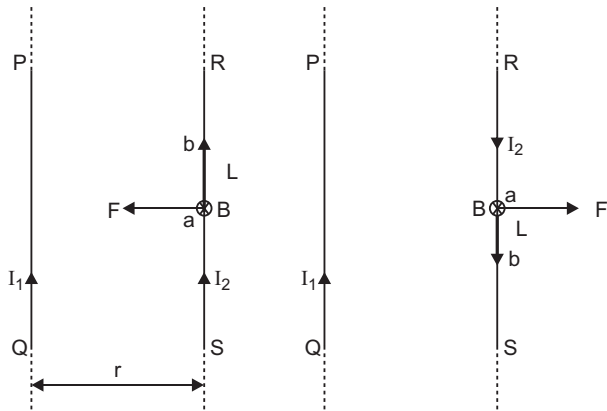

$$F = B_1 I_2 L \sin 90 = \frac{\mu_0 I_1}{2 r} I_2 L$$

The total force on conductor of length L will be

$$F = \frac{\mu_0 I_1 I_2}{2 r} L = \frac{\mu_0 I_1 I_2}{2 r} L$$

Force acting on per unit length of conductor

$$f = \frac{F}{L} = \frac{\mu_0 I_1 I_2}{2 r} \text{ N/m} \dots(ii)$$

- (b) **Definition S.I. unit of Current (Ampere):** In S.I. system of fundamental unit of current ‘ampere’ has been defined assuming the force between the two current carrying wires as standard.

The force between two parallel current carrying conductors of separation r is

$$f = \frac{F}{L} = \frac{\mu_0 I_1 I_2}{2 r} \text{ N/m}$$

If $I_1 = I_2 = 1 \text{ A}, r = 1 \text{ m}$, then

$$f = \frac{\mu_0}{2} = 2 \times 10^{-7} \text{ N/m}$$

Thus 1 ampere is the current which when flowing in each of parallel conductors placed at separation 1 m in vacuum exert a force of 2×10^{-7} on 1 m length of either wire.

(c) Magnetic field due to current carrying wire is perpendicular to plane of paper – downward.

i.e., $B = \frac{\mu_0 I}{2d} \hat{k}$

Force $F = qvB$

$$e(v\hat{j}) \times \frac{\mu_0 I}{2d} \hat{k} = \frac{e\mu_0 I v}{2d} \hat{i}$$

That is the magnetic force has magnitude $\frac{e\mu_0 I v}{2d}$ and is directed along positive x-axis i.e., in

the plane of paper perpendicular to direction of v and to the right.

29. Faraday’s law of electromagnetic induction states that whenever there is a change in magnetic flux linked with of a coil, an emf is induced in the coil. The induced emf is proportional to the rate of change of magnetic flux linked with the coil.

i.e., $e = -\frac{d\phi}{dt}$

If the coil contains N -turns, then $e = -N \frac{d\phi}{dt}$

Let length of conductor $PQ = l$

As $x = 0$, magnetic flux $= 0$.

When PQ moves a small distance from x to $x + dx$, then magnetic flux linked $= B dA = B l dx$

The magnetic field is from $x = 0$ to $x = b$, so final magnetic flux $= \int_0^b B l dx = B l b$ (increasing)

Mean magnetic flux from $x = 0$ to $x = b$ is $\frac{1}{2} B l b$.

The magnetic flux from $x = b$ to $x = 2b$ is zero.

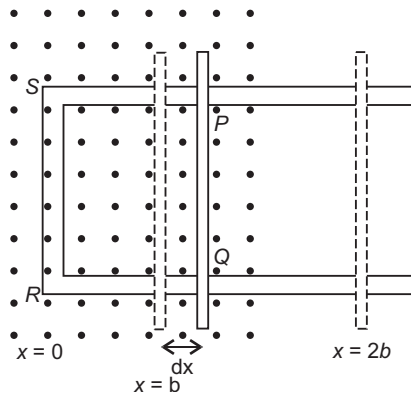

Induced emf, $\frac{d}{dt} \int_0^b B l dx$

$$Bl \frac{dx}{dt} = Blv$$

where $v = \frac{dx}{dt}$ velocity of arm PQ from $x = 0$ to $x = b$.

During return from $x = 2b$ to $x = b$, the induced emf is zero; but now area is decreasing so magnetic flux is decreasing, and induced emf will be in opposite direction.

$$Blv$$

Graph is shown in figure.

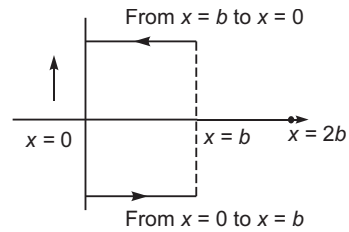
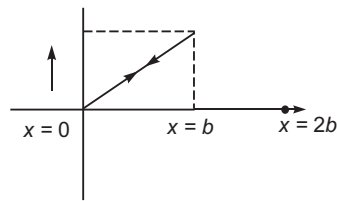

OR

Principle: When alternating current source is connected to the ends of primary coil, the current changes continuously in the primary coil; due to which the magnetic flux linked with the secondary coil changes continuously, therefore the alternating emf of same frequency is developed across the secondary.

Let N_p be the number of turns in primary coil, N_s the number of turns in secondary coil and the magnetic flux linked with each turn. **We assume that there is no leakage of flux so that the flux linked with each turn of primary coil and secondary coil is the same.** According to Faraday's laws the emf induced in the primary coil

$$e_p = N_p \frac{d\phi}{dt} \quad \dots(i)$$

and emf induced in the secondary coil

$$e_s = N_s \frac{d\phi}{dt} \quad \dots(ii)$$

From (i) and (ii)

$$\frac{e_s}{e_p} = \frac{N_s}{N_p} \quad \dots(iii)$$

If the resistance of primary coil is negligible, the emf (e_p) induced in the primary coil, will be equal to the applied potential difference (V_p) across its ends. Similarly if the secondary circuit is open, then the potential difference V_s across its ends will be equal to the emf (e_s) induced in it; therefore

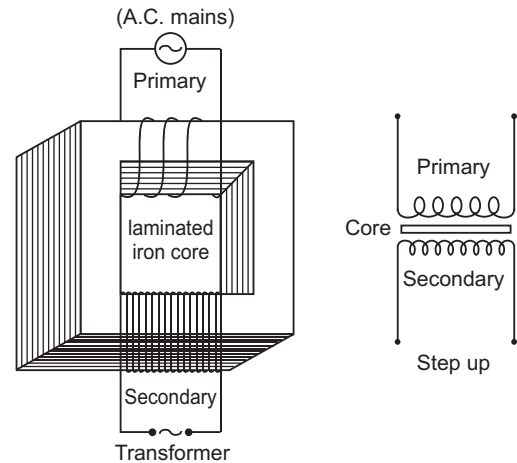

$$\frac{V_S}{V_p} = \frac{I_p}{I_S} = \frac{N_S}{N_p} = r \text{ (say)} \quad \dots(iv)$$

where $r = \frac{N_S}{N_p}$ is called the *transformation ratio*. If i_p and i_s are the instantaneous currents in primary and secondary coils and there is no loss of energy; then

For about 100% efficiency, Power in primary = Power in secondary

$$\frac{V_p i_p}{V_S i_S} = \frac{N_p}{N_S} = \frac{1}{r} \quad \dots(v)$$

In step up transformer, $N_S > N_p$ $r > 1$;

So $V_S > V_p$ and $i_S < i_p$

i.e., step up transformer increases the voltage.

When output voltage increases, the output current automatically decreases to keep the power same. Thus, there is no violation of conservation of energy in a step up transformer.

Step up transformer is used at power house to transmit power at high voltage 11000 V or 33000 V. The current in wires at this voltage is quite small, so power loss $I^2 R$ is negligible. At town, the step down transformer is used to supply power at 220 V. This saves enormous electrical energy.

30. (a) (i) Forward Bias:

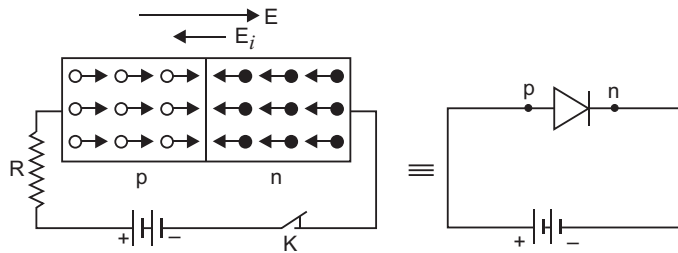

Forward current

(ii) Reverse Bias:

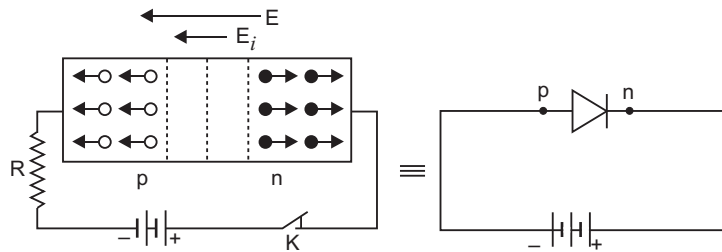

Reverse current

Reverse biasing

The battery is connected to the diode through a potentiometer (or rheostat) so that the applied voltage to the diode can be changed. For different values of voltages, the value of the current is noted. A graph between V and I is obtained as in figure. Note that in forward bias measurement, we use a milliammeter since the expected current is large while a micrometer is used in reverse bias to measure current.

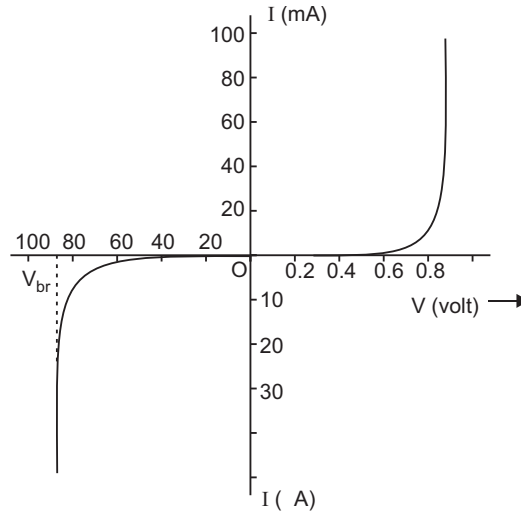

V-I characteristics of a silicon diode

(b) Light Emitting Diode (LED):

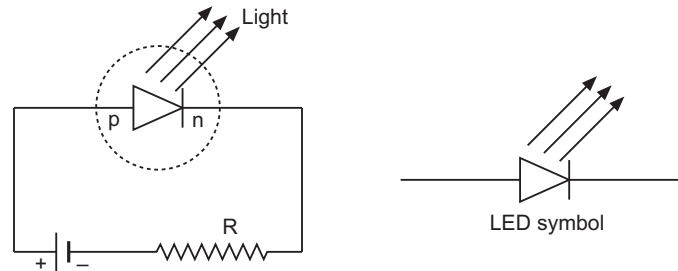

A light emitting diode is simply a forward biased p - n junction which emits spontaneous light radiation. When forward bias is applied, the electron and holes at the junction recombine and energy released is emitted in the form of light. For visible radiation phosphorus doped GaAs is commonly used.

The advantages of LEDs are:

- (i) Low operational voltage and less power.
- (ii) Fast action with no warm up time.
- (iii) Emitted light is nearly monochromatic radiation.
- (iv) They have long life.

OR

(a) **Characteristic Curves:** The circuit diagram for determining the static characteristic curves of an *n-p-n* transistor in common-emitter configuration is shown in figure.

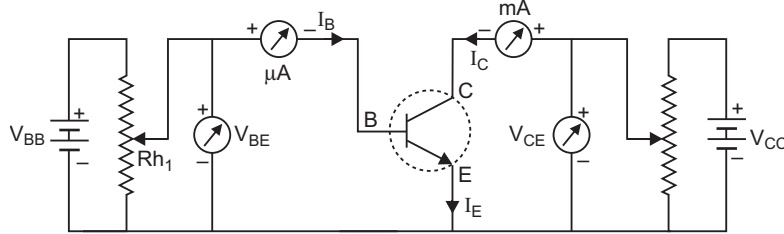

Common Emitter Characteristics:

(i) **Input characteristics:** These characteristic curves are obtained by plotting base current (I_B) versus base-emitter voltage V_{BE} for fixed collector-emitter voltage V_{CE} . Fig. represents these characteristics.

(ii) **Output characteristics:** These characteristics are obtained by plotting collector current I_C versus collector-emitter voltage V_{CE} at a fixed value of base current I_B . The base current is changed to some other fixed value and the observations of I_C versus V_{CE} are repeated. Fig. represents the output characteristics of a common-emitter circuit.

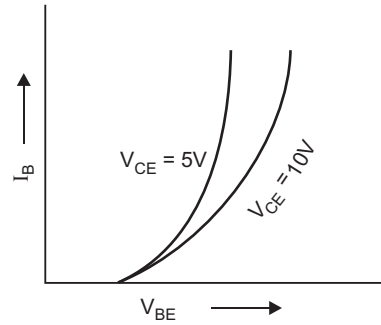

Input Resistance. It is the ratio of change in base-emitter voltage (V_{BE}) to the corresponding change in base current (I_B) at constant collector-emitter voltage V_{CE} , i.e.,

$$r_i = \frac{V_{BE}}{I_B} \quad V_{CE} \text{ constant}$$

The input resistance of a common emitter circuit is of the order of a few hundred ohms.

Current amplification factors of a transistor (α and β):

The current gain α is defined as the ratio of change in collector current to the change in emitter current for constant value of collector voltage in *common base configuration* i.e.,

$$\alpha = \frac{I_C}{I_E} \quad V_C \text{ constant} \quad \dots(i)$$

Practical value of α ranges from 0.9 to 0.99 for junction transistor.

The current gain β is defined as the ratio of change in collector current to the change in base current for constant value of collector voltage in *common emitter configuration* i.e.,

$$\beta = \frac{I_C}{I_B} \quad V_C \text{ constant} \quad \dots(ii)$$

The value of β ranges from 20 to 200.

The current gains α and β are related as

$$\alpha = \frac{\beta}{1 + \beta} \quad \text{or} \quad \beta = \frac{\alpha}{1 - \alpha} \quad \dots(iii)$$

(b) **A transistor as an Oscillator:**

Circuit Operation. When the collector supply voltage is switched on by closing switch S , collector current starts increasing and the capacitor C is charged. When the capacitor attains maximum charge, it discharges through coil L , setting up oscillations of natural frequency.

$$f = \frac{1}{2\sqrt{LC}}$$

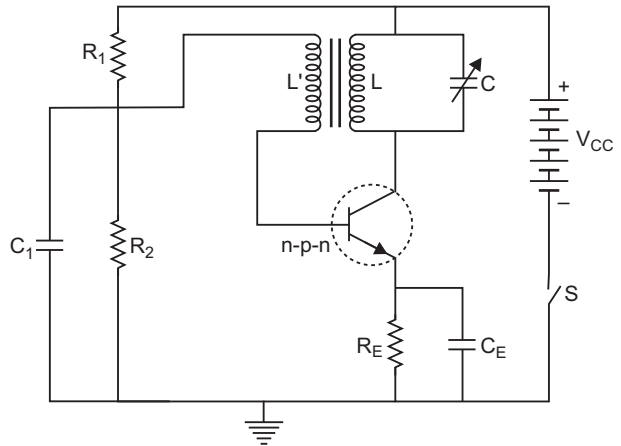

These oscillations induce a small voltage in coil L by mutual induction. This induced voltage is the feed back voltage; its frequency is same as that of resonant LC circuit but its magnitude depends on the number of turns in L and coupling between L and L . The feedback voltage is applied between the base and emitter and appears in the amplified form in the collector circuit. A part of this amplifier energy is used to meet losses taking place in oscillatory circuit to maintain oscillations in tank circuit and the balance is radiated out in the form of electromagnetic waves.

Positive Feed back. The feed back applied in tuned collector oscillator circuit is positive. This may be seen as follows: A phase shift of 180° is created between the voltages of L and L due to *transformer action*. A further phase shift of 180° arises between base-emitter and collector circuit due to *transistor action in CE configuration*. Thus the net phase becomes 360° (or zero); which is the required condition for a positive feed back. Due to positive feed back the energy fed back to the tank circuit is in phase with the generated oscillations, thus maintaining oscillations.

CBSE (All India) SET-II

1. $E_I = Rhc \frac{1}{1^2} = \frac{1}{2^2} = \frac{3}{4} Rhc$

$E_{II} = Rhc \frac{1}{1^2} = \frac{1}{2} Rhc$

Ratio $\frac{E_I}{E_{II}} = \frac{3}{4}$

4. $F_m = qvB = F_m \hat{j} = ev \hat{i} \times \hat{k}$

For validity of this equation, the direction of magnetic field must be along z -axis, since $(\hat{i} \times \hat{k}) = -\hat{j}$

5. X -rays has shortest wavelength.

12. In rectangular coil the induced emf will remain constant because in this the case rate of change of area in the magnetic field region remains constant, while in circular coil the rate of change of area in the magnetic field region is not constant.

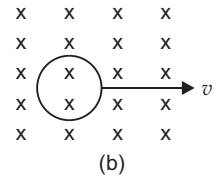
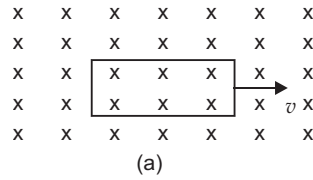

19. (i) Equivalent capacitance of C_1, C_2 and C_3 in series is C

$$\frac{1}{C} = \frac{1}{C_1} + \frac{1}{C_2} + \frac{1}{C_3}$$

$$C = 5 \text{ F}$$

$$C_{eq} = C = 5 \text{ F}$$

- (ii) Charge on C_4

$$q_4 = C_4 V = 500 \times 15 = 7500 \text{ C}$$

- (iii) Charge on C_1, C_2 and C_3 is

$$q_1 = q_2 = q_3$$

$$C V = 5 \text{ F} \times 500 \text{ V} = 2500 \text{ C} = 2.5 \text{ mC}$$

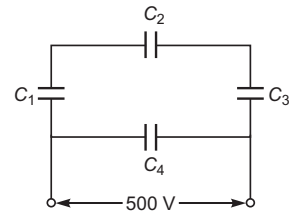

20. $r = \frac{E}{V} = \frac{1}{R} = \frac{2}{15} = 0.133$

22. Given $d = 0.12 \text{ mm} = 0.12 \times 10^{-3} \text{ m}$

$$420 \text{ nm} = 420 \times 10^{-9} \text{ m}, D = 1.0 \text{ m}$$

$$(a) (i) y_2 = \frac{nD}{d} = \frac{2 \times 1.0 \times 420 \times 10^{-9}}{0.12 \times 10^{-3}} = 7 \times 10^{-3} \text{ m} = 7 \text{ mm}$$

$$y_2 = n \frac{h}{2} \frac{1}{d} = 2 \times \frac{1}{2} \times \frac{1.0 \times 420 \times 10^{-9}}{0.12 \times 10^{-3}}$$

$$\frac{3}{2} \times \frac{1.0 \times 4.2 \times 10^{-7}}{1.2 \times 10^{-4}} = 5.25 \times 10^{-3} \text{ m} = 5.25 \text{ mm}$$

23. From Kirchhoff's law

$$I_3 = I_1 = I_2 \quad \dots(i)$$

Applying Kirchhoff's II law to loop ACBPA

$$12I_3 - 0.5I_1 - 6 = 0$$

$$0.5I_1 - 12I_3 - 6 = 0 \quad \dots(ii)$$

Applying Kirchhoff's II law to loop ACBQA

$$12I_3 - 1I_2 - 10 = 0$$

$$I_2 - 12I_3 - 10 = 0 \quad \dots(iii)$$

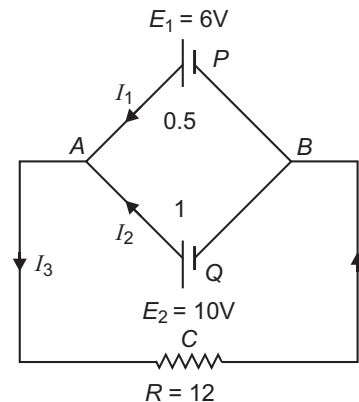

27. Given $\frac{I}{0} = \frac{v}{u} = 4$ $v = 4u$

From lens formula

$$\frac{1}{f} = \frac{1}{v} - \frac{1}{u},$$

$$\frac{1}{20} = \frac{1}{4u} - \frac{1}{u}$$

$$u = 15 \text{ cm}$$

thus, $v = 4 \times (15) = \mathbf{60 \text{ cm}}$

Object distance = 15 cm

Image distance from lens = **60 cm**.

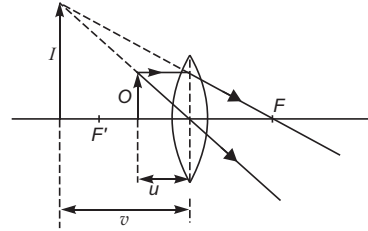

CBSE (AI) Set-III

5. Radiowaves, Infrared light, Blue light, X-rays.

8. Kinetic energy, $K = \frac{1}{2}mv^2 = \frac{1}{4} \frac{e^2}{r}$... (i)

Potential energy, $U = \frac{1}{4} \frac{e^2}{r}$... (ii)

Total energy $E = K + U = \frac{1}{4} \frac{e^2}{r}$... (iii)

Comparing equations (i), (ii), (iii), we have

$$K = E \text{ and } U = 2E$$

Given $E = 13.6 \text{ eV}$ (in ground state)

Kinetic energy, $K = 13.6 \text{ eV}$

Potential energy $U = 2 \times (13.6 \text{ eV}) = \mathbf{27.2 \text{ eV}}$

21. $v = 10 \text{ m}$

Real image is formed on screen, so image is inverted.

$$\frac{v}{u} = 19,$$

$$u = \frac{v}{19} = \frac{10}{19} \text{ m}$$

Lens formula $\frac{1}{f} = \frac{1}{v} - \frac{1}{u}$ gives

$$\frac{1}{f} = \frac{1}{10} - \frac{19}{10} = \frac{20}{10} = 2$$

$$f = \frac{1}{2} \text{ m} = \mathbf{50 \text{ cm}}$$

$$24. \quad r = \frac{E}{4} \quad 1 \quad R = \frac{2.5}{2.0} \quad 1 \quad 5$$

$$\frac{5}{4} \quad \mathbf{1.25}$$

25. (a) (i) For II bright fringe,

$$y_2 = \frac{mD}{d} = \frac{2 \cdot 1.0 \cdot 600 \cdot 10^{-9}}{0.20 \cdot 10^{-3}}$$

$$6 \cdot 10^{-3} \text{ m} \quad \mathbf{6 \text{ mm}}$$

For II dark fringe,

$$y_2 = n \cdot \frac{1}{2} \cdot \frac{D}{d} = 2 \cdot \frac{1}{2} \cdot \frac{1.0 \cdot 600 \cdot 10^{-9}}{0.20 \cdot 10^{-3}}$$

$$4.5 \cdot 10^{-3} \text{ m} \quad \mathbf{4.5 \text{ mm}}$$

26. From Kirchhoff's I law $I_3 = I_1 = I_2$... (i)

Applying Kirchhoff's II law to loop $PRSP$

$$20I_3 - 200I_2 - 5 = 0$$

$$40I_2 - 4I_3 - 1$$

... (ii)

Applying Kirchhoff's II law to loop $PRQP$

$$20I_3 - 60I_1 - 4 = 0 \quad 15I_1 - 5I_3 - 1$$

... (iii)

CBSE EXAMINATION PAPERS

FOREIGN-2010

Time allowed: 3 hours

Maximum marks: 70

General Instructions:

- All questions are compulsory.
- There are 30 questions in total. Questions 1 to 8 carry one mark each, questions 9 to 18 carry two marks each, questions 19 to 27 carry three marks each and questions 28 to 30 carry five marks each.
- There is no overall choice. However, an internal choice has been provided in one question of two marks, one question of three marks and all three questions of five marks each. You have to attempt only one of the given choices in such questions.
- Use of calculators is not permitted.
- You may use the following values of physical constants wherever necessary:

$$c = 3 \times 10^8 \text{ ms}^{-1} \quad h = 6.626 \times 10^{-34} \text{ Js}$$

$$e = 1.602 \times 10^{-19} \text{ C} \quad \mu_0 = 4\pi \times 10^{-7} \text{ TmA}^{-1}$$

$$\frac{1}{4\pi\epsilon_0} = 9 \times 10^9 \text{ Nm}^2\text{C}^{-2}$$

$$\text{Boltzmann's constant } k = 1.381 \times 10^{-23} \text{ JK}^{-1}$$

$$\text{Avogadro's number } N_A = 6.022 \times 10^{23} / \text{mole}$$

$$\text{Mass of neutron } m_n = 1.675 \times 10^{-27} \text{ kg}$$

$$\text{Mass of electron } m_e = 9.1 \times 10^{-31} \text{ kg}$$

$$\text{Radius of earth} = 6400 \text{ km}$$

CBSE (Foreign) SET-I

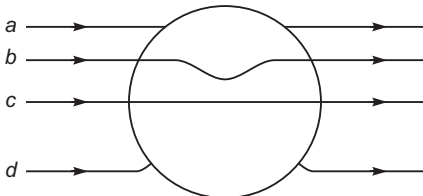
- A charge Q C is placed at the centre of a cube. What is the electric flux coming out from any one surface?
- What is the characteristic property of a diamagnetic material?
- Which part of the electromagnetic spectrum is used in satellite communication?
- A metallic sphere is placed in a uniform electric field as shown in the figure. Which path is followed by electric field lines and why?

- Why does the sky appear blue?
- Name an experiment which shows wave nature of electrons. Which phenomenon was observed in this experiment using an electron beam?

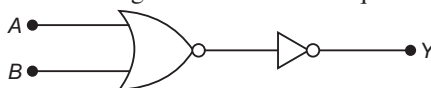
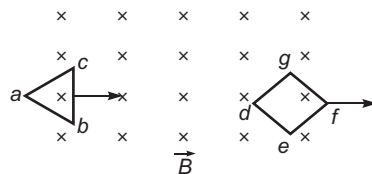
7. Two loops of different shapes are moved in a region of uniform magnetic field in the directions marked by arrows as shown in the figure. What is the direction of the induced current in each loop?
8. State Bohr's quantisation condition for defining stationary orbits.
9. In standard AM broadcast, what mode of propagation is used for transmitting a signal? Why is this mode of propagation limited to frequencies upto a few MHz?
10. Write the truth table for the following circuit. Name the equivalent gate that this circuit represents.



11. Define drift velocity. Write its relationship with relaxation time in terms of the electric field E applied to a conductor.
A potential difference V is applied to a conductor of length L . How is the drift velocity affected when V is doubled and L is halved?

OR

Define ionic mobility. Write its relationship with relaxation time.
How does one understand the temperature dependence of resistivity of a semiconductor?

12. If both the number of protons and the number of neutrons are conserved in a nuclear reaction like

$${}^1_6\text{C} + {}^{12}_6\text{C} \rightarrow {}^{20}_{10}\text{Ne} + {}^4_2\text{He}$$
 in what way is mass converted into energy? Explain.

13. Draw a ray diagram to show the formation of the image in a myopic eye. Show with the help of a ray diagram how this defect is corrected.
14. An β -particle and a proton moving with the same speed enter the same magnetic field region at right angles to the direction of the field. Show the trajectories followed by the two particles in the region of the magnetic field. Find the ratio of the radii of the circular paths which the two particles may describe.

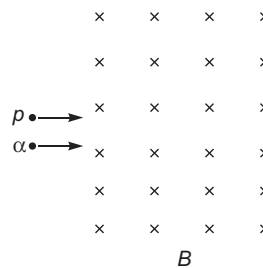

15. State the principle of working of a potentiometer. Define potential gradient and write its S.I. unit.
16. Define the resolving power of a microscope. How is this affected when
 - (i) the wavelength of illuminating radiations is decreased, and
 - (ii) the diameter of the objective lens is decreased?
 Justify your answer.
17. Two long co-axial solenoids of the same length but different radii and different number of turns are wound one over the other. Deduce the expression for the mutual inductance of this arrangement.
18. How are X-rays produced? Write their two important uses.

19. (a) Plot a graph comparing the variation of potential ' V ' and electric field ' E ' due to a point charge ' Q ' as a function of distance ' R ' from the point charge.
- (b) Find the ratio of the potential differences that must be applied across the parallel and the series combination of two identical capacitors so that the energy stored, in the two cases, becomes the same.
20. A parallel beam of monochromatic light of wavelength 500 nm falls normally on a narrow slit and the resulting diffraction pattern is obtained on a screen 1 m away. It is observed that the first minimum is at a distance of 2.5 mm from the centre of the screen. Find
- (a) the width of the slit.
- (b) the distance of the second maximum from the centre of the screen.
- (c) the width of the central maximum.

OR

A beam of light consisting of two wavelengths, 650 nm and 520 nm, is used to obtain interference fringes in a Young's double slit experiment. What is the least distance from the central maximum where the bright fringes due to the both the wavelengths coincide? The distance between the slits is 2 mm and the distance between the plane of the slits and screen is 120 cm.

21. Draw a schematic arrangement of the Geiger – Marsden experiment for studying α -particle scattering by a thin foil of gold. Describe briefly, by drawing trajectories of the scattered α -particles, how this study can be used to estimate the size of the nucleus.
22. (a) How is the focal length of a spherical mirror affected when the wavelength of the light used is increased?
- (b) A convex lens has 20 cm focal length in air. What is its focal length in water? (Refractive index of air-water = 1.33, refractive index of air-glass = 1.5).
23. A network of resistors is connected to a 16 V battery of internal resistance of 1 Ω as shown in the figure.

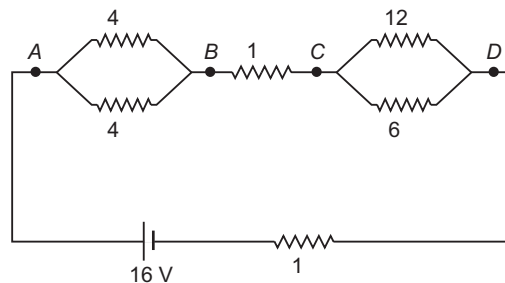

- (a) Compute the equivalent resistance of the network.
- (b) Obtain the voltage drops V_{AB} and V_{CD} .
24. (a) How is the electric field due to a charged parallel plate capacitor affected when a dielectric slab is inserted between the plates fully occupying the intervening region?
- (b) A slab of material of dielectric constant K has the same area as the plates of a parallel plate capacitor but has thickness $\frac{1}{2}d$, where d is the separation between the plates. Find the expression for the capacitance when the slab is inserted between the plates.
25. Draw a schematic diagram of a reflecting telescope (Cassegrain). Write two important advantages that the reflecting telescope has over a refracting type.

26. Define the terms ‘threshold frequency’ and ‘stopping potential’ in the study of photoelectric emission.

Explain briefly the reasons why wave theory of light is not able to explain the observed features in photoelectric effect.

27. (a) State briefly any two reasons explaining the need for modulating a signal.
 (b) Draw a labelled block diagram of a simple modulator for obtaining an AM signal.
28. (a) State Ampere’s circuital law.
 (b) Use it to derive an expression for magnetic field inside, along the axis of an air cored solenoid.
 (c) Sketch the magnetic field lines for a finite solenoid. How are these field lines different from the electric field lines from an electric dipole?

OR

- (a) Using Biot-Savart Law, deduce an expression for the magnetic field on the axis of a circular current loop.
 (b) Draw the magnetic field lines due to a current carrying loop.
 (c) A straight wire carrying a current of 12 A is bent into a semi-circular arc of radius 20 cm as shown. What is the magnetic field B at O due to (i) straight segments (ii) the semi-circular arc?

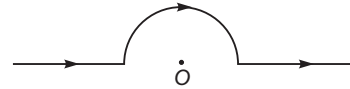

29. (a) A resistor of 400Ω , an inductor of $\frac{5}{2} \text{ H}$ and a capacitor of $\frac{50}{3} \text{ F}$ are connected in series across a source of alternating voltage of $140 \sin 100 \pi t$ volts.
 Find the voltage (rms) across the resistor, the inductor and the capacitor. Is the algebraic sum of these voltages more than the source voltage? If yes, resolve the paradox. (Given $\sqrt{2} = 1.4$)
 (b) An ideal capacitor having a charge $q = q_0 \cos \omega t$ is connected across an ideal inductor ‘ L ’ through a switch ‘ S ’. On closing the switch, show that the sum of the energies in the capacitor and inductor is constant in time in the free oscillations of the LC circuits.

OR

- (a) What are eddy currents? How are these currents reduced in the metallic cores of transformers?
 (b) A step down transformer operates on a 2.5 KV line. It supplies a load with 20 A. The ratio of the primary winding to the secondary is 10: 1. If the transformer is 90% efficient, calculate:
 (i) the power output,
 (ii) the voltage, and
 (iii) the current in the secondary.
30. (a) Draw I - V characteristics of a Zener diode.
 (b) Explain with the help of a circuit diagram, the use of a Zener diode as a voltage-regulator.
 (c) A photodiode is operated under reverse bias although in the forward bias the current is known to be more than the current in the reverse bias. Explain giving reason.

OR

- (a) Draw the circuit diagram of a base-biased n - p - n transistor in C - E configuration. Explain how this circuit is used to obtain the transfer characteristic (V_o vs V_i characteristics). How do we explain the working of a transistor as a switch using the characteristic?

- (b) The typical output characteristics (I_C vs V_{CE}) of an $n-p-n$ transistor in $C-E$ configuration is shown in the figure. Calculate (i) the output resistance r_0 and (ii) the current amplification factor β_{ac} .

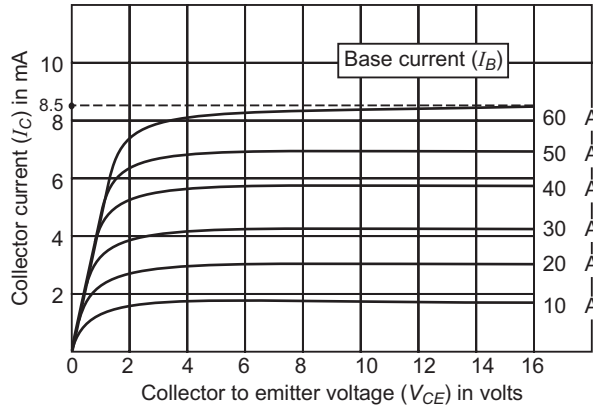

CBSE (Foreign) SET-II

Questions uncommon to Set-I

4. A circular loop is moved through the region of uniform magnetic field. Find the direction of induced current (clockwise or anticlockwise) when the loop moves:
- into the field, and
 - out of the field.

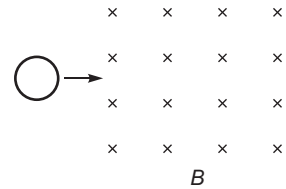

8. Name the electromagnetic radiation used to destroy cancer cells and write its frequency range.
10. How are infra-red rays produced? Write their two important uses.
11. State the principle on which the working of a meter bridge is based. Under what condition is the error in determining the unknown resistance minimized?
12. An electron and a proton moving with the same speed enter the same magnetic field region at right angles to the direction of the field. Show the trajectory followed by the two particles in the magnetic field. Find the ratio of the radii of the circular paths which the particles may describe.
13. Write the truth table for the following circuit. Name the gate that this circuit represents.

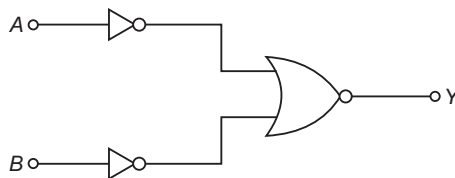
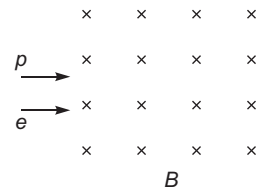

18. Draw a ray diagram to show the formation of the image in a myopic eye. Show with the help of a ray diagram how this defect is corrected.
21. Two cells E_1 and E_2 of EMF's 5 V and 9 V and internal resistances of 0.3 Ω and 1.2 Ω respectively are connected to a network of resistances as shown in the figure. Calculate the value of current flowing through the 3 Ω resistance.

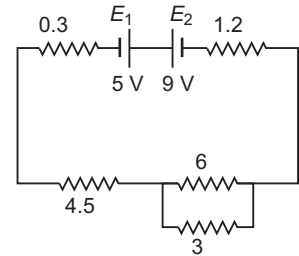

22. (a) Plot a graph comparing the variation of potential ' V ' and electric field ' E ' due to a point charge ' Q ' as a function of distance ' R ' from the point charge.
 (b) Find the ratio of the potential differences that must be applied across the parallel and the series combination of two capacitors C_1 and C_2 with their capacitances in the ratio 1: 2 so that the energy stored, in the two cases, becomes the same.
23. (a) How is the focal length of a spherical mirror affected when it is immersed in water.
 (b) A convex lens has 10 cm focal length in air. What is its focal length in water? (Refractive index of air-water = 1.33, refractive index of air-glass = 1.5).

CBSE (Foreign) SET-III

Questions uncommon to Set-I and Set-II

5. To which part of the electromagnetic spectrum do the waves emitted by radioactive nuclei belong? What is its frequency range?
6. A rectangular loop of wire is pulled to the right, away from the long straight wire through which a steady current I flows upwards. What is the direction of induced current in the loop?

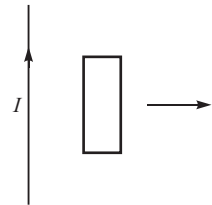

9. Draw the output waveform for the following gate. Also, name the gate.

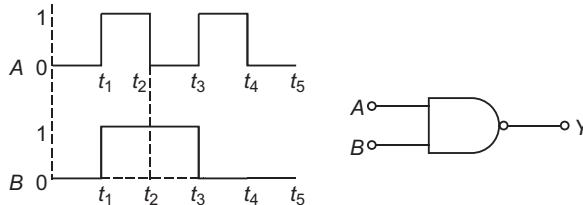

13. How are microwaves produced? Write their two important uses.
15. Draw a ray diagram to show the formation of the image in a far-sighted (hypermetropic) eye. Show with the help of a ray diagram how this defect is corrected.
19. (a) Plot a graph comparing the variation of potential ' V ' and electric field ' E ' due to a point charge ' Q ' as a function of distance ' R ' from the point charge.

(b) Find the ratio of the potential differences that must be applied across the parallel and the series combination of two capacitors C_1 and C_2 with their capacitances in the ratio 1: 3 so that the energy stored, in the two cases, becomes the same.

20. Calculate the steady current through the 2 Ω resistor in the circuit shown below.

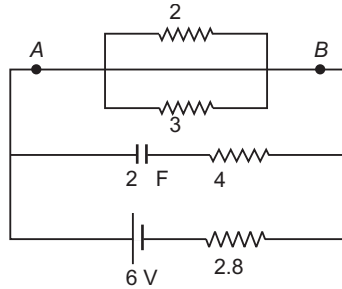

Solutions

CBSE (Foreign) SET-I

1. $\frac{Q}{6 \epsilon_0}$ V - m

2. **Diamagnetic substances:** These are the substances in which feeble magnetism is produced in a direction opposite to the applied magnetic field. These substances are repelled by a strong magnet.

These substances have small negative values of magnetism M and susceptibility and positive low value of relative permeability μ_r , i.e.,

$$\mu_r < 1, \chi < 0, M < 0$$

The examples of diamagnetic substances are bismuth, antimony, copper, lead, water, nitrogen (at STP) and sodium chloride.

3. **Short radiowaves** 10 m or ν 30 MHz are used in satellite communication.

4. Path (d) is followed by electric field line.

Reason: There are no electric field lines within a metallic sphere and field lines are normal at each point of the surface.

5. The light is scattered by air molecules. According to Lord Rayleigh the intensity of scattered light

$$I \propto \frac{1}{(\text{wavelength})^4} \quad I \propto \frac{1}{\lambda^4}$$

As *blue* λ *red*, accordingly blue colour is scattered the most and red the least, so sky appears **blue**.

6. Davission-Germer experiment shows wave nature of electrons.

The phenomenon of **diffraction of electron beam was observed in this experiment** to produce magnetic field upward.

7. The induced current always opposes the change in magnetic flux. Loop *abc* is entering the magnetic field; so magnetic flux linked with loop tends to increase, so current induced in loop *abc* is **anticlockwise** to produce magnetic field upward to oppose the increase in flux. Loop *defg* is

leaving the magnetic field; so flux linked with it tends to decrease, the induced current will be clockwise to produce magnetic field downward to oppose the decrease in magnetic flux.

8. Quantum Condition: The stationary orbits are those in which angular momentum of electron is an integral multiple of $\frac{h}{2\pi}$ i.e.,

$$mvr = n \frac{h}{2\pi}, \quad n = 1, 2, 3, \dots \quad \dots(ii)$$

Integer n is called the **principal quantum number**. This equation is called Bohr's quantum condition.

9. Sky wave propagation.

Above a frequency of few MHz, the electromagnetic wave penetrate and escape.

10. $Y = \overline{A} B + A \overline{B}$

The equivalent gate is OR gate.

The Truth Table.

Input		Output
A	B	Y
0	0	0
1	0	1
0	1	1
1	1	1

11. **Drift velocity** is defined as the average velocity with which the free electrons get drifted towards the positive end of the conductor under the influence of an external electric field applied. It is given by

$$v_d = \frac{e E}{m}$$

where m = mass of electron, e = charge of electron

E = electric field applied

Becomes 4 times.

OR

Mobility of an ion is defined as the drift velocity per unit electric field i.e.,

$$\frac{v_d}{E} = \frac{e}{m}$$

Its unit is m^2/Vs .

When temperature increases, covalent bonds of neighbouring atoms break and charge carrier become free to cause conductive, so resistivity of semi-conductor decreases with rise of temperature.

12. In fact the number of protons and number of neutrons are same before and after a nuclear reaction, but the binding energies of nuclei present before and after a nuclear reaction are different. This difference is called the mass defect. This mass defect appears as energy of reaction. In this sense a nuclear reaction is an example of mass-energy interconversion.

- 13. Myopia or shortsightedness:** Myopia is the defect of eye in which a person can see only nearby objects, but fails to see the far away objects distinctly. This defect is due to

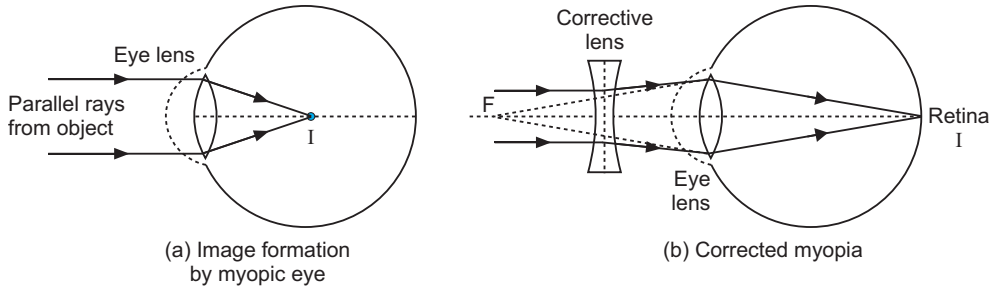

- (a) decrease in focal length of the eye lens.
 (b) Spreading of the eye-sphere.

Due to these reasons the image is formed in front of the retina.

- 14. Radius of charged particle in magnetic field**

$$r = \frac{mv}{qB}$$

$$\frac{m}{q} \text{ for same } v \text{ and } B.$$

$$\frac{r_p}{r} = \frac{(m/q)_p}{((4m_p)/2e)} = \frac{1}{2}$$

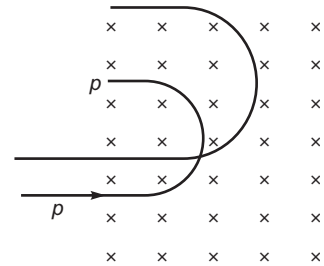

- 15.** It is a device to measure the potential difference across a circuit element accurately. The circuit containing battery B_1 is the main circuit and the circuit containing battery B_2 is the secondary circuit. For the working of potentiometer emf of battery B_1 = emf of battery B_2 .

When a steady current is passed through a potentiometer wire AB , there is a fall of potential along the wire from A to B . The fall of potential per unit length along potentiometer wire is called the potential gradient. If L is length of wire AB and V is the potential difference across it then

$$\text{Potential gradient } k = \frac{V}{L}$$

The S.I. unit of potential gradient is volt/metre.

- 16. Unit of resolution of microscope**

$$d = \frac{1.22}{2n \sin \theta}$$

Resolving power $= \frac{1}{\text{unit of resolution } n \sin \theta}$

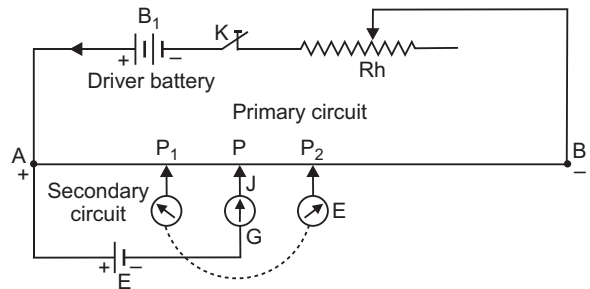

- (i) When wavelength decreases, resolving power increases.
- (ii) When diameter of objective lens decreases, resolving power decreases; so resolving power decreases.

17. Mutual Inductance of Two Co-axial Solenoids :

Consider two long co-axial solenoid each of length l with number of turns N_1 and N_2 wound one over the other. Number of turns per unit length in order (primary) solenoid, $n = \frac{N_1}{l}$ If I_1 is

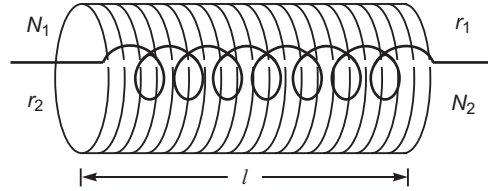

the current flowing in primary solenoid, the magnetic field produced within this solenoid.

$$B_1 = \frac{\mu_0 N_1 I_1}{l} \quad \dots(ii)$$

The flux linked with each turn of inner solenoid coil is $\phi_2 = B_1 A_2$, where A_2 is the cross-sectional area of inner solenoid. The total flux linkage with inner coil of N_2 -turns.

$$\phi_2 = N_2 \phi_1 = N_2 B_1 A_2 = N_2 \frac{\mu_0 N_1 I_1}{l} A_2 = \frac{\mu_0 N_1 N_2 A_2}{l} I_1$$

By definition **Mutual Inductance**, $M_{21} = \frac{\phi_2}{I_1} = \frac{\mu_0 N_1 N_2 A_2}{l}$

If n_1 is number of turns per unit length of outer solenoid and r_2 is radius of inner solenoid, then $M = \mu_0 n_1 N_2 \pi r_2^2$.

18. Production of X-rays: When high energetic electrons strike a metallic target of high atomic weight and high melting point, X-rays are produced. In production of X-rays mechanical energy of electrons is converted with electromagnetic energy of X-rays.

Uses: X-rays are used in medical diagnostics to detect fractures in bones, tuberculosis of lungs, presence of stone in gallbladder and kidney. They are used in engineering to check flaws in bridges. In physics X-rays are used to study crystal structure.

- 19.** (a) The graph of variation of potential and electric field due to a point charge Q with distance R from the point charge is shown in fig.
 (b) Let C be capacitance of each capacitor.

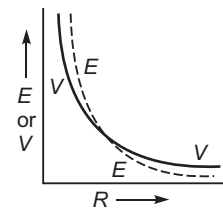

In series arrangement net capacitance $C_s = \frac{C}{2}$.

In parallel arrangement, net capacitance, $C_p = 2C$

Energy stored $U = \frac{1}{2} CV^2$

If V_s and V_p are potential differences applied across series and parallel arrangements, then given

$$\frac{U_s}{U_p} = \frac{\frac{1}{2} C_s V_s^2}{\frac{1}{2} C_p V_p^2} = \frac{V_p}{V_s} \sqrt{\frac{C_s}{C_p}} = \frac{\sqrt{C/2}}{\sqrt{2C}} = \frac{1}{2}$$

20. (a) Given $500 \text{ nm} = 5 \times 10^{-7} \text{ m}$, $D = 1 \text{ m}$

If a is width of slit, then for first minimum

$$\sin \theta = \frac{\lambda}{a}$$

For small θ , $\sin \theta \approx \theta = \frac{y_1}{D}$

$$\frac{y_1}{D} = \frac{\lambda}{a}$$

$$y_1 = \frac{D \lambda}{a} = \frac{1 \times 5 \times 10^{-7}}{2.5 \times 10^{-3}} \text{ m}$$

$$a = \frac{D \lambda}{y_1} = \frac{1 \times 5 \times 10^{-7}}{2.5 \times 10^{-3}} \text{ m} = \mathbf{0.2 \text{ mm}}$$

- (b) Position of n th maximum, $y_n = n \frac{1}{2} \frac{D \lambda}{a}$

For second maximum, $n = 2$

$$(y_2)_{\text{max}} = 2 \times \frac{1}{2} \times \frac{1 \times 5 \times 10^{-7}}{2.5 \times 10^{-3}} = 5 \times 10^{-4} \text{ m} = \mathbf{0.5 \text{ mm}}$$

- (c) Width of central maximum, $\frac{2D \lambda}{a}$

= Separation between first minima on either side of centre of screen

$$2 \times 2.5 \times 10^{-4} \text{ m} = \mathbf{5 \text{ mm}}$$

OR

For least distance of coincidence of fringes, there must be a difference of 1 in order of θ_1 and θ_2 .

As $\theta_1 = \theta_2$, $n_1 \lambda_1 = n_2 \lambda_2$

If $n_1 = n$, $n_2 = n + 1$

$$(y_n)_1 = (y_{n+1})_2 \quad \frac{nD \lambda_1}{d} = \frac{(n+1)D \lambda_2}{d}$$

$$n \lambda_1 = (n+1) \lambda_2 \quad n \frac{520 \text{ nm}}{650 \text{ nm}} = (n+1) \lambda_2 \quad \text{or } n = \frac{520}{130} = 4$$

$$\text{Least distance, } y_{\text{min}} = \frac{nD \lambda_1}{d} = \frac{4 \times 1 \times 650 \times 10^{-9}}{2 \times 10^{-3}}$$

$$2.6 \times 10^{-3} \text{ m} = \mathbf{2.6 \text{ mm}}$$

Here $D = 120 \text{ cm} = 1.2 \text{ m}$

and $d = 2 \text{ mm} = 2 \times 10^{-3} \text{ m}$

$$y_{\text{min}} = \frac{nD \lambda_1}{d} = \frac{4 \times 1.2 \times 650 \times 10^{-9}}{2 \times 10^{-3}} \text{ m}$$

$$1.56 \times 10^{-3} \text{ m} = \mathbf{1.56 \text{ mm}}$$

21. At the suggestion of Rutherford, in 1911, H. Geiger, and E. Marsden performed an important experiment called Geiger-Marsden experiment (or Rutherford's scattering experiment). It consists of

- 1. Source of α -particles :** The radioactive source polonium emits high energetic alpha (α) particles. Therefore, polonium is used as a source of α -particles. This source is placed in an enclosure containing a hole and a few slits A_1, A_2, \dots etc. are placed in front of the hole. This arrangement provides a fine beam of α -particles.
- 2. Thin gold foil :** It is a gold foil* of thickness nearly 10^{-6} m, α -particles are scattered by this foil. The foil taken is thin to avoid multiple scattering of α -particles, *i.e.*, to ensure that α -particle be deflected by a single collision with a gold atom.
- 3. Scintillation counter :** By this the number of α -particles scattered in a given direction may be counted. The entire apparatus is placed in a vacuum chamber to prevent any energy loss of α -particles due to their collisions with air molecules.

Method: When α -particle beam falls on gold foil, the α -particles are scattered due to collision with gold atoms. This scattering takes place in all possible directions. The number of α -particles scattered in any direction is counted by scintillation counter.

Observations and Conclusions

- Most of α -particles pass through the gold foil undeflected. This implies that “*most part of the atom is hollow.*”
- α -particles are scattered through all angles. Some α -particles (nearly 1 in 2000), suffer scattering through angles more than 90° , while a still smaller number (nearly 1 in 8000) retrace their path. This implies that when fast moving positively charged α -particles come near gold-atom, then a few of them experience such a strong repulsive force that they turn back. On this basis Rutherford concluded that whole of positive charge of atom is concentrated in a small central core, called the *nucleus*.

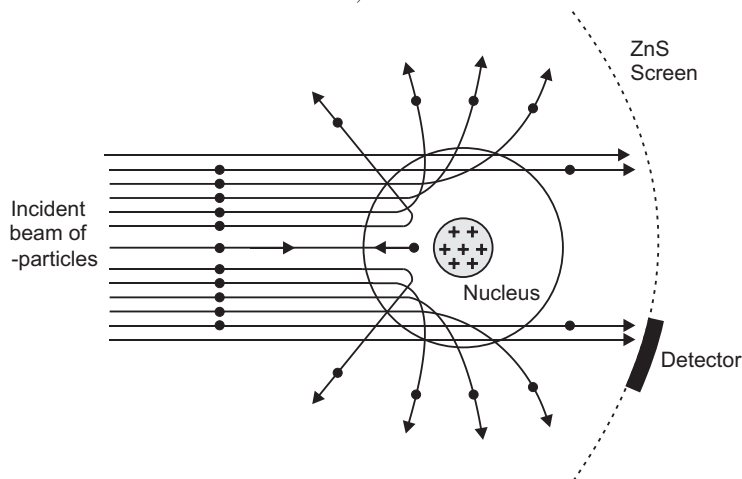

The distance of closest approach of α -particle gives the estimate of nuclear size. If Ze is charge of nucleus E_k kinetic energy of α particle $2e$ charge on α -particle the size of nucleus r_0 is given by

$$E_k = \frac{1}{4} \frac{(Ze)(2e)}{r_0}$$

$$r_0 = \frac{1}{4} \frac{2Ze^2}{E_k}$$

Calculations show that the size of nucleus is of the order of 10^{-14} m, while size of atom is of the order of 10^{-10} m; therefore the size of nucleus is about $\frac{10^{-14}}{10^{-10}} = \frac{1}{10,000}$ times the size of atom.

- (iii) The negative charges (electrons) do not influence the scattering process. This implies that nearly whole mass of atom is concentrated in nucleus.

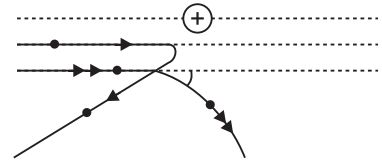

22. (a) Wavelength of light has no effect on focal length of a spherical mirror.
 (b) Given, $f_a = 20$ cm, $n_g = 1.5$, $n_l = \frac{4}{3}$

$$f_l = \frac{n_g}{n_l} \frac{1}{f_a} = \frac{1.5}{\frac{4}{3}} \frac{1}{20} = \frac{1.5 \cdot 3}{4 \cdot 20} = \frac{4.5}{80} = 0.05625 \text{ m} = 5.625 \text{ cm}$$

23. (a) $R_{AB} = \frac{4}{4} \parallel \frac{4}{4} = 2 \Omega$,

$$R_{BC} = 1 \Omega, R_{CD} = \frac{12}{12} \parallel \frac{6}{6} = 4 \Omega$$

Equivalent resistance of network

$$R_{AD} = R_{AB} \parallel R_{BC} \parallel R_{CD} = \frac{2 \cdot 1 \cdot 4}{2 + 1 + 4} = \frac{8}{7} \Omega$$

- (b) Current in circuit $I = \frac{E}{R + r} = \frac{16}{\frac{8}{7} + 1} = 2$ A

$$V_{AB} = R_{AB} I = 2 \cdot 2 = 4 \text{ V}$$

$$V_{CD} = R_{CD} \cdot I = 4 \cdot 2 = 8 \text{ V}$$

24. (a) Initial electric field between the plates, $E_0 = \frac{q/A}{\epsilon_0} = \frac{q}{A \epsilon_0}$

After introduction of dielectric; the permittivity of medium becomes $K \epsilon_0$;

$$\text{so final electric field between the plates, } E = \frac{q}{AK \epsilon_0} = \frac{E_0}{K}$$

i.e., electric field reduces to $\frac{1}{K}$ times.

- (b) Consider a parallel plate capacitor, area of each plate being A , the separation between the plates being d . Let a dielectric slab of dielectric constant K and thickness $t < d$ be placed between the plates. The thickness of air between the plates is $(d - t)$. If charges on plates are $+Q$ and $-Q$, then surface charge density

$$\frac{Q}{A}$$

The electric field between the plates in air, $E_1 = \frac{Q}{\epsilon_0 A}$

The electric field between the plates in slab, $E_2 = \frac{Q}{K \epsilon_0 A}$

The potential difference between the plates

V_{AB} = work done in carrying unit positive charge from one plate to another
 $E \cdot x$ (as field between the plates is not constant).

$$E_1(d - t) + E_2 t = \frac{Q}{\epsilon_0 A}(d - t) + \frac{Q}{K \epsilon_0 A} t$$

$$V_{AB} = \frac{Q}{\epsilon_0 A} \left(d - t + \frac{t}{K} \right)$$

$$\text{Capacitance of capacitor, } C = \frac{Q}{V_{AB}} = \frac{Q}{\frac{Q}{\epsilon_0 A} \left(d - t + \frac{t}{K} \right)}$$

$$\text{or, } C = \frac{\epsilon_0 A}{d - t + \frac{t}{K}} = \frac{\epsilon_0 A}{d - t \left(1 - \frac{1}{K} \right)}$$

Here, $t = \frac{d}{2}$

$$C = \frac{\epsilon_0 A}{d \left(\frac{d}{2} \left(1 - \frac{1}{K} \right) + \frac{d}{2} \right)}$$

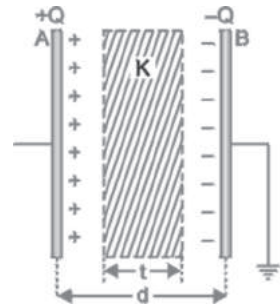

25.

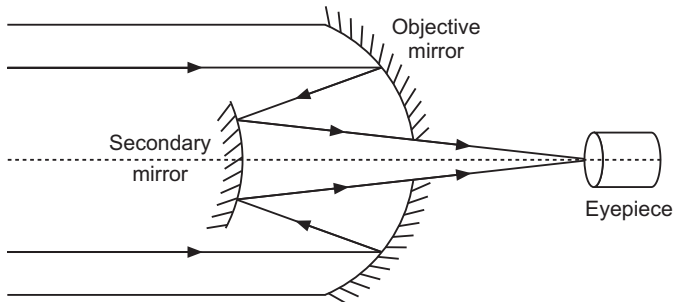

Advantages : (i) It is free from chromatic aberration.

(ii) Its resolving power is greater than refracting telescope due to larger aperture of mirror.

26. Threshold Frequency : The minimum frequency of incident light which is just capable of ejecting electrons from a metal is called the threshold frequency. It is denoted by ν_0 .

Stopping Potential : The minimum retarding potential applied to anode of a photoelectric tube which is just capable of stopping photoelectric current is called the stopping potential. It is denoted by V_0 (or V_S).

The observed characteristics of photoelectric effect could not be explained on the basis of wave theory of light due to the following reasons.

- (i) According to wave theory, the light propagates in the form of wavefronts and the energy is distributed uniformly over the wavefronts. With increase of intensity of light, the amplitude of waves and the energy stored by waves will increase. These waves will then, provide more energy to electrons of metal; consequently the energy of electrons will increase.

Thus, according to wave theory, the kinetic energy of photoelectrons must depend on the intensity of incident light; but according to experimental observations, the kinetic energy of photoelectrons does not depend on the intensity of incident light.

- (ii) According to wave theory, the light of any frequency can emit electrons from metallic surface provided the intensity of light be sufficient to provide necessary energy for emission of electrons, but according to experimental observations, the light of frequency less than threshold frequency can not emit electrons; whatever the intensity of incident light may be.
- (iii) According to wave theory, the energy transferred by light waves will not go to a particular electron, but it will be distributed uniformly to all electrons present in the illuminated surface. Therefore, electrons will take some time to collect the necessary energy for their emission. The time for emission will be more for light of less intensity and vice versa. But experimental observations show that the emission of electrons take place instantaneously after the light is incident on the metal; whatever the intensity of light may be.

27. (a) The modulation is needed due to

- (i) Transmission of audiofrequency electrical signals need long impracticable antenna.
- (ii) The power radiated at audio frequency is quite small, hence transmission is quite lossy.
- (iii) The various information signals transmitted at low frequency get mixed and hence can not be distinguished.

(b) Amplitude Modulation:

The block diagram is shown in fig.

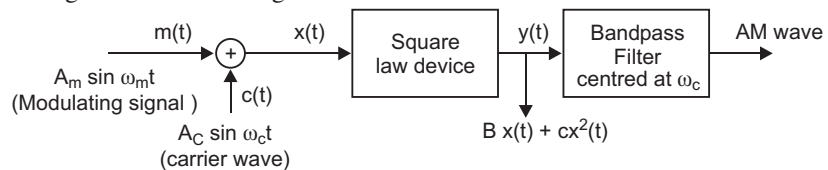

The modulating signal is superposed on carrier wave of high frequency (MHz). The resultant wave so obtained is sent to square law device which produces wave

$$y(t) = Bx(t) + Cx^2(t)$$

This is finally sent to Bandpass filter which rejects dc and sinusoids of frequencies $\omega_m, 2\omega_m, 2\omega_c$ and allows wave of frequency $\omega_c, \omega_c + \omega_m$ and $\omega_c - \omega_m$. The output of Bandpass filter is AM wave.

28. (a) It states that the line integral of magnetic field induction along a closed path is equal to μ_0 -times the current enclosed by the path *i.e.*,

$$\oint \vec{B} \cdot d\vec{l} = \mu_0 I$$

(b) **Magnetic Field Due to a Current Carrying Long Solenoid:**

A solenoid is a long wire wound in the form of a close-packed helix, carrying current. To construct a solenoid a large number of closely packed turns of insulated copper wire are wound on a cylindrical tube of card-board or china clay. When an electric current is passed through the solenoid, a magnetic field is produced within the solenoid. If the solenoid is long and the successive insulated copper turns have no gaps, then the magnetic field within the solenoid is uniform; with practically no magnetic field outside it. The reason is that the solenoid may be supposed to be formed of a large number of circular current elements. The magnetic field due to a circular loop is along its axis and the current in upper and lower straight parts of solenoid is equal and opposite. Due to this the magnetic field in a direction perpendicular to the axis of solenoid is zero and so the resultant magnetic field is along the axis of the solenoid.

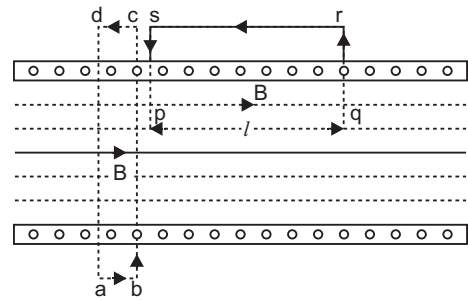
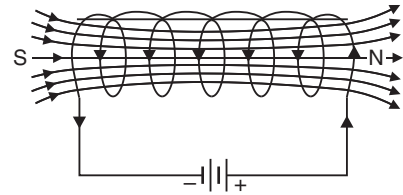

If there are ' n ' number of turns per metre length of solenoid and I amperes is the current flowing, then magnetic field at axis of long solenoid

$$B = \mu_0 n I$$

If there are N turns in length l of wire, then

$$n = \frac{N}{l}$$

or
$$B = \frac{\mu_0 N I}{l}$$

Derivation: Consider a symmetrical long solenoid having number of turns per unit length equal to n .

Let I be the current flowing in the solenoid, then by right hand rule, the magnetic field is parallel to the axis of the solenoid.

Field outside the solenoid: Consider a closed path $abcd$. Applying Ampere's law to this path

$$\oint \vec{B} \cdot d\vec{l} = 0 \text{ (since net current enclosed by path is zero)}$$

As
$$dl = 0 \quad B = 0$$

This means that the magnetic field outside the solenoid is zero.

Field Inside the solenoid: Consider a closed path $pqrs$. The line integral of magnetic field B along path $pqrs$ is

$$\oint_{pqrs} \mathbf{B} \cdot d\mathbf{l} = \int_{pq} \mathbf{B} \cdot d\mathbf{l} + \int_{qr} \mathbf{B} \cdot d\mathbf{l} + \int_{rs} \mathbf{B} \cdot d\mathbf{l} + \int_{sp} \mathbf{B} \cdot d\mathbf{l} \dots(i)$$

For path pq , \mathbf{B} and $d\mathbf{l}$ are along the same direction,

$$\int_{pq} \mathbf{B} \cdot d\mathbf{l} = \int_{pq} B dl = Bl \quad (\text{pq l say})$$

For paths qr and sp , \mathbf{B} and $d\mathbf{l}$ are mutually perpendicular.

$$\int_{qr} \mathbf{B} \cdot d\mathbf{l} = \int_{sp} \mathbf{B} \cdot d\mathbf{l} = \int B dl \cos 90^\circ = 0$$

For path rs , $\mathbf{B} = 0$ (since field is zero outside a solenoid)

$$\int_{rs} \mathbf{B} \cdot d\mathbf{l} = 0$$

In view of these, equation (i) gives

$$\oint_{pqrs} \mathbf{B} \cdot d\mathbf{l} = \int_{pq} \mathbf{B} \cdot d\mathbf{l} = Bl \quad \dots(ii)$$

By Ampere's law $\oint \mathbf{B} \cdot d\mathbf{l} = \mu_0$ net current enclosed by path

$$Bl = \mu_0 (nl I) \quad B = \mu_0 nl$$

This is the well known result.

(c)

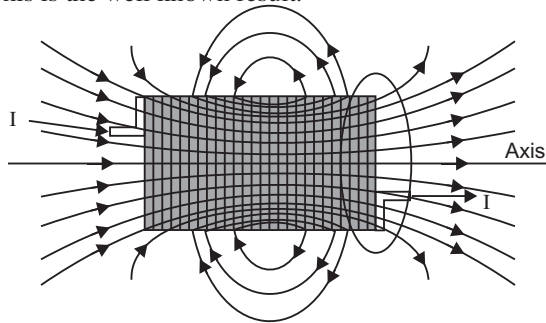

The magnetic field lines of magnet (or current carrying solenoid) form continuous closed loops and are directed from N to S pole outside the magnet and S to N pole inside the magnet and forms closed loops while in the case of an electric dipole the field lines begin from positive charge and end on negative charge or escape to infinity.

OR

(a) **Magnetic field at the axis of a circular loop:**

Consider a circular loop of radius R carrying current I , with its plane perpendicular to the plane of paper. Let P be a point of observation on the axis of this circular loop at a distance x from its centre O . Consider a small element of length l of the coil at point A . The

magnitude of the magnetic induction \mathbf{B} at point P due to this element is given by

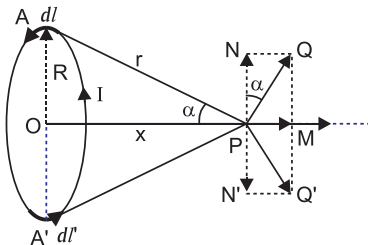

$$B = \frac{\mu_0 I l \sin \theta}{4\pi r^2} \quad \dots(i)$$

The direction of B is perpendicular to the plane containing l and r and is given by right hand screw rule. As the angle between l and r is 90° , the magnitude of the magnetic induction B is given by,

$$B = \frac{\mu_0 I l \sin 90^\circ}{4\pi r^2} = \frac{\mu_0 I l}{4\pi r^2} \quad \dots(ii)$$

In figure B has been represented by PQ . The vector B or (PQ) can be resolved into two components, namely PM and PN along and perpendicular to the axis respectively. Now consider another small current element dl of length l at A . The magnetic induction B due to this element has been represented by PQ whose magnitude is $\frac{\mu_0 I dl}{4\pi r^2}$ and which can also

be resolved into two components; PM and PN along the axis and perpendicular to the axis respectively. Thus if we consider the magnetic induction produced by the whole of the circular coil, then by symmetry the components of magnetic induction perpendicular to the axis will be cancelled out, while those parallel to the axis will be added up. Thus the resultant magnetic induction B at axial point P is along the axis and may be evaluated as follows:

The component of B along the axis,

$$B_x = \frac{\mu_0 I dl}{4\pi r^2} \sin \theta \quad \dots(iii)$$

But $\sin \theta = \frac{R}{r}$ and $r = (R^2 + x^2)^{1/2}$

$$B_x = \frac{\mu_0 I dl}{4\pi r^2} \frac{R}{r} = \frac{\mu_0 IR}{4\pi r^3} dl = \frac{\mu_0 IR}{4\pi (R^2 + x^2)^{3/2}} dl \quad \dots(iv)$$

Therefore the magnitude of resultant magnetic induction at axial point P due to the whole circular coil is given by

$$B = \oint \frac{\mu_0 IR}{4\pi (R^2 + x^2)^{3/2}} dl = \frac{\mu_0 IR}{4\pi (R^2 + x^2)^{3/2}} \oint dl$$

But $\oint dl$ length of the loop $= 2\pi R$... (v)

Therefore, $B = \frac{\mu_0 IR}{4\pi (R^2 + x^2)^{3/2}} (2\pi R)$

$$= \frac{\mu_0 IR^2}{2(R^2 + x^2)^{3/2}} \text{ tesla.}$$

If the coil contains N turns, then

$$B = \frac{\mu_0 N I R^2}{2(R^2 + x^2)^{3/2}} \text{ tesla.}$$

...(vi)

(b) **Magnetic field lines due to a circular current loop:**

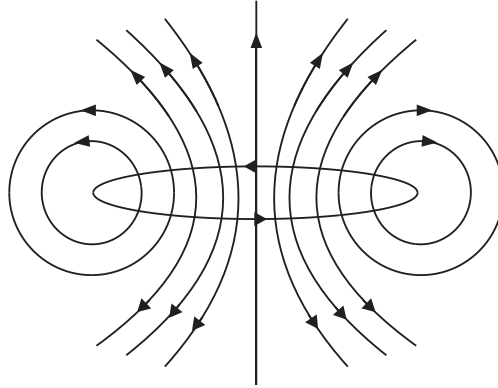

(c) **Magnetic field due to a current carrying element.**

$$dB = \frac{\mu_0 I dl r \sin \theta}{4 r^3}$$

(i) For straight segments $\theta = 0$ or π

$$dl \sin \theta = dl \sin 0 = 0$$

$$B_1 = 0$$

(ii) For semicircular arc $\theta = \frac{\pi}{2}$, $dl = r d\theta$

$$B_2 = \int \frac{\mu_0 I dl r \sin \frac{\pi}{2}}{4 r^3} = \frac{\mu_0 I}{4 r^2} \int dl \sin \frac{\pi}{2} = \frac{\mu_0 I}{4 r^2} \int dl = \frac{\mu_0 I}{4 r^2} \int_0^{\pi} r d\theta = \frac{\mu_0 I r}{4 r^2} \int_0^{\pi} d\theta = \frac{\mu_0 I}{4 r} \int_0^{\pi} d\theta = \frac{\mu_0 I}{4 r} \pi$$

directed perpendicular to plane of paper downward.

29. $R = 400 \Omega$, $L = \frac{5}{100} \text{ H}$, $C = \frac{50}{10^6} \text{ F}$

$$E = 140 \sin 140 t$$

Comparing with $V = V_0 \sin \omega t$, we get

$$V_0 = 140 \text{ V}, \quad \omega = 140 \text{ rad/s}, \quad n = \frac{\omega}{2\pi} = \frac{140}{2\pi} \approx 22.3 \text{ Hz}$$

$$n = 50 \text{ Hz}$$

$$V_{rms} = \frac{V_0}{\sqrt{2}} = \frac{140}{\sqrt{2}} \approx 99 \text{ V}$$

Inductive reactance $X_L = \omega L = 140 \times \frac{5}{100} = 7 \Omega$

Capacitive reactance, $X_C = \frac{1}{C} = \frac{1}{100 \times \frac{50}{10^6}} = 200$

Impedance $Z = \sqrt{R^2 + (X_L - X_C)^2} = \sqrt{(400)^2 + (500 - 200)^2} = 500$

rms current in circuit, $I = \frac{V_{rms}}{Z} = \frac{100}{500} = 0.2 \text{ A}$

Voltage across resistor, $V_R = RI = 400 \times 0.2 = 80 \text{ V}$

Voltage across inductor, $V_L = X_L I = 500 \times 0.2 = 100 \text{ V}$

Voltage across capacitor, $V_C = X_C I = 200 \times 0.2 = 40 \text{ V}$

Algebraic sum of voltages = 80 + 100 - 40 = 160 V

Yes algebraic sum of voltages (160 V) is more than the source voltage (100 V).

This is because V_R and $(V_L - V_C)$ are not in phase but $(V_L - V_C)$ leads V_R by an angle $\frac{\pi}{2}$

$$V = \sqrt{V_R^2 + (V_L - V_C)^2} = \sqrt{(80)^2 + (60)^2} = 100 \text{ V}$$

This resolves the paradox.

OR

- (a) **Eddy Currents:** When a conductor is placed in a varying magnetic field the magnetic flux linked with the conductor changes, so induced currents are induced in the body of conductor, which causes heating of conductor. The currents induced in the conductor are called the **eddy currents**. In varying magnetic field, the free electrons of conductor experience Lorentz force and traverse closed paths; which are equivalent to small current loops. These currents are the eddy currents; they cause heating effect and sometimes the conductor becomes red-hot.

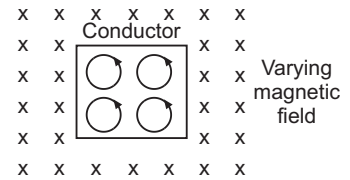

Eddy current losses may be reduced by using laminated soft iron cores in galvanometers, transformers, etc. and making holes in conductor.

- (b) Given $V_p = 2.5 \text{ kV} = 2.5 \times 10^3 \text{ V}$, $I_p = 20 \text{ A}$

Input power, $P_{in} = V_p I_p = 2.5 \times 10^3 \times 20 = 50 \times 10^3 \text{ W} = 50 \text{ kW}$

Turn ratio, $r = \frac{V_s}{V_p} = \frac{1}{10}$, Efficiency = 90% = 0.9

(i) $\frac{P_{out}}{P_{in}}$

Power output, $P_{out} = P_{in} \times 0.9 = 50 \text{ kW} \times 0.9 = 45 \text{ kW}$

(ii) Voltage across secondary $V_s = r V_p = \frac{1}{10} \times 2.5 \times 10^3 \text{ V} = 250 \text{ V}$

(iii) Current in secondary $I_s = \frac{P_{out}}{V_s} = \frac{45 \times 10^3}{250} = 180 \text{ A}$

30. (a) I-V Characteristics of Zener diode:

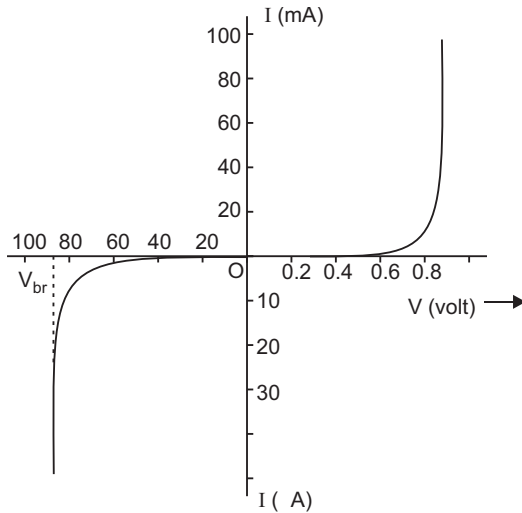

(b) **Zener diode as a Voltage Regulator**

The Zener diode makes its use as a voltage regulator due to the following property :

When a Zener diode is operated in the breakdown region, the voltage across it remains practically constant for a large change in the current.

A simple circuit of a voltage regulator using a Zener diode is shown in the Fig. The Zener diode is connected across load such that it is reverse biased.

The series resistance R absorbs the output voltage fluctuations so as to maintain constant voltage across the load.

The operation of the circuit may be explained as follows :

Let V_{in} be the unregulated input dc voltage and V_0 be the output voltage across R_L to be regulated and V_Z be the Zener voltage of the diode. The value of the series resistance is so chosen that the diode operates in the breakdown region under the Zener voltage V_Z across it.

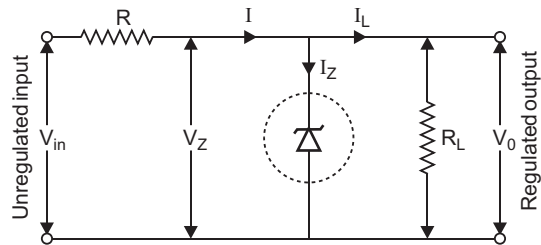

Let I be the current drawn from supply, I_Z the current through Zener diode and I_L the current through load. Then obviously

$$I = I_Z + I_L \text{ or } I_Z = I - I_L$$

If R_Z is Zener diode resistance, then

$$V_0 = V_Z + I_Z R_Z = V_Z + (I - I_L) R_Z$$

Applying Kirchhoff's law to the mesh containing resistance R , Zener diode and supply voltage V_{in} , we have

$$i.e., \quad \frac{RI}{V_Z} = \frac{V_{in} - V_Z}{V_{in}} \quad \dots(i)$$

When the input voltage V_{in} is lower than the Zener voltage V_Z of diode, there is no current conduction

$$i.e., \quad I_Z = 0.$$

$$\text{This implies} \quad V_0 = V_{in}.$$

As input voltage V_{in} is increased so that it becomes equal to V_Z , the breakdown point is reached and the voltage across the diode V_Z ($V_{in} - RI$) becomes constant.

A further increase of input voltage V_{in} does not result in the corresponding increase in V_0 or V_Z but merely increases the voltage drop across R .

Thus in breakdown region, we have

$$V_0 = V_Z + V_{in} - RI$$

Fig. represents the plot of output voltage V_0 versus input voltage V_{in} . It is clear from the graph that the output voltage remains constant when the diode is in Zener region.

It may be pointed out that for maintaining constant regulated output, the series resistance R for a given range of input voltage be so chosen that

- (i) the diode operates in Zener region and
- (ii) current should not exceed a certain value to cause burn out of diode.

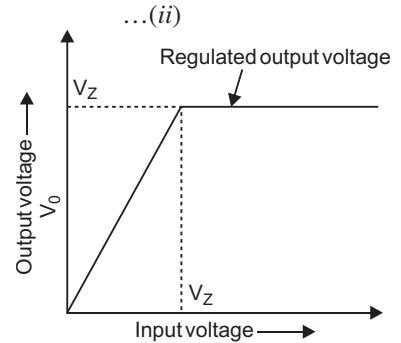

- (c) A photodiode is used in reverse bias, although in forward bias current is more, then current in reverse bias because in reverse bias it is easier to observe change in current with change in light intensity.

OR

(b) (i) Output resistance $r_0 = \frac{V_{CE}}{I_C}$ I_B constant

Taking $I_B = 60 \mu\text{A}$ constant

For $V_{CE} = (16 - 4) \text{ V} = 12 \text{ V}$

Corresponding $I_C = (8.5 - 8) \text{ mA} = 0.5 \text{ mA}$

$$r_0 = \frac{12}{0.5 \times 10^{-3}} = 24 \times 10^3 = \mathbf{24 \text{ k}}$$

(ii) Current amplification factor

$$a_c = \frac{I_C}{I_B} \quad V_{CE} \text{ constant}$$

Taking $V_{CE} = 8 \text{ V}$, $I_C = (5.8 - 3.8) \text{ mA} = 2 \text{ mA}$

$I_B = (40 - 30) \mu\text{A} = 10 \mu\text{A}$

$$a_c = \frac{2 \text{ mA}}{10 \mu\text{A}} = \frac{2 \times 10^{-3}}{10 \times 10^{-6}} = \mathbf{200}$$

CBSE (Foreign) SET-II

- 4. (i) anticlockwise (ii) clockwise
- 8. γ -rays.

Frequency range 10^{19} Hz— 10^{22} Hz.

- 10. Infrared rays produced by hot bodies and molecules. These waves are used for long distance photography and for therapeutic purposes.
- 11. Working of meter bridge is based on Wheatstone bridge. The error may be minimised by taking balancing length near the middle of the bridge.
- 12. Trajectories are shown in fig.

$$r = \frac{mv}{qB}$$

Ratio of radii of electron path and proton path.

$$\frac{r_e}{r_p} = \frac{m_e}{m_p}$$

As mass of proton $m_p = 1840$ mass of electron (m_e)

$$\frac{m_e}{m_p} = \frac{1}{1840}$$

$$\frac{r_e}{r_p} = \frac{1}{1840}$$

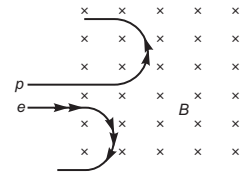

- 13. The output $Y = \overline{A \cdot B} = \overline{\overline{A} \cdot \overline{B}}$

That is equivalent gate is 'AND' gate.

The symbol and truth table are shown in fig.

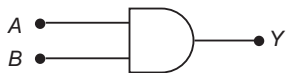

Truth Table

A	B	Y
0	0	0
1	0	0
0	1	0
1	1	1

- 18. **Myopia or shortsightedness:** Myopia is the defect of eye in which a person can see only nearby objects, but fails to see the far away objects distinctly. This defect is due to

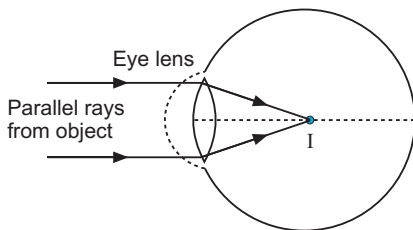

(a) Image formation by myopic eye

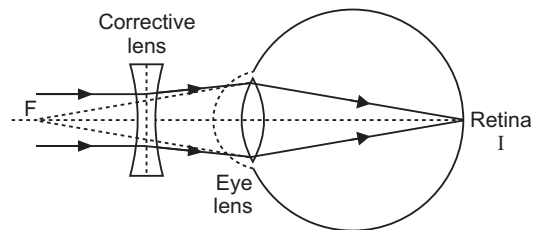

(b) Corrected myopia

- (a) decrease in focal length of the eye lens.
- (b) spreading of the eye-sphere.

Due to these reasons the image is formed in front of the retina.

Remedy: To eliminate this defect a concave lens of suitable focal length is used. The equivalent focal length of concave lens and eye lens should be increased to a value such that the distinct image of far away objects is formed at the retina. If a myopic eye has a far point at F , then the parallel rays from infinity will be incident on concave lens and form its virtual image at F . This image will act as an object for eye lens and the final image (I) will be formed at the retina [Fig (b)]. Clearly, for elimination of myopia **the focal length of corrective concave lens will be equal to the distance of far point of myopic eye from the eye lens.**

21. Net emf of circuit $E = E_2 - E_1 = 9 - 5 = 4V$

Net resistance of circuit,

$$R_{eq} = 4 + 5 + \frac{6 \times 3}{6 + 3} = 10 + 2 = 12 \Omega$$

Current in circuit, $I = \frac{E}{R} = \frac{4}{12} = \frac{1}{3} \text{ A}$

Potential difference across parallel combination of 3 Ω and 6 Ω

$$V = IR = \frac{1}{3} \times 2 = \frac{2}{3} \text{ V}$$

Current in $R_1 = 3 \Omega$ resistance

$$I_1 = \frac{V}{R_1} = \frac{2/3}{3} = \frac{2}{9} \text{ A}$$

22. (b) $C_1 = C, C_2 = 2C$

In series combination of C_1 and C_2 , equivalent capacitance

$$C_s = \frac{C_1 C_2}{C_1 + C_2} = \frac{C \times 2C}{C + 2C} = \frac{2}{3} C$$

In parallel combination of C_1 and C_2 , equivalent capacitance,

$$C_p = C_1 + C_2 = C + 2C = 3C$$

Energy stored, $U_{series} = \frac{1}{2} C_s V_s^2$

$$U_{parallel} = \frac{1}{2} C_p V_p^2$$

Given $U_{series} = U_{parallel}$

$$\frac{1}{2} C_s V_s^2 = \frac{1}{2} C_p V_p^2$$

$$\frac{V_p}{V_s} = \sqrt{\frac{C_s}{C_p}} = \sqrt{\frac{2C/3}{3C}} = \frac{2}{9}$$

23. (a) No change. The focal length of a concave mirror does not depend on the nature of the medium.

(b) Given, $f_a = 10$ cm, $n_g = 1.5$, $n_l = 1.33$

$$f_e = \frac{n_g}{n_l} \frac{1}{f_a} = \frac{1.5}{1.33} \frac{1}{10} \text{ cm}$$

$$= \frac{0.5}{1.33} \frac{10}{1} \text{ cm} = 39.12 \text{ cm}$$

CBSE (Foreign) SET-III

5. γ -rays

Frequency range 10^{19} Hz— 10^{22} Hz.

6. Direction of induced current in loop is **clockwise**.

Reason: Induced current opposes the motion of loop away from wire; as similar currents attracts, so in nearer side of loop the current will be upward *i.e.*, in loop current in clockwise.

9. Output waveform is shown in fig.

Y \overline{AB}

The gate is **NAND** gate.

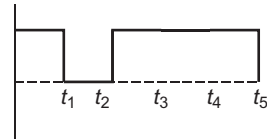

14. The paths of proton (p) and deuteron (d) are shown in figure.

Radius, $r = \frac{mv}{qB}$

$$r_p = \frac{m_p v}{eB}$$

$$r_d = \frac{m_d v}{eB}$$

$$\frac{r_p}{r_d} = \frac{m_p}{m_d} \frac{1}{2}$$

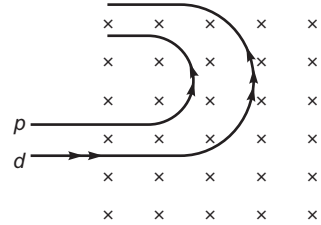

13. Microwaves are produced by special vacuum tubes, namely; klystrons, magnetrons and gunn diodes. Their frequency range is 3 GHz to 300 GHz.

They are used in radar systems used in air craft navigation and microwave users in houses.

15. **Farsightedness or Hypermetropia:** Hypermetropia is the defect of eye in which a person can see only farther objects but fails to see nearer objects distinctly. This defect is due to

- (a) Increase in focal length of eye lens. (b) Contraction of eye-sphere.

Due to these reasons the image of a nearby object is formed behind the retina.

Remedy: The near point of hypermetropic eye is displaced from $D = 25$ cm to some distant point.

To eliminate this defect a convex lens of suitable focal length is used. The equivalent focal length of corrective convex lens and eye lens should be decreased to a value such that the distinct image of nearby objects is formed at the retina.

Suppose the near point of a normal eye is at N and that of a hypermetropic eye is at O . The corrective convex lens forms the image of near point (N) at point O , then this image will act as the

object for eye lens and the final image (I) will be formed at the retina. Therefore the corrective lens enables to form the distinct image of near point (N) at retina.

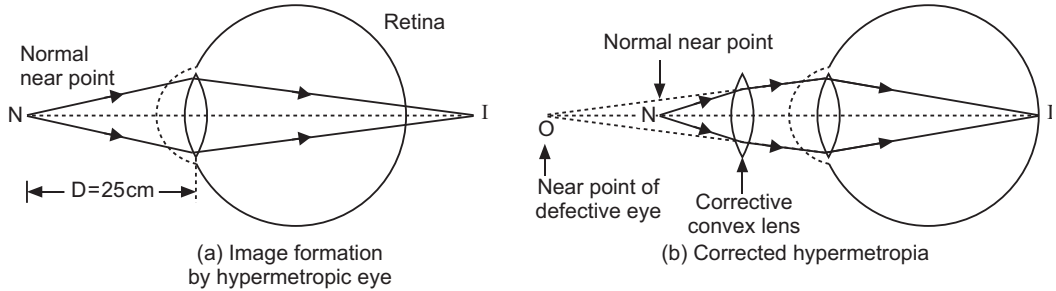

19. (b) Let $C_1 = C, C_2 = 3C$

In series combination $C_s = \frac{C_1 C_2}{C_1 + C_2} = \frac{C \cdot 3C}{C + 3C} = \frac{3C}{4}$

In parallel combination, $C_p = C_1 + C_2 = C + 3C = 4C$

Given $U_s = U_p$

$$\frac{1}{2} C_s V_s^2 = \frac{1}{2} C_p V_p^2$$

$$\frac{V_p}{V_s} = \sqrt{\frac{C_s}{C_p}} = \sqrt{\frac{3C/4}{4C}} = \frac{3}{16}$$

20. In steady state there is no current in capacitor branch, so equivalent circuit is shown in fig.

Net resistance of circuit,

$$R_{eq} = \frac{2 \cdot 3}{2 + 3} + 2.8 = 1.2 + 2.8 = 4 \Omega$$

Net emf, $E = 6 \text{ V}$

Current in circuit, $I = \frac{E}{R_{eq}} = \frac{6}{4} = 1.5 \text{ A}$

Potential difference across parallel combination of 2 Ω and 3 Ω resistances.

$$V = IR = 1.5 \cdot 1.2 = 1.8 \text{ V}$$

Current in $R_1 = 2 \Omega$ resistance

$$I_1 = \frac{V}{R_1} = \frac{1.8}{2} = 0.9 \text{ A}$$

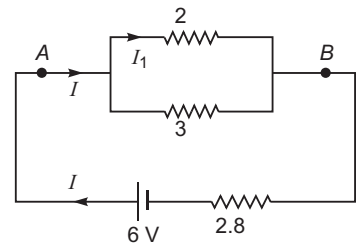

CBSE EXAMINATION PAPERS

DELHI-2011

Time allowed: 3 hours

Maximum marks: 70

General Instructions:

- All questions are compulsory.
- There are 30 questions in total. Questions 1 to 8 carry one mark each, questions 9 to 18 carry two marks each, questions 19 to 27 carry three marks each and questions 28 to 30 carry five marks each.
- There is no overall choice. However, an internal choice has been provided in one question of two marks, one question of three marks and all three questions of five marks each. You have to attempt only one of the given choices in such questions.
- Use of calculators is not permitted.
- You may use the following values of physical constants wherever necessary:

$$c = 3 \times 10^8 \text{ ms}^{-1}$$

$$h = 6.626 \times 10^{-34} \text{ Js}$$

$$e = 1.602 \times 10^{-19} \text{ C}$$

$$\mu_0 = 4\pi \times 10^{-7} \text{ TmA}^{-1}$$

$$\frac{1}{4\epsilon_0} = 9 \times 10^9 \text{ Nm}^2\text{C}^{-2}$$

$$\text{Boltzmann's constant } k = 1.381 \times 10^{-23} \text{ JK}^{-1}$$

$$\text{Avogadro's number } N_A = 6.022 \times 10^{23} / \text{mole}$$

$$\text{Mass of neutron } m_n = 1.675 \times 10^{-27} \text{ kg}$$

$$\text{Mass of electron } m_e = 9.1 \times 10^{-31} \text{ kg}$$

$$\text{Radius of earth} = 6400 \text{ km}$$

CBSE (Delhi) SET-I

- A point charge Q is placed at point O as shown in the figure. Is the potential difference $V_A - V_B$ positive, negative, or zero, if Q is (i) positive (ii) negative?

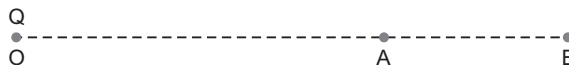

- A plane electromagnetic wave travels in vacuum along z-direction. What can you say about the direction of electric and magnetic field vectors?
- A resistance R is connected across a cell of emf \mathcal{E} and internal resistance r . A potentiometer now measures the potential difference between the terminals of the cell as V . Write the expression for ' r ' in terms of \mathcal{E} , V and R .
- The permeability of a magnetic material is 0.9983. Name the type of magnetic materials it represents.
- Show graphically, the variation of the de-Broglie wavelength (λ) with the potential (V) through which an electron is accelerated from rest.

6. In a transistor, doping level in base is increased slightly. How will it affect (i) collector current and (ii) base current?
7. Define the term 'wattless current'.
8. When monochromatic light travels from one medium to another, its wavelength changes but frequency remains the same. Explain.
9. Two uniformly large parallel thin plates having charge densities $+$ and $-$ are kept in the X-Z plane at a distance ' d ' apart. Sketch an equipotential surface due to electric field between the plates. If a particle of mass m and charge ' $-q$ ' remains stationary between the plates, what is the magnitude and direction of this field?

OR

Two small identical electrical dipoles AB and CD , each of dipole moment ' p ' are kept at an angle of 120° as shown in the figure. What is the resultant dipole moment of this combination? If this system is subjected to electric field (\vec{E}) directed along $+X$ direction, what will be the magnitude and direction of the torque acting on this?

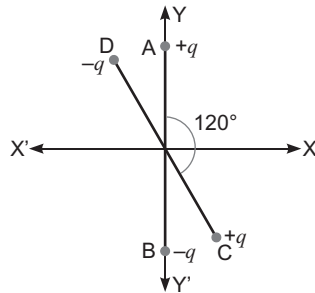

10. A magnetic needle free to rotate in a vertical plane parallel to the magnetic meridian has its north tip down at 60° with the horizontal. The horizontal component of the earth's magnetic field at the place is known to be 0.4 G. Determine the magnitude of the earth's magnetic field at the place.
11. Figure shows two identical capacitors, C_1 and C_2 , each of 1 F capacitance connected to a battery of 6 V. Initially switch ' S ' is closed. After sometimes ' S ' is left open and dielectric slabs of dielectric constant $K = 3$ are inserted to fill completely the space between the plates of the two capacitors. How will the (i) charge and (ii) potential difference between the plates of the capacitors be affected after the slabs are inserted?

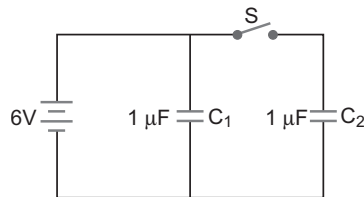

12. Two convex lenses of same focal length but of aperture A_1 and A_2 ($A_2 < A_1$), are used as the objective lenses in two astronomical telescopes having identical eyepieces. What is the ratio of their resolving power? Which telescope will you prefer and why? Give reason.

13. Draw the output waveform at X, using the given inputs A and B for the logic circuit shown below. Also, identify the logic operation performed by this circuit.

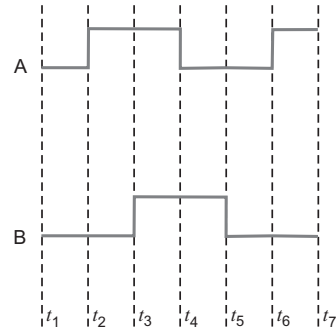
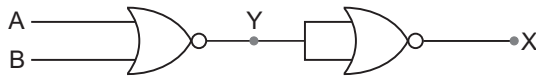

14. Name the semiconductor device that can be used to regulate an unregulated dc power supply. With the help of I - V characteristics of this device, explain its working principle.
15. How are infrared waves produced? Why are these referred to as ‘heat waves’? Write their one important use.
16. Draw the transfer characteristic curve of a base biased transistor in CE configuration. Explain clearly how the active region of the V_o versus V_i curve in a transistor is used as an amplifier.
17. (i) Define modulation index.
(ii) Why is the amplitude of modulating signal kept less than the amplitude of carrier wave?
18. A current is induced in coil C_1 due to the motion of current carrying coil C_2 . (a) Write any two ways by which a large deflection can be obtained in the galvanometer G. (b) Suggest an alternative device to demonstrate the induced current in place of a galvanometer.

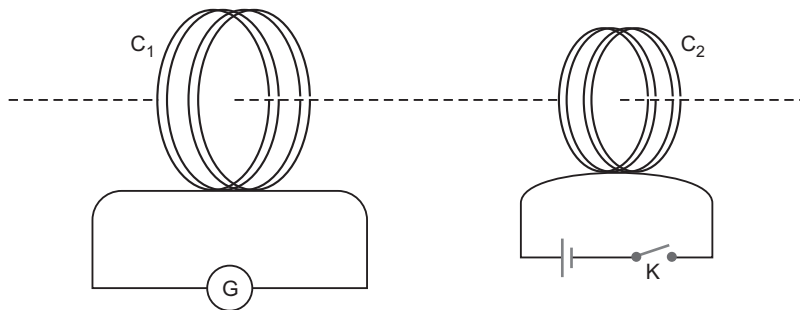

19. Define the terms (i) drift velocity, (ii) relaxation time.
A conductor of length L is connected to a dc source of emf \mathcal{E} . If this conductor is replaced by another conductor of same material and same area of cross-section but of length $3L$, how will the drift velocity change?
20. Using Gauss’s law obtain the expression for the electric field due to a uniformly charged thin spherical shell of radius R at a point outside the shell. Draw a graph showing the variation of electric field with r , for $r > R$ and $r < R$.
21. An electron and a photon each have a wavelength 1.00 nm . Find
(i) their momenta,

- (ii) the energy of the photon and
- (iii) the kinetic energy of electron

22. Draw a schematic diagram showing the (i) ground wave (ii) sky wave and (iii) space wave propagation modes for em waves.

Write the frequency range for each of the following:

- (i) Standard AM broadcast
- (ii) Television
- (iii) Satellite communication

23. Describe Young’s double slit experiment to produce interference pattern due to a monochromatic source of light. Deduce the expression for the fringe width.

OR

Use Huygen’s principle to verify the laws of refraction.

24. (a) Describe briefly, with the help of suitable diagram, how the transverse nature of light can be demonstrated by the phenomenon of polarization.
 (b) When unpolarized light passes from air to a transparent medium, under what condition does the reflected light get polarized?
25. The energy levels of a hypothetical atom are shown below. Which of the shown transitions will result in the emission of a photon of wavelength 275 nm?
 Which of these transitions correspond to emission of radiation of (i) maximum and (ii) minimum wavelength?

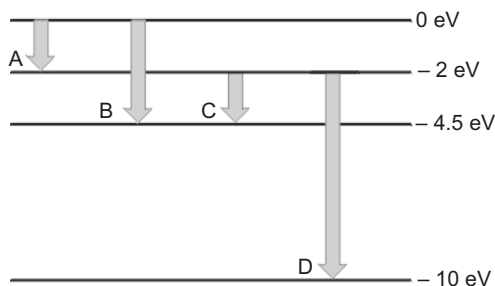

26. State the law of radioactive decay.

Plot a graph showing the number (N) of undecayed nuclei as a function of time (t) for a given radioactive sample having half life $T_{1/2}$. Depict in the plot the number of undecayed nuclei at (i) $t = 3T_{1/2}$ and (ii) $t = 5T_{1/2}$.

27. In the circuit shown, $R_1 = 4$, $R_2 = R_3 = 15$, $R_4 = 30$ and $E = 10$ V. Calculate the equivalent resistance of the circuit and the current in each resistor.

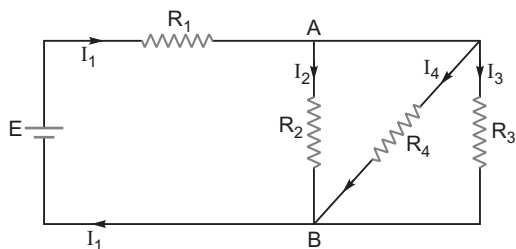

28. State Biot-Savart law, giving the mathematical expression for it.
Use this law to derive the expression for the magnetic field due to a circular coil carrying current at a point along its axis.
How does a circular loop carrying current behave as a magnet?

OR

With the help of a labelled diagram, state the underlying principle of a cyclotron. Explain clearly how it works to accelerate the charged particles.
Show that cyclotron frequency is independent of energy of the particle. Is there an upper limit on the energy acquired by the particle? Give reason.

29. (a) Draw a ray diagram to show refraction of a ray of monochromatic light passing through a glass prism.
Deduce the expression for the refractive index of glass in terms of angle of prism and angle of minimum deviation.
(b) Explain briefly how the phenomenon of total internal reflection is used in fibre optics.

OR

- (a) Obtain lens makers formula using the expression

$$\frac{n_2}{v} - \frac{n_1}{u} = \frac{(n_2 - n_1)}{R}$$

Here the ray of light propagating from a rarer medium of refractive index (n_1) to a denser medium of refractive index (n_2), is incident on the convex side of spherical refracting surface of radius of curvature R .

- (b) Draw a ray diagram to show the image formation by a concave mirror when the object is kept between its focus and the pole. Using this diagram, derive the magnification formula for the image formed.
30. (i) With the help of a labelled diagram, describe briefly the underlying principle and working of a step up transformer.
(ii) Write any two sources of energy loss in a transformer.
(iii) A step up transformer converts a low input voltage into a high output voltage. Does it violate law of conservation of energy? Explain.

OR

Derive an expression for the impedance of a series LCR circuit connected to an AC supply of variable frequency.

Plot a graph showing variation of current with the frequency of the applied voltage.

Explain briefly how the phenomenon of resonance in the circuit can be used in the tuning mechanism of a radio or a TV set.

CBSE (Delhi) SET-II

Questions uncommon to Set-I

2. The susceptibility of a magnetic material is 1.9×10^{-5} . Name the type of magnetic materials it represents.

4. A plane electromagnetic wave travels in vacuum along x -direction. What can you say about the direction of electric and magnetic field vectors?
10. A magnet is quickly moved in the direction indicated by an arrow between two coils C_1 and C_2 as shown in the figure. What will be the direction of induced current in each coil as seen from the magnet? Justify your answer.

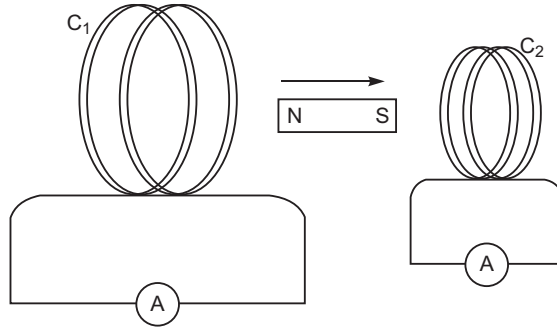

11. Figure shows two identical capacitors C_1 and C_2 each of 1 F capacitance, connected to a battery of 5 V . Initially switch 'S' is closed. After some time 'S' is left open and dielectric slabs of dielectric constant $K = 5$ are inserted to fill completely the space between the plates of the two capacitors. How will the (i) charge and (ii) potential difference between the plates of the capacitors be affected after the slabs are inserted?

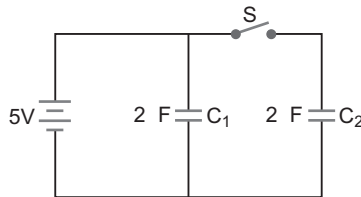

13. Draw the output wave form at X , using the given inputs A and B for the logic circuit shown below. Also, identify the logic operation performed by this circuit.

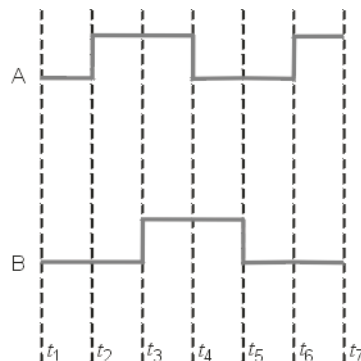
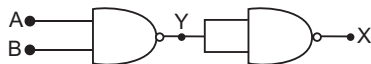

16. How is forward biasing different from reverse biasing in a p-n junction diode?

20. In the circuit shown, $R_1 = 4$, $R_2 = R_3 = 5$, $R_4 = 10$ and $E = 6$ V. Work out the equivalent resistance of the circuit and the current in each resistor.

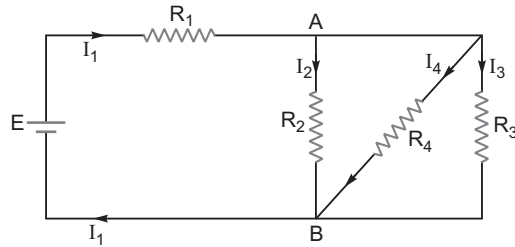

23. An electron and a photon each have a wave length of 1.50 nm. Find (i) their momenta, (ii) the energy of the photon and (iii) kinetic energy of the electron.
24. State the law of radioactive decay.
 Plot a graph showing the number (N) of undecayed nuclei as a function of time (t) for a given radioactive sample having half life $T_{\frac{1}{2}}$.
 Depict in the plot the number of undecayed nuclei at (i) $t = 2 T_{\frac{1}{2}}$ and (ii) $t = 4T_{\frac{1}{2}}$.

CBSE (Delhi) SET-III

Questions uncommon to Set-I & II

2. A plane electromagnetic wave travels in vacuum along y -direction. What can you say about the direction of electric and magnetic field vectors?
7. The susceptibility of a magnetic materials is -4.2×10^{-6} . Name the type of magnetic materials it represents.
9. Explain how a depletion region is formed in a junction diode.
14. Figure shows two identical capacitors C_1 and C_2 each of $1.5 \mu\text{F}$ capacitance, connected to a battery of 2 V. Initially switch 'S' is closed. After sometimes 'S' is left open and dielectric slabs of dielectric constant $K = 2$ are inserted to fill completely the space between the plates of the two capacitors. How will the (i) charge and (ii) potential difference between the plates of the capacitors be affected after the slabs are inserted?

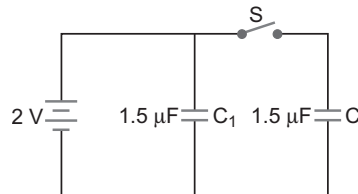

16. Write the truth table for the logic circuit shown below and identify the logic operation performed by this circuit.

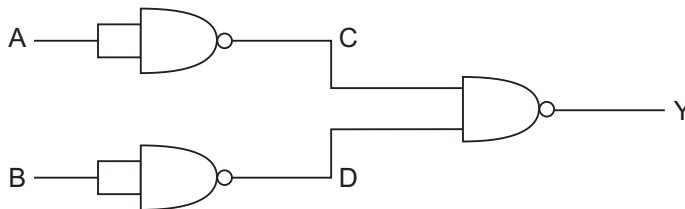

17. Predict the polarity of the capacitor when the two magnets are quickly moved in the directions marked by arrows.

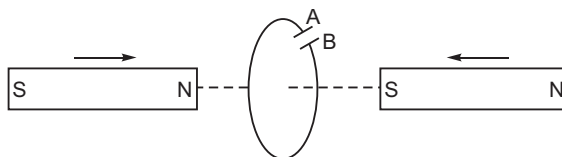

23. In the circuit shown, $R_1 = 2 \Omega$, $R_2 = R_3 = 10 \Omega$, $R_4 = 20 \Omega$ and $E = 6 \text{ V}$. Work out the equivalent resistance of the circuit and the current in each resistor.

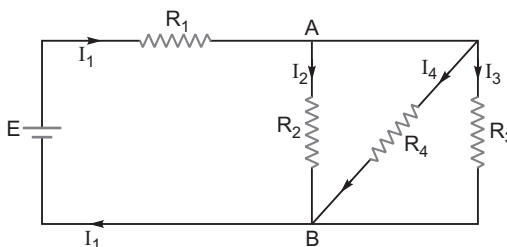

25. An electron and a photon each have a wavelength of 2 nm . Find
- their momenta
 - the energy of the photon
 - the kinetic energy of the electron.

Solutions

CBSE (Delhi) SET-I

- The potential due to a point charge decreases with increase of distance. So, in case (i) $V_A - V_B$ is positive.
For case (ii) $V_A - V_B$ is negative.
- Electric field vector along X-axis
Magnetic field vector along Y-axis.
- $r = \frac{1}{V} = 1/R$
- $r < 1$, so magnetic material is diamagnetic.
- $\frac{1}{V}$, so graph is shown in figure below.

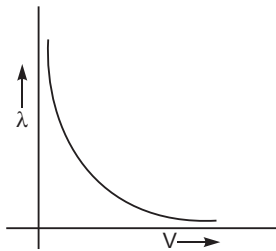

- When doping level in base is increased slightly, (i) collector current decreases slightly and (ii) base current increases slightly.
- Current flowing in an ac circuit without any net dissipation of power is called wattless current.
- When monochromatic light travels from one medium to another its wavelength and speed both change such that

$$\frac{v_1}{1} = \frac{v_2}{2} \quad \text{frequency}$$

so frequency remains unchanged.

- The equipotential surface is at a distance $d/2$ from either plate in X-Z plane. For a particle of charge $(-q)$ at rest between the plates, then
 - weight mg acts, vertically downward
 - electric force qE acts vertically upward.
 so $mg = qE$

$$E = \frac{mg}{q}, \text{ vertically downward, i.e., along } (-) \text{ Y-axis.}$$

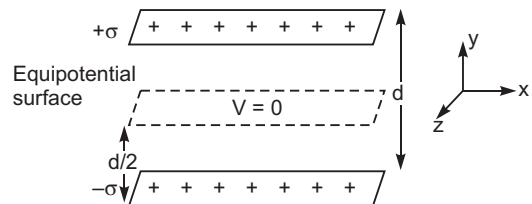

OR

Resultant dipole moment

$$p_r = \sqrt{p^2 + p^2 + 2pp \cos 120^\circ}$$

$$= \sqrt{2p^2 + 2p^2 \cos 120^\circ}$$

$$= \sqrt{2p^2 - (2p^2)} = \frac{1}{2}$$

$$\sqrt{2p^2 - p^2} = p,$$

making an angle 60° with Y-axis or 30° with X-axis.

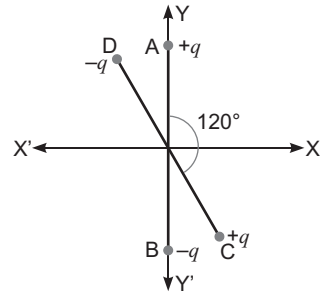

Torque, $\tau = p \times E$ (τ is perpendicular to both p and E)

$$= p E \sin 30^\circ = \frac{1}{2} pE.$$

Direction of torque is along negative Z-direction.

10. Angle of dip, $\theta = 60^\circ$

$$H = 0.4 \text{ G} = 0.4 \times 10^{-4} \text{ T}$$

If B_e is earth's magnetic field, then

$$H = B_e \cos \theta$$

$$B_e = \frac{H}{\cos \theta} = \frac{0.4 \times 10^{-4} \text{ T}}{\cos 60^\circ} = \frac{0.4 \times 10^{-4} \text{ T}}{0.5}$$

$$= 0.8 \times 10^{-4} \text{ T} = 0.8 \text{ G}$$

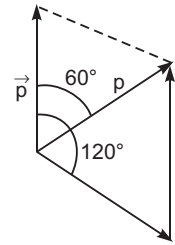

11. When switch S is closed, p.d. across each capacitor is 6 V

$$\begin{matrix} V_1 & V_2 & 6 \text{ V} \\ C_1 & C_2 & 1 \text{ C} \end{matrix}$$

Charge on each capacitor

$$q_1 = q_2 = (C V) = (1 \text{ F}) (6 \text{ V}) = 6 \text{ C}$$

When switch S is opened, the p.d. across C_1 remains 6 V, while the charge on capacitor C_2 remains 6 C. After insertion of dielectric between the plates of each capacitor, the new capacitance of each capacitor becomes

$$C_1 = 3 \text{ F}, C_2 = 3 \text{ F}$$

- (i) Charge on capacitor C_1 , $q_1 = C_1 V_1 = (3 \text{ F}) (6 \text{ V}) = 18 \text{ C}$

Charge on capacitor C_2 remains 6 C

- (ii) Potential difference across C_1 remains 6 V.

Potential difference across C_2 becomes

$$V_2 = \frac{q_2}{C_2} = \frac{6 \text{ C}}{3 \text{ F}} = 2 \text{ V}$$

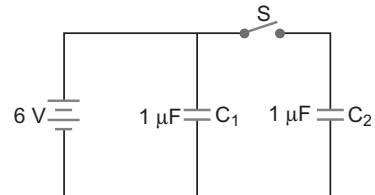

12. Resolving power $R = \frac{A}{122}$, where A is aperture

$$\frac{R_1}{R_2} = \frac{A_1}{A_2}$$

Magnification of telescope, $m = \frac{f_o}{f_e}$ = same for both. We prefer telescope of higher resolving power to view the fine details of the object, *i.e.*, telescope having convex lens of aperture A_1 .

13. $Y = \overline{A \cdot B} = \overline{\overline{A} \cdot \overline{B}} = \overline{\overline{A}} \cdot \overline{\overline{B}} = A \cdot B$

That is logic operation is **OR**.

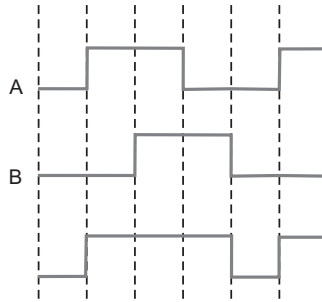

Output Waveform

14. Zener diode can be used to regulate an unregulated dc power supply.

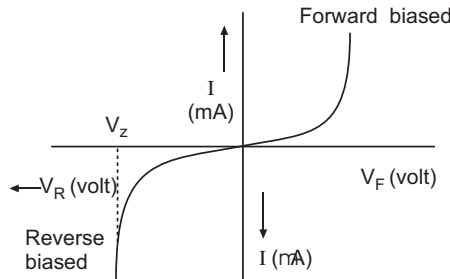

V-I characteristics of zener diode

Principle: In reverse breakdown (zener) region, a very small change in voltage across the zener diode produces a very large change in current through the circuit but the voltage across the zener remains constant.

15. Infrared waves are produced by hot bodies and molecules. They are referred as heat waves because they are readily absorbed by water molecules in most materials, which increases their thermal motion, so they heat up the material.

Use: For therapeutic purpose and long distance photography.

16. In the active region, a small increase of V_i results in a large (almost linear) increase in I_C . This results in an increase in the voltage drop across R_C .

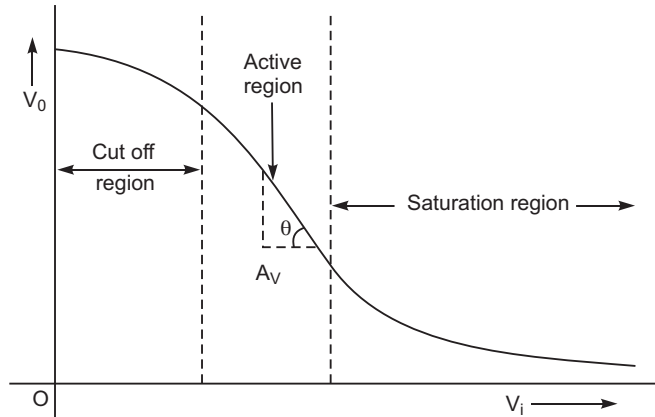

17. (i) **Modulation Index:** The modulation index of an amplitude modulated wave is defined as the ratio of the amplitude of modulating signal (E_m) to the amplitude of carrier wave (E_c) i.e., amplitude modulation index,

$$m_a = \frac{E_m}{E_c}$$

For modulated wave,

$$m_a = \frac{E_{\max} - E_{\min}}{E_{\max} + E_{\min}}$$

$E_m < E_c$, to avoid distortion

- (ii) The amplitude of modulating signal is kept less than the amplitude of carrier wave to **avoid distortion**.
18. (a) The deflection in galvanometer may be made large by
 (i) moving coil C_2 towards C_1 with high speed.
 (ii) by placing a soft iron laminated core at the centre of coil C_1 .
- (b) The induced current can be demonstrated by connecting a torch bulb (in place of galvanometer) in Coil C_1 . Due to induced current the bulb begins to glow.
19. (i) **Drift Velocity:** When a potential difference is applied across a conductor, the free electrons drift towards the direction of positive potential. The small average velocity of free electrons along the direction of positive potential is called the drift velocity.
- (ii) **Relaxation Time:** The time of free travel of a free electron between two successive collisions of electron with lattice ions/atoms is called the **relaxation time**.

$$\text{Drift velocity, } V_d = \frac{e}{m} \frac{1}{L} = \frac{1}{L}$$

When length L is made $3L$, drift velocity becomes **one-third**.

20. Electric field intensity at a point outside a uniformly charged thin spherical shell: Consider a uniformly charged thin spherical shell of radius R carrying charge Q . To find the electric field outside the shell, we consider a spherical Gaussian surface of radius r ($> R$), concentric with given shell. If \mathbf{E} is electric field outside the shell, then by symmetry electric field strength has

same magnitude E_0 on the Gaussian surface and is directed radially outward. Also the directions of normal at each point is radially outward, so angle between \mathbf{E}_i and $d\mathbf{S}$ is zero at each point. Hence, electric flux through Gaussian surface $\oint_S \mathbf{E}_0 \cdot d\mathbf{S}$.

$$\oint_S E_0 dS \cos 0 = E_0 \cdot 4\pi r^2$$

Now, Gaussian surface is outside the given charged shell, so charge enclosed by Gaussian surface is Q .

Hence, by Gauss's theorem

$$\oint_S \mathbf{E}_0 \cdot d\mathbf{S} = \frac{1}{\epsilon_0} \text{charge enclosed}$$

$$E_0 \cdot 4\pi r^2 = \frac{1}{\epsilon_0} Q \quad E_0 = \frac{1}{4\pi\epsilon_0} \frac{Q}{r^2}$$

Thus, **electric field outside a charged thin spherical shell is the same as if the whole charge Q is concentrated at the centre.**

If σ is the surface charge density of the spherical shell, then

$$\sigma = \frac{Q}{4\pi R^2} = \frac{C}{4\pi R^2}$$

$$E_0 = \frac{1}{4\pi\epsilon_0} \frac{4\pi R^2 \sigma}{r^2} = \frac{R^2}{\epsilon_0 r^2} \sigma$$

Electric field inside the shell (hollow charged conducting sphere): The charge resides on the surface of a conductor. Thus a hollow charged conductor is equivalent to a charged spherical shell. To find the electric field inside the shell, we consider a spherical Gaussian surface of radius r ($r < R$), concentric with the given shell. If \mathbf{E} is the electric field inside the shell, then by symmetry electric field strength has the same magnitude E_i on the Gaussian surface and is directed radially outward. Also the directions of normal at each point is radially outward, so angle between \mathbf{E}_i and $d\mathbf{S}$ is zero at each point. Hence, electric flux through Gaussian surface

$$\oint_S \mathbf{E}_i \cdot d\mathbf{S}$$

$$E_i dS \cos 0 = E_i \cdot 4\pi r^2$$

Now, Gaussian surface is inside the given charged shell, so charge enclosed by Gaussian surface is zero.

Hence, by Gauss's theorem

$$\oint_S \mathbf{E}_i \cdot d\mathbf{S} = \frac{1}{\epsilon_0} \text{charge enclosed}$$

$$E_i \cdot 4\pi r^2 = \frac{1}{\epsilon_0} \cdot 0 \quad E_i = 0$$

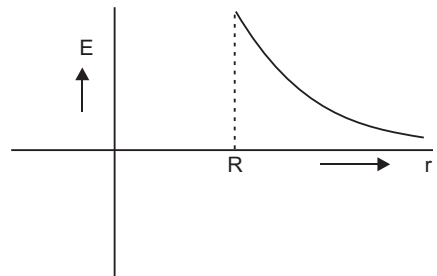
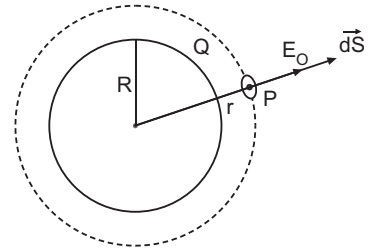

21. Given $1.00 \text{ nm} = 1.00 \times 10^{-9} \text{ m}$

(i) Momenta of electron and photon are equal; given by

$$p = \frac{h}{\lambda} = \frac{6.63 \times 10^{-34}}{1.00 \times 10^{-9}} = 6.63 \times 10^{-25} \text{ kg ms}^{-1}$$

(ii) Energy of photon, $E = hc = \frac{h}{\lambda} \times c$

$$pc = 6.63 \times 10^{-25} \times 3 \times 10^8 \text{ J} = 1.989 \times 10^{-17} \text{ J}$$

$$\frac{1.989 \times 10^{-17}}{1.6 \times 10^{-19}} \text{ eV} = 1.24 \times 10^3 \text{ eV} = 1.24 \text{ keV}$$

(iii) Kinetic energy of electron $E_k = \frac{1}{2} m_e v^2 = \frac{p^2}{2m_e}$

$$\frac{(6.63 \times 10^{-25})^2}{2 \times 9.1 \times 10^{-31}} \text{ J}$$

$$2.42 \times 10^{-19} \text{ J} = \frac{2.42 \times 10^{-19}}{1.6 \times 10^{-19}} \text{ eV} = 1.51 \text{ eV}$$

22.

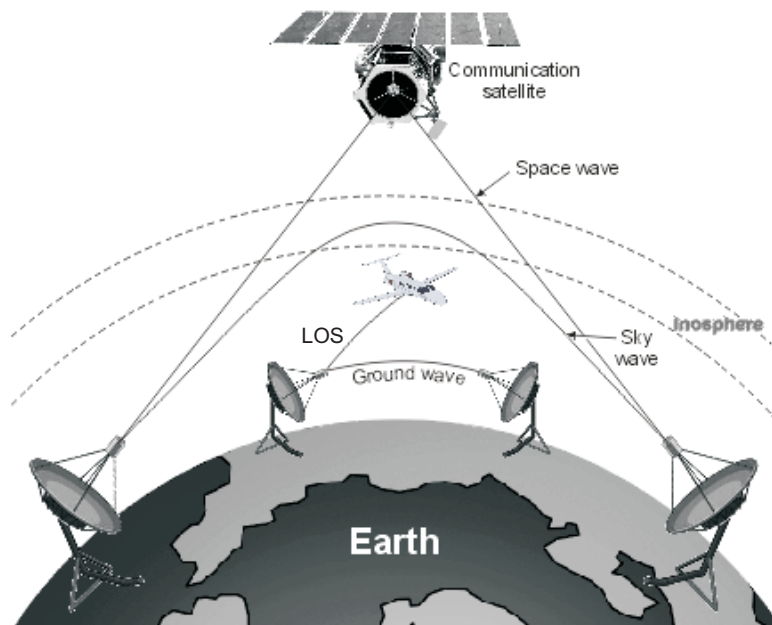

Three propagation modes of em waves

Frequency Range of Different Services

(i) Standard AM broadcast 540–1600 kHz

- (ii) Television 54–890 MHz
- (iii) Satellite Communication 5.925–6.425 GHz uplink
3.7–4.2 GHz downlink.

23. Young’s Double slit experiment:

Coherent sources are those which have exactly the same frequency and are in this same phase or have a constant difference in phase.

Conditions: (i) The sources should be monochromatic and originating from common single source.
(ii) The amplitudes of the waves should be equal.

Expression for Fringe Width: Let S_1 and S_2 be two coherent sources separated by a distance d . Let the distance of the screen from the coherent sources be D . Let M be the foot of the perpendicular drawn from O , the midpoint of S_1 and S_2 on the screen. Obviously point M is equidistant from S_1 and S_2 . Therefore the path difference between the two waves at point M is zero. Thus the point M has the maximum intensity. Consider a point P on the screen at a distance y from M . Draw S_1N perpendicular from S_1 on S_2P .

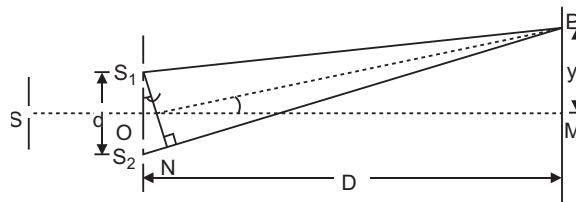

The path difference between two waves reaching at P from S_1 and S_2 is $S_2P - S_1P = S_2N$

As $D \gg d$, therefore S_2N is very small

$$S_2N \approx S_1N \approx MN$$

In $\triangle S_1S_2N$, $\sin \theta = \frac{S_2N}{S_1S_2}$

In $\triangle MOP$, $\tan \theta = \frac{MP}{OM}$

As θ is very small

$$\sin \theta \approx \tan \theta$$

$$\frac{S_2N}{S_1S_2} \approx \frac{MP}{OM}$$

$$S_2N \approx S_1S_2 \frac{MP}{OM} = d \cdot \frac{y}{D}$$

$$\text{Path difference } S_2P - S_1P = S_2N \approx \frac{yd}{D} \quad \dots(i)$$

(i) **Positions of bright fringes (or maxima):** For bright fringe or maximum intensity at P , the path difference must be an integral multiple of wavelength (λ) of light used. *i.e.* $n\lambda$

$$\frac{yd}{D} = n\lambda, n = 0, 1, 2, 3, \dots$$

$$y = \frac{nD}{d}.$$

This equation gives the distance of n th bright fringe from the point M . Therefore writing y_n for y , we get

$$y_n = \frac{nD}{d}. \quad \dots(ii)$$

(ii) **Positions of dark fringes (or minima):** For dark fringe or minimum intensity at P , the path difference must be an odd number multiple of half wavelength. *i.e.* $(2n - 1)\frac{\lambda}{2}$

$$\frac{y \cdot d}{D} = (2n - 1)\frac{\lambda}{2} \text{ where } n = 1, 2, 3, \dots$$

or
$$y = \frac{(2n - 1) D}{2d} = (n - \frac{1}{2})\frac{D}{d}.$$

This equation gives the distance of n th dark fringe from point M . Therefore writing y_n for y , we get

$$y_n = (n - \frac{1}{2})\frac{D}{d} \quad \dots(iii)$$

(iii) **Fringe Width :** The distance between any two consecutive bright fringes or any two consecutive dark fringes is called the **fringe width**. It is denoted by β .

For Bright Fringes: If y_{n-1} and y_n denote the distances of two consecutive bright fringes from M , then we have

$$y_{n-1} = (n - 1)\frac{D}{d} \text{ and } y_n = \frac{nD}{d}$$

$$\text{Fringe width, } \beta = y_n - y_{n-1} = (n - 1)\frac{D}{d} + \frac{nD}{d} - \frac{D}{d}. \quad \dots(iv)$$

For Dark Fringes: If y_{n-1} and y_n are the distances of two consecutive dark fringes from M , then we have

$$y_{n-1} = (n - \frac{1}{2})\frac{D}{d}, y_n = (n - \frac{1}{2})\frac{D}{d}$$

$$\begin{aligned} \text{Fringe width, } \beta &= y_n - y_{n-1} \\ &= (n - \frac{1}{2})\frac{D}{d} - (n - \frac{1}{2})\frac{D}{d} \\ &= \frac{D}{d}(n - \frac{1}{2} - n + \frac{1}{2}) = \frac{D}{d} \end{aligned} \quad \dots(v)$$

Thus, fringe width is the same for bright and dark fringes equal to

$$\frac{D}{d}$$

The condition for the interference fringes to be seen is

$$\frac{s}{b} \geq \frac{\lambda}{d}$$

OR

The assumptions of Huygen’s theory are: (i) A source sends waves in all possible directions. **The locus of particles of a medium vibrating in the same phase is called a wavefront.** From a point source, the wavefront is spherical; while for a line source the wavefront is cylindrical. The distant wavefront is plane.

(ii) Each point of a wavefront acts as a source of secondary wavelets. The envelope of all wavelets at a given instant gives the position of a new wavefront.

Rectilinear Propagation of Light: According to Newton’s corpuscular theory, the path of light is a straight line, but according to wave theory the rectilinear propagation of light is only approximate.

Proof of Snell’s law of Refraction using Huygen’s wave theory: When a wave starting from one homogeneous medium enters the another homogeneous medium, it is deviated from its path. This phenomenon is called **refraction**. In transversing from first medium to another medium, the frequency of wave remains unchanged but its speed and the wavelength both are changed. Let XY be a surface separating the two media ‘1’ and ‘2’. Let v_1 and v_2 be the speeds of waves in these media.

Suppose a plane wavefront AB in first medium is incident obliquely on the boundary surface XY and its end A touches the surface at A at time $t = 0$ while the other end B reaches the surface at point B' after time-interval t . Clearly $BB' = v_1 t$. As the wavefront AB advances, it strikes the points between A and B' of boundary surface. According to Huygen’s principle, secondary spherical wavelets originate from these points, which travel with speed v_1 in the first medium and speed v_2 in the second medium.

First of all secondary wavelet starts from A , which traverses a distance $AA'' (= v_2 t)$ in second medium in time t . In the same time-interval t , the point of wavefront traverses a distance BB' ($= v_1 t$) in first medium and reaches B' , from, where the secondary wavelet now starts. Clearly $BB' = v_1 t$ and $AA'' = v_2 t$.

Assuming A as centre, we draw a spherical arc of radius $AA'' (= v_2 t)$ and draw tangent $A''B''$ on this arc from B' . As the incident wavefront AB advances, the secondary wavelets start from points between A and B' , one after the other and will touch $A''B''$ simultaneously. According to Huygen’s principle $A''B''$ is the new position of wavefront AB in the second medium. Hence $A''B''$ will be the **refracted wavefront**.

First law: As $AB, A''B''$ and surface XY are in the plane of paper, therefore the perpendicular drawn on them will be in the same plane. As the lines drawn normal to wavefront denote the rays, therefore we may say that the incident ray, refracted ray and the normal at the point of incidence all lie in the same plane.

This is the first law of refraction.

Second law: Let the incident wavefront AB and refracted wavefront $A''B''$ make angles i and r respectively with refracting surface XY .

In right-angled triangle $AB'B$, $\angle AB'B = 90^\circ$

$$\sin i = \sin \angle BAB' = \frac{BB'}{AB} = \frac{v_1 t}{AB} \quad \dots(i)$$

Similarly in right-angled triangle $AA''B''$, $\angle AA''B'' = 90^\circ$

$$\frac{\sin r}{\sin i} = \frac{v_1}{v_2} = \text{constant} \quad \dots(ii)$$

Dividing equation (i) by (ii), we get

$$\frac{\sin i}{\sin r} = \frac{v_1}{v_2} = \text{constant} \quad \dots(iii)$$

As the rays are always normal to the wavefront, therefore the incident and refracted rays make angles i and r with the normal drawn on the surface XY i.e. i and r are the angle of incidence and angle of refraction respectively. According to equation (iii):

The ratio of sine of angle of incidence and the sine of angle of refraction is a constant and is equal to the ratio of velocities of waves in the two media. This is the second law of refraction, and is called the Snell's law.

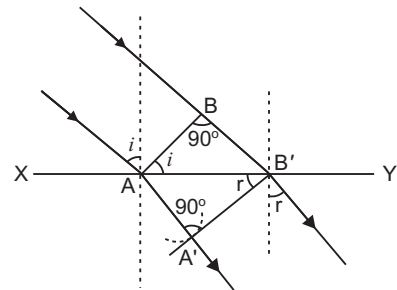

24. (a) Light from a source S is allowed to fall normally on the flat surface of a thin plate of a tourmaline crystal, cut parallel to its axis. Only a part of this light is transmitted through A . If now the plate A is rotated, the character of transmitted light remains unchanged. Now another similar plate B is placed at some distance from A such that the axis of B is parallel to that of A . If the light transmitted through A is passed through B , the light is almost completely transmitted through B and no change is observed in the light coming out of B .

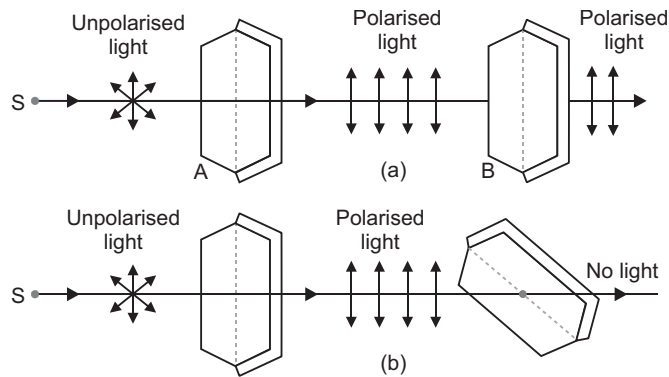

If now the crystal A is kept fixed and B is gradually rotated in its own plane, the intensity of light emerging out of B decreases and becomes zero when the axis of B is perpendicular to that of A . If B is further rotated, the intensity begins to increase and becomes maximum when the axes of A and B are again parallel.

Thus, we see that the intensity of light transmitted through B is maximum when axes of A and B are parallel and minimum when they are at right angles.

From this experiment, it is obvious that light waves are transverse and not longitudinal; because, if they were longitudinal, the rotation of crystal B would not produce any change in the intensity of light.

- (b) The reflected ray is totally plane polarised, when reflected and refracted rays are perpendicular to each other.

25. Energy of photon wavelength 275 nm

$$E = \frac{hc}{\lambda} = \frac{6.63 \times 10^{-34} \times 3 \times 10^8}{275 \times 10^{-9}} \text{ eV} = 4.5 \text{ eV}.$$

This corresponds to transition 'B'.

(i) $E = \frac{hc}{\lambda} = \frac{hc}{E}$

For **maximum wavelength** E should be minimum. This corresponds to transition A.

(ii) For *minimum wavelength* E should be maximum. This corresponds to transition D.

26. The number of nuclei undergoing the decay per unit time, at any instant, is proportional to the total number of nuclei present in the sample at that instant.

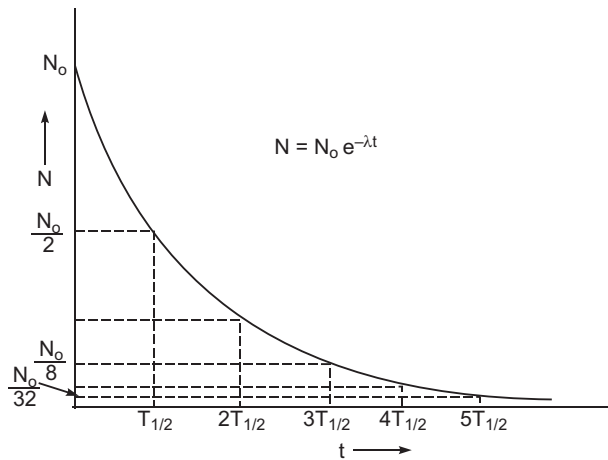

Number of undecayed nuclei at $t = 3T_{1/2}$ is $\frac{N_0}{8}$ and at $t = 5T_{1/2}$, it is $\frac{N_0}{32}$.

27. Given $R_1 = 4 \ \Omega$, $R_2 = R_3 = 15 \ \Omega$, $R_4 = 30 \ \Omega$, $E = 10 \text{ V}$.

Equivalent Resistance:

R_2 , R_3 and R_4 are in parallel, so their effective resistance (R) is given by

$$\frac{1}{R} = \frac{1}{R_2} + \frac{1}{R_3} + \frac{1}{R_4} = \frac{1}{15} + \frac{1}{15} + \frac{1}{30}$$

$$R = 6 \ \Omega$$

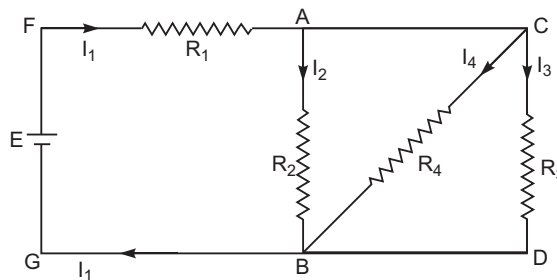

R_1 is in series with R , so equivalent resistance

$$R_{eq} = R + R_1 = 6 + 4 = 10 \text{ } .$$

Currents:

$$I_1 = \frac{E}{R_{eq}} = \frac{10}{10} = 1 \text{ A} \quad \dots(i)$$

This current is divided at A into three parts I_2 , I_3 and I_4 .

$$I_2 + I_3 + I_4 = 1 \text{ A} \quad \dots(ii)$$

Also, $I_2 R_2 = I_3 R_3 = I_4 R_4$

$$I_2 \times 15 = I_3 \times 15 = I_4 \times 30$$

$$I_2 = I_3 = 2I_4 \quad \dots(iii)$$

Substituting values of I_2 , I_3 in (ii), we get

$$2I_4 + 2I_4 + I_4 = 1 \text{ A} \quad I_4 = 0.2 \text{ A}$$

$$I_2 = I_3 = 2 \times 0.2 = 0.4 \text{ A}$$

Thus, $I_1 = 1\text{A}$, $I_2 = I_3 = 0.4\text{A}$ and $I_4 = 0.2\text{A}$

28. Biot-Savart Law

It states that the magnetic field strength (dB) produced due to a current element (of current I and length dl) at a point having position vector r relative to current element is

$$dB = \frac{\mu_0}{4\pi} \frac{I dl \sin \theta}{r^3}$$

where μ_0 is permeability of free space. Its value is $4\pi \times 10^{-7} \text{ Wb/A-m}$.

The magnitude of magnetic field is

$$dB = \frac{\mu_0}{4\pi} \frac{I dl \sin \theta}{r^2}$$

where θ is the angle between current element $I dl$ and position vector r .

The direction of magnetic field dB is perpendicular to the plane containing $I dl$ and r .

Magnetic field at the axis of a circular loop: Consider a circular loop of radius R carrying current I , with its plane perpendicular to the plane of paper. Let P be a point of observation on the axis of this circular loop at a distance x from its centre O . Consider a small element of length l of the coil at point A. The magnitude of the magnetic induction B at point P due to this element is given by

$$B = \frac{\mu_0}{4\pi} \frac{I l \sin \theta}{r^2} \quad \dots(i)$$

The direction of B is perpendicular to the plane containing l and r and is given by right hand screw rule. As the angle between $I l$ and r is 90° , the magnitude of the magnetic induction B is given by,

$$B = \frac{\mu_0 I}{4} \frac{l \sin 90}{r^2} = \frac{\mu_0 I l}{4 r^2} \quad \dots(ii)$$

In figure B has been represented by PQ . The vector B or (PQ) can be resolved into two components, namely PM and PN along and perpendicular to the axis respectively. Now consider another small current element dl of length l at A . The magnetic induction

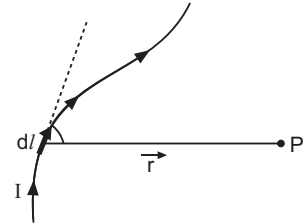

B due to this element has been represented by PQ whose magnitude is $\frac{\mu_0 I l}{4 r^2}$ and which can also be resolved into two

components; PM and PN along the axis and perpendicular to the axis respectively. Thus if we consider the magnetic induction produced by the whole of the circular coil, then by symmetry the components of magnetic induction perpendicular to the axis will be cancelled out, while those parallel to the axis will be added up. Thus the resultant magnetic induction B at axial point P is along the axis and may be evaluated as follows:

The component of B along the axis,

$$B_x = \frac{\mu_0 I l}{4 r^2} \sin \alpha \quad \dots(iii)$$

But $\sin \alpha = \frac{R}{r}$ and $r = (R^2 + x^2)^{1/2}$

$$B_x = \frac{\mu_0 I l}{4 r^2} \frac{R}{r} = \frac{\mu_0 IR}{4 r^3} l$$

$$B_x = \frac{\mu_0 IR}{4 (R^2 + x^2)^{3/2}} l \quad \dots(iv)$$

Therefore the magnitude of resultant magnetic induction at axial point P due to the whole circular coil is given by

$$B = \int \frac{\mu_0 IR}{4 (R^2 + x^2)^{3/2}} dl = \frac{\mu_0 IR}{4 (R^2 + x^2)^{3/2}} \int dl$$

But $\int dl$ length of the loop $= 2\pi R$... (v)

Therefore, $B = \frac{\mu_0 IR}{4 (R^2 + x^2)^{3/2}} (2\pi R)$

$$B = \frac{\mu_0 I R^2}{2 (R^2 + x^2)^{3/2}} \text{ tesla.}$$

If the coil contains N turns, then

$$B = \frac{\mu_0 N I R^2}{2 (R^2 + x^2)^{3/2}} \text{ tesla.} \quad \dots(vi)$$

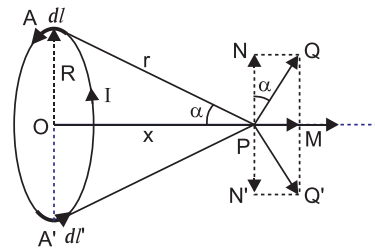

A magnetic needle placed at the center and axis of a circular coil shows deflection. This implies that a circular coil behaves as a magnet.

Infact every current carrying coil is equivalent to a magnetic dipole (or magnet) of magnetic moment $m = IA = I \pi r^2$.

OR

Principle: When a charged particle is kept in a magnetic field it experiences a force and the perpendicular magnetic field causes the particle to spiral many times.

Working: The principle of action of the apparatus is shown in fig. The positive ions produced from a source S at the centre are accelerated by a dee which is at negative potential at that moment. Due to the presence of perpendicular magnetic field the ion will move in a circular path inside the dees. The magnetic field and the frequency of the applied voltages are so chosen that as the ion comes out of a dee, the dees change their polarity (positive becoming negative and vice-versa) and the ion is further accelerated and moves with higher velocity along a circular path of greater radius. The phenomenon is continued till the ion reaches at the periphery of the dees where an auxiliary negative electrode (deflecting plate) deflects the accelerated ion on the target to be bombarded.

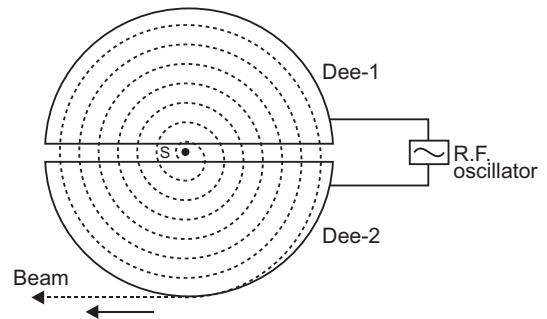
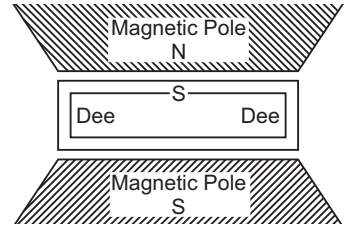

The **function of electric field** is to accelerate the charged particle and so to impart energy to the charged particle.

The function of magnetic field is to provide circular path to charged particle and so to provide the location where charged particle is capable of gaining energy from electric field.

Expression for Period of Revolution and Frequency:

Suppose the positive ion with charge q moves in a dee with a velocity v , then,

$$qvB = \frac{mv^2}{r} \text{ or } r = \frac{mv}{qB} \quad \dots(i)$$

where m is the mass and r the radius of the path of ion in the dee and B is the strength of the magnetic field.

The angular velocity of the ion is given by,

$$\frac{v}{r} = \frac{qB}{m} \text{ (from eq. i)} \quad \dots(ii)$$

The time taken by the ion in describing a semi-circle, *i.e.*, in turning through an angle π is,

$$t = \frac{m}{Bq} \quad \dots(iii)$$

Thus the time is independent of the speed of the ion *i.e.*, although the speed of the ion goes on increasing with increase in the radius (from eq. i) when it moves from one dee to the other, yet it takes the same time in each dee.

From eq. (iii) it is clear that for a particular ion, $\frac{m}{q}$ being known, B can be calculated for producing resonance with the high frequency alternating potential.

resonance with the high frequency alternating potential.

Resonance Condition: The condition of working of cyclotron is that the frequency of radio frequency alternating potential must be equal to the frequency of revolution of charged particles within the dees. This is called resonance condition.

Now for the cyclotron to work, the applied alternating potential should also have the same semi-periodic time ($T/2$) as that taken by the ion to cross either dee, i.e.,

$$\frac{T}{2} = t = \frac{m}{qB} \quad \dots(iv)$$

or
$$T = \frac{2m}{qB} \quad \dots(v)$$

This is the expression for period of revolution.

Obviously, period of revolution is independent of speed of charged particle and radius of circular path.

Frequency of revolution of particles

$$f = \frac{1}{T} = \frac{qB}{2m}$$

This frequency is called the **cyclotron frequency**. Clearly the cyclotron frequency is independent of speed of particle.

29. (a) Let PQR be the principal section of the prism. The refracting angle of the prism is A .

A ray of monochromatic light EF is incident on face PQ at angle of incidence i_1 . The refractive index of material of prism for this ray is n . This ray enters from rarer to denser medium and so is deviated towards the normal FN and gets refracted along the direction FG . The angle of refraction for this face is r_1 . The refracted ray FG becomes incident on face PR and is refracted away from the normal GN_2 and emerges in the direction GH . The angle of incidence on this face is r_2 (into prism) and angle of refraction (into air) is i_2 . The incident ray EF and emergent ray GH when produced meet at O . The angle between these two rays is called angle of deviation ' δ '.

$$\angle OFG = i_1 - r_1 \text{ and } \angle OGF = i_2 - r_2$$

In $\triangle FOG$, $\angle FOG$ is exterior angle

$$\angle FOG = \angle OFG + \angle OGF = (i_1 - r_1) + (i_2 - r_2) \quad \dots(i)$$

The normals FN_1 and GN_2 on faces PQ and PR respectively, when produced meet at N . Let $\angle FNG$

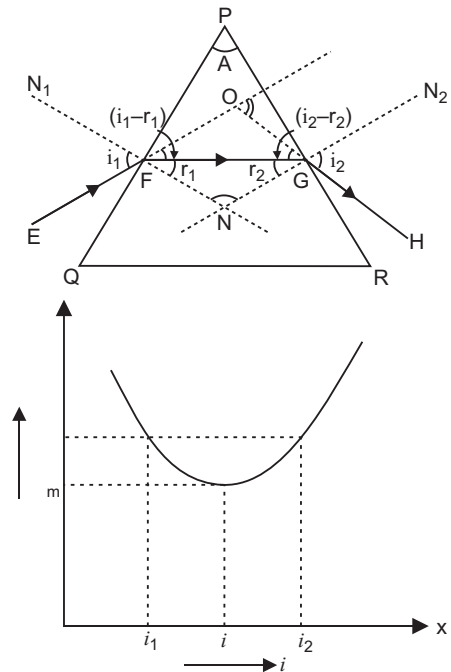

In FGN , $r_1 + r_2 = 180$...*(ii)*

In quadrilateral $PFNG$, $\angle PFN = 90^\circ$, $\angle PGN = 90^\circ$
 $\angle A = 90^\circ$ $\angle G = 90^\circ$ $\angle F = 360^\circ$ or $\angle A = 180^\circ$...*(iii)*

Comparing *(ii)* and *(iii)*, $r_1 + r_2 = A$...*(iv)*

Substituting this value in *(i)*, we get

$$i_1 + i_2 = A \quad \dots(v)$$

or $i_1 + i_2 = A$...*(vi)*

From Snell's law $n \frac{\sin i_1}{\sin r_1} = \frac{\sin i_2}{\sin r_2}$...*(vii)*

Minimum Deviation: From equation (v), it is clear that the angle of deviation depends upon the angle of incidence i_1 . As the path of light is reversible, therefore if angle of incidence be i_2 , then angle of emergence will be i_1 . Thus for two angles of incidence i_1 and i_2 , there will be one angle of deviation.

If we determine experimentally, the angles of deviation corresponding to different angles of incidence and then plot i (on X-axis) and d (on Y-axis), we get a curve as shown in figure. Clearly if angle of incidence is gradually increased, from a small value, the angle of deviation first decreases, becomes minimum for a particular angle of incidence and then begins to increase. Obviously for one angle of deviation (d_m), there are two angles of incidences i_1 and i_2 , but **for one and only one particular value of angle of incidence (i), the angle of deviation is the minimum.** This minimum angle of deviation is represented by d_m . For minimum deviation i_1 and i_2 become coincident, i.e., $i_1 = i_2 = i$ (say)

So from *(vii)* $n \frac{\sin i_1}{\sin r_1} = \frac{\sin i_2}{\sin r_2} = r$ (say)

Hence from *(iv)* and *(vi)*, we get

$$r + r = A \text{ or } r = A/2$$

and $i + i = A + d_m$ or $i = \frac{A + d_m}{2}$

Hence from Snell's law, $n \frac{\sin i}{\sin r} = \frac{\sin \frac{A + d_m}{2}}{\sin \frac{A}{2}}$

- (b) An optical fibre is a device based on total internal reflection by which a light signal may be transmitted from one place to another with a negligible loss of energy. When a light ray is incident on one end at a small angle of incidence, it suffers refraction from air to quartz and strikes the quartz-coating interface at an angle more than the critical angle and so suffers total internal reflection and strikes the opposite face again at an angle greater than critical angle and so again suffers total internal reflection. Thus the ray within the fibre suffers multiple total internal reflections and finally strikes the other end at an angle less than critical angle for quartz-air interface and emerges in air.

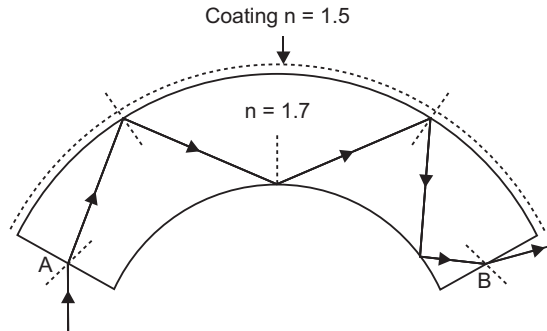

OR

(a) **Lens Maker's Formula:**

Suppose L is a thin lens. The refractive index of the material of lens is n_2 and it is placed in a medium of refractive index n_1 . The optical centre of lens is C and XX is principal axis. The radii of curvature of the

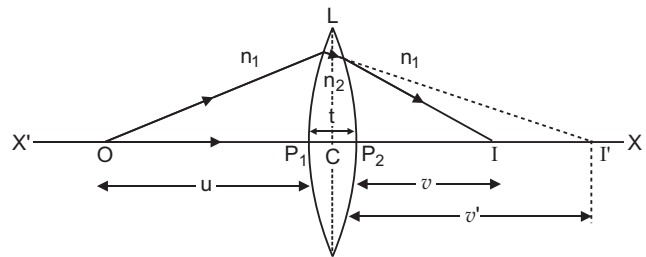

surfaces of the lens are R_1 and R_2 and their poles are P_1 and P_2 . The thickness of lens is t , which is very small. O is a point object on the principal axis of the lens. The distance of O from pole P_1 is u . The first refracting surface forms the image of O at I at a distance v from P_1 . From the refraction formula at spherical surface

$$\frac{n_2}{v} - \frac{n_1}{u} = \frac{n_2 - n_1}{R_1} \quad \dots(i)$$

The image I acts as a virtual object for second surface and after refraction at second surface, the final image is formed at I' . The distance of I from pole P_2 of second surface is v . The distance of virtual object (I) from pole P_2 is $(v - t)$.

For refraction at second surface, the ray is going from second medium (refractive index n_2) to first medium (refractive index n_1), therefore from refraction formula at spherical surface

$$\frac{n_1}{v'} - \frac{n_2}{(v - t)} = \frac{n_1 - n_2}{R_2} \quad \dots(ii)$$

For a thin lens t is negligible as compared to v , therefore from (ii)

$$\frac{n_1}{v'} - \frac{n_2}{v} = \frac{n_1 - n_2}{R_2} \quad \dots(iii)$$

Adding equations (i) and (iii), we get

$$\frac{n_1}{v'} - \frac{n_1}{u} = (n_2 - n_1) \left(\frac{1}{R_1} - \frac{1}{R_2} \right)$$

or
$$\frac{1}{v'} - \frac{1}{u} = \frac{n_2}{n_1} \left(\frac{1}{R_1} - \frac{1}{R_2} \right)$$

$$\text{i.e.} \quad \frac{1}{v} - \frac{1}{u} = (n_2 - n_1) \left(\frac{1}{R_1} - \frac{1}{R_2} \right) \quad \dots(iv)$$

where n_2 is refractive index of second medium (i.e. medium of lens) with respect to first medium.

If the object O is at infinity, the image will be formed at second focus i.e.

$$\text{if } u = \infty, \quad v = f_2 = f$$

Therefore from equation (iv)

$$\frac{1}{f} - \frac{1}{\infty} = (n_2 - n_1) \left(\frac{1}{R_1} - \frac{1}{R_2} \right)$$

$$\text{i.e.} \quad \frac{1}{f} = (n_2 - n_1) \left(\frac{1}{R_1} - \frac{1}{R_2} \right) \quad \dots(v)$$

This is the formula of refraction for a thin lens. This formula is called **Lens-Maker's formula**.

If first medium is air and refractive index of material of lens be n , then $n_2 = n$, therefore equation (v) may be written as

$$\frac{1}{f} = (n - 1) \left(\frac{1}{R_1} - \frac{1}{R_2} \right) \quad \dots(vi)$$

- (b) Ray Diagram: The ray diagram of image formation for an object between focus (F) and pole (P) of a concave mirror is shown in fig.

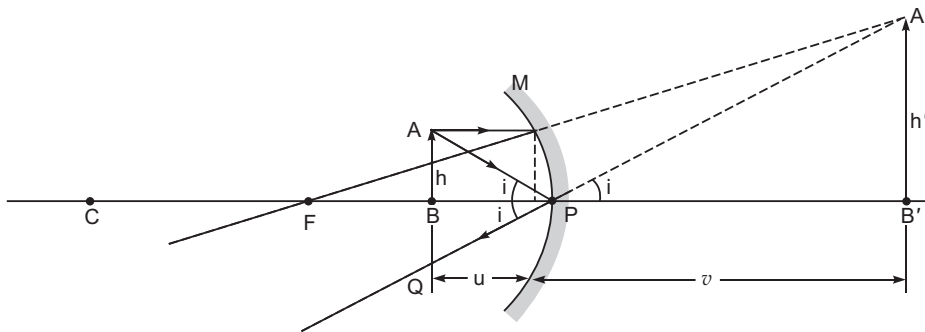

$$\text{Magnification: } m = \frac{\text{Size of image (A'B')}}{\text{Size of object (AB)}}$$

From fig. $\angle APB = \angle BPQ = i$

Also, $\angle BPQ = \angle A'PB' = i$

$$\text{In } \triangle APB, \tan i = \frac{AB}{BP} \quad \dots(1)$$

$$\text{In } \triangle A'PB', \tan i = \frac{A'B'}{B'P} \quad \dots(2)$$

From (1) and (2)

$$\frac{AB}{BP} = \frac{A B}{B P}$$

$$\text{Magnification, } m = \frac{A B}{AB} \frac{B P}{BP}$$

or
$$m = \frac{v}{-u} \text{ or } m = \frac{v}{u}$$

- 30. (i) Principle:** It is based on the principle of mutual inductance and transforms the alternating low voltage to alternating high voltage and in this the number of turns in secondary coil is more than that in primary coil. (i.e., $N_S > N_p$).

Working: When alternating current source is connected to the ends of primary coil, the current changes continuously in the primary coil; due to which the magnetic flux linked with the secondary coil changes continuously, therefore the alternating emf of same frequency is developed across the secondary.

Let N_p be the number of turns in primary coil, N_S the number of turns in secondary coil and the magnetic flux linked with each turn. **We assume that there is no leakage of flux so that the flux linked with each turn of primary coil and secondary coil is the same.** According to Faraday's laws the emf induced in the primary coil

$$e_p = -N_p \frac{d\phi}{dt} \quad \dots(i)$$

and emf induced in the secondary coil

$$e_S = -N_S \frac{d\phi}{dt} \quad \dots(ii)$$

From (i) and (ii)

$$\frac{e_S}{e_p} = \frac{N_S}{N_p} \quad \dots(iii)$$

If the resistance of primary coil is negligible, the emf (e_p) induced in the primary coil, will be equal to the applied potential difference (V_p) across its ends. Similarly if the secondary circuit is open, then the potential difference V_S across its ends will be equal to the emf (e_S) induced in it; therefore

$$\frac{V_S}{V_p} = \frac{e_S}{e_p} = \frac{N_S}{N_p} \quad r \text{ (say)} \quad \dots(iv)$$

where $r = \frac{N_S}{N_p}$ is called the *transformation ratio*. If i_p and i_S are the instantaneous currents in

primary and secondary coils and there is no loss of energy; then

For about 100% efficiency,

Power in primary = Power in secondary

$$\frac{V_p i_p}{i_p} = \frac{V_S i_S}{N_S} \frac{1}{r} \quad \dots(v)$$

In step up transformer, $N_s > N_p$; $r < 1$;

So $V_s > V_p$ and $i_s < i_p$

i.e., step up transformer increases the voltage.

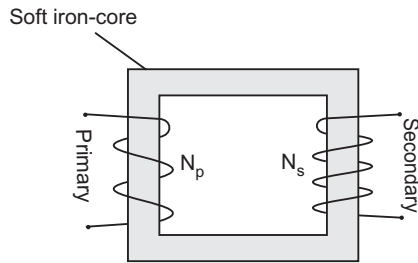

Two coils on separate limbs of the core

(ii) Reasons for energy losses in a transformer:

(a) **Joule Heating:** Energy is lost in resistance of primary and secondary windings as heat ($I^2 R t$).

(b) **Flux Leakage:** Energy is lost due to coupling of primary and secondary coils not being perfect, i.e., whole of magnetic flux generated in primary coil is not linked with the secondary coil.

(iii) When output voltage increases, the output current automatically decreases to keep the power same. Thus, there is no violation of conservation of energy in a step up transformer.

OR

(a) **Expression for Impedance in LCR series circuit:** Suppose resistance R , inductance L and capacitance C are connected in series and an alternating source of voltage $V = V_0 \sin \omega t$ is applied across it. (fig. a) On account of being in series, the current (i) flowing through all of them is the same.

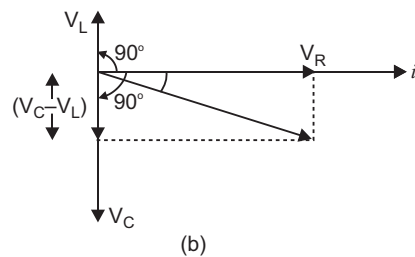
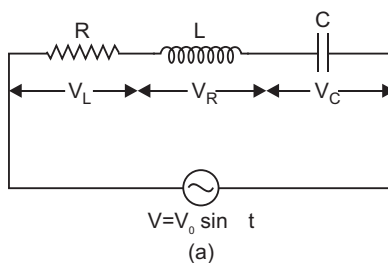

Suppose the voltage across resistance R is V_R , voltage across inductance L is V_L and voltage across capacitance C is V_C . The voltage V_R and current i are in the same phase, the voltage V_L will lead the current by angle 90° while the voltage V_C will lag behind the current by angle 90° (fig. b). Clearly V_C and V_L are in opposite directions, therefore their resultant potential difference $V_C - V_L$ (if $V_C > V_L$).

Thus V_R and $(V_C - V_L)$ are mutually perpendicular and the phase difference between them is 90° . As applied voltage across the circuit is V , the resultant of V_R and $(V_C - V_L)$ will also be V . From fig.

$$V^2 = V_R^2 + (V_C - V_L)^2 = V \sqrt{V_R^2 + (V_C - V_L)^2} \quad \dots(i)$$

But $V_R = Ri, V_C = X_C i$ and $V_L = X_L i$... (ii)

where $X_C = \frac{1}{C}$ capacitance reactance and $X_L = L$ inductive reactance

$$V = \sqrt{(Ri)^2 + (X_C i - X_L i)^2}$$

Impedance of circuit, $Z = \frac{V}{i} = \sqrt{R^2 + (X_C - X_L)^2}$

i.e. $Z = \sqrt{R^2 + \left(\frac{1}{C} - L\right)^2}$

Instantaneous current $I = \frac{V_0 \sin(\omega t)}{\sqrt{R^2 + \left(\frac{1}{C} - L\right)^2}}$

The phase difference (ϕ) between current and voltage is given by

$$\tan \phi = \frac{X_C - X_L}{R}$$

Resonant Frequency:

For resonance $\phi = 0$, so $X_C = X_L$ $\Rightarrow \frac{1}{C} = L$ $\Rightarrow \frac{1}{LC} = L^2$ $\Rightarrow \frac{1}{LC} = L^2$

Resonant frequency $f_r = \frac{1}{\sqrt{LC}}$

Graph of variation of current (i) with frequency (f):

The resonance in series LCR circuit occurs when inductive reactance is equal to capacitance reactance i.e., $X_L = X_C$. Alternatively when the frequency of applied a.c. source becomes

$$f_r = \frac{1}{2\sqrt{LC}}$$

Graph is shown in fig.

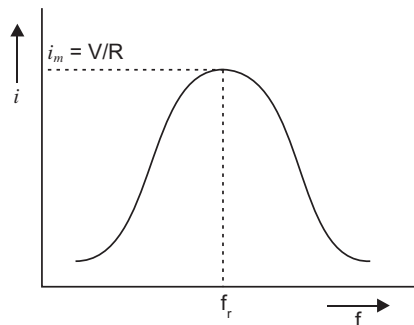

Use of phenomenon of resonance in tuning a radio or TV set:

A radio or a TV set has a L-C circuit with capacitor of variable capacitance C . The circuit remains connected with an aerial coil through the phenomenon of mutual inductance. Suppose a radio or TV station is transmitted a programme at frequency f , then waves produce alternating voltage of frequency f , in aerial, due to which an emf of same frequency is induced in LC circuit,

When capacitor C is in circuit is varied then for a particular value of capacitance C , $f = \frac{1}{2\sqrt{LC}}$,

the resonance occurs and maximum current flows in the circuit; so the radio or TV gets tuned.

CBSE (Delhi) SET-II

- 2. Susceptibility is small positive, so material is paramagnetic.
- 4. Electric field along Y-direction. Magnetic field along Z-direction.
(so that $\vec{K}, \vec{E}, \vec{B}$ form a right handed system)
- 10. According to Lenz’s law, the direction of induced current is such that it opposes the relative motion between coil and magnet.

The near face of coil C_1 will become S-pole, so the direction of current in coil C_1 will be **clockwise**.

The near face of coil C_2 will also become S-pole to oppose the approach of magnet, so the current in coil C_2 will also be **clockwise**.

- 11. Initial charge on C_1 and C_2 is

$$q_1 = q_2 = C_1 V = (2 \text{ F}) \times 5 \text{ V} = 10 \text{ C}$$

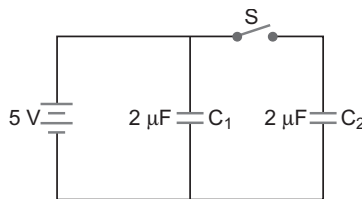

- (i) When switch S is opened the p.d. across C_1 remains 5V and charge on C_2 remains 10 C.

New capacitance of C_1 and C_2 after filling dielectric, $C_1 = C_2 = 5 \times 2 = 10 \text{ F}$.

Charge on C_1 , $q_1 = C_1 V_1 = (10 \text{ F}) \times 5 \text{ V} = 50 \text{ C}$

Charge on C_2 , $q_2 = q_2 = 10 \text{ C}$

- (ii) Potential difference across, $C_1 = V_1 = V_1 = 5 \text{ V}$

Potential difference across C_2 ,

$$V_2 = \frac{q_2}{C_2} = \frac{10 \text{ C}}{10 \text{ F}} = 1 \text{ V}$$

- 13. $Y = \overline{AB}$
 $X = \overline{\overline{AB} \overline{AB}} = \overline{\overline{AB} AB}$

That is the logic operation is AND operation. Therefore output is 1 only, when both inputs are 1. The output waveform is shown in figure.

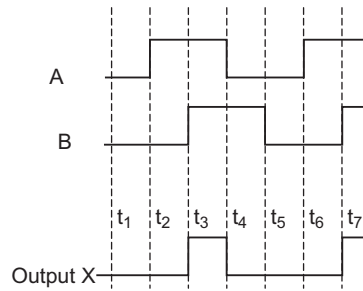

16. 1. Forward Bias:

- (i) Within the junction diode the direction of applied voltage is opposite to that of built-in potential.
- (ii) The current is due to diffusion of majority charge carriers through the junction and is of the order of milliamperes.
- (iii) The diode offers very small resistance in the forward bias.

2. Reverse Bias:

- (i) The direction of applied voltage and barrier potential is same.
- (ii) The current is due to leakage of minority charge carriers through the junction and is very small of the order of A.
- (iii) The diode offers very large resistance in reverse bias.

20. Effective resistance of R_2, R_3 and R_4 in parallel, is $\frac{1}{R} \frac{1}{R_2} \frac{1}{R_3} \frac{1}{R_4} \frac{1}{5} \frac{1}{5} \frac{1}{10} \frac{2}{10} \frac{2}{10} \frac{1}{10}$

$$R = 2$$

R_1 is in series with R , so equivalent resistance.

$$R_{eq} = R_1 + R = 4 + 2 = 6 \quad \dots(i)$$

$$\text{Current in } R_1, I_1 = \frac{E}{R_{eq}} = \frac{6}{6} = 1A \quad \dots(ii)$$

$$\text{Also, } I_2 = I_3 = I_4 = 1A \quad \dots(iii)$$

$$\text{and } I_2 R_2 = I_3 R_3 = I_4 R_4$$

$$\frac{5I_2}{I_2} = \frac{5I_3}{I_3} = \frac{10I_4}{2I_4} \quad \dots(iv)$$

Using equation (iv), equation (iii) gives

$$2I_4 = 2I_4 = I_4 = 1 \quad I_4 = \frac{1}{5} A = 0.2 A$$

$$I_2 = I_3 = 2 \times 0.2 = 0.4 A$$

$$I_1 = 1A, I_2 = 0.4A, I_3 = 0.4A, I_4 = 0.2 A \quad \dots(v)$$

23. Given $\lambda = 1.50 \text{ nm} = 1.50 \times 10^{-9} \text{ m}$.

(i) As momentum of electron = momentum of photon

$$= \frac{h}{\lambda} = \frac{6.63 \times 10^{-34}}{1.50 \times 10^{-9}} = 4.42 \times 10^{-25} \text{ kg m s}^{-1}$$

$$\begin{aligned}
 \text{(ii) Energy of photon, } E &= \frac{hc}{\lambda} \\
 &= 4.42 \times 10^{-25} \times 3 \times 10^8 \text{ J} \\
 &= 13.26 \times 10^{-17} \text{ J} \\
 &= \frac{13.26 \times 10^{-17}}{1.6 \times 10^{-19}} \text{ eV} = 828.7 \text{ eV}
 \end{aligned}$$

(iii) Kinetic energy of electron

$$\begin{aligned}
 E_K &= \frac{p^2}{2m_e} = \frac{(4.42 \times 10^{-25})^2}{2 \times 9.1 \times 10^{-31}} \text{ J} \\
 &= 1.07 \times 10^{-19} \text{ J} \\
 &= \frac{1.07 \times 10^{-19}}{1.6 \times 10^{-19}} \text{ eV} = 0.67 \text{ eV}
 \end{aligned}$$

24. The number of nuclei undergoing the decay per unit time, at any instant, is proportional to the total number of nuclei present in the sample at that instant. This is the law of radioactive decay.

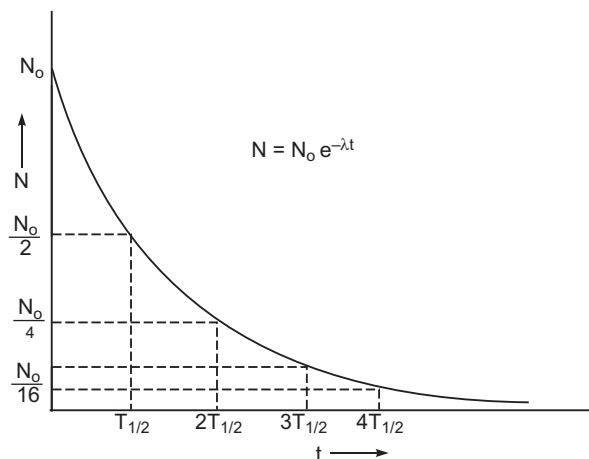

Number of undecayed nuclei at $t = 2T_{1/2}$ is $\frac{N_0}{4}$ and at $t = 4T_{1/2}$, it is $\frac{N_0}{16}$.

CBSE (Delhi) SET-III

2. Electric field along X -direction.
Magnetic field along Z -direction.
7. Susceptibility of material is negative, so given material is diamagnetic.
9. Formation of depletion layer:

At the junction there is diffusion of charge carriers due to thermal agitation; so that some of electrons of n -region diffuse to p -region while some of holes of p -region diffuse into n -region. Some charge carriers combine with opposite charges to neutralise each other. Thus near the junction there is an excess of positively charged ions in n -region and an excess of negatively

charged ions in p -region. This sets up a **potential difference** called potential barrier and hence an internal electric field E_i across the junctions. The field E_i is directed from n -region to p -region. This field stops the further diffusion of charge carriers. Thus the layers (10^{-4} cm to 10^{-6} cm) on either side of the junction becomes free from mobile charge carriers and hence is called the *depletion layer*.

14. (i) Charge on $C_1, q_1 = 6 \text{ C}$, Charge on $C_2, q_2 = 3 \text{ C}$
 (ii) P.D. across $C_1, V_1 = 2 \text{ V}$, P.D. across $C_2, V_2 = \frac{q_2}{C_2} = \frac{3 \text{ C}}{3 \text{ F}} = 1 \text{ V}$

16. $C = \overline{A}, D = \overline{B}$
 $Y = \overline{CD} = \overline{\overline{A} \overline{B}} = \overline{\overline{A} \overline{B}} = A B$

The logic circuit performs OR-operation.

Truth table.

A	B	Y
0	0	0
1	0	1
0	1	1
1	1	1

17. Current induced in coil will oppose the approach of magnet; therefore, left face of coil will act as N -pole and right face as S -pole. For this the current in coil will be anticlockwise as seen from left, therefore, the plate A of capacitor will be positive and plate B will be negative.

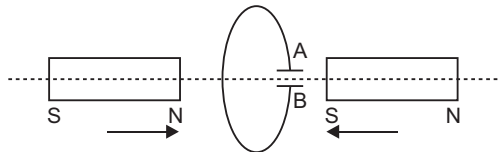

23. $R_1 = 2 \Omega, R_2 = R_3 = 10 \Omega, R_4 = 20 \Omega, E = 6 \text{ V}$

Equivalent Resistance: R_2, R_3 and R_4 are in parallel, their effective resistance R is

$$\frac{1}{R} = \frac{1}{R_2} + \frac{1}{R_3} + \frac{1}{R_4} = \frac{1}{10} + \frac{1}{10} + \frac{1}{20} = \frac{2}{20} + \frac{2}{20} + \frac{1}{20}$$

$$R = \frac{20}{5} = 4 \Omega$$

$$R_{eq} = R_1 + R = 2 + 4 = 6 \Omega$$

Current in $R_1, I_1 = \frac{E}{R_{eq}} = \frac{6}{6} = 1 \text{ A}$

Also, $I_2 R_2 = I_3 R_3 = I_4 R_4$

$$I_2 \cdot 10 = I_3 \cdot 10 = I_4 \cdot 20$$

$$I_2 = I_3 = 2I_4 \quad \dots(i)$$

and $I_2 + I_3 + I_4 = 1 \text{ A} \quad \dots(ii)$

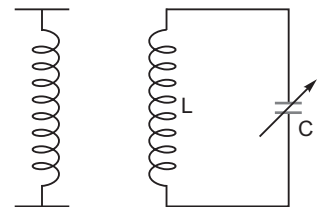

Solving (i) and (ii)

$$I_2 = I_3 = 0.4 \text{ A}, \quad I_4 = 0.2 \text{ A}$$

25. $= 2 \text{ nm} = 2 \times 10^{-9} \text{ m}$

(i) Momentum of electron = Momentum of photon p

$$= \frac{h}{\lambda} = \frac{6.63 \times 10^{-34}}{2 \times 10^{-9}} = 3.315 \times 10^{-25} \text{ kg m s}^{-1}$$

(ii) Energy of photon, $E = pc$

$$= 3.315 \times 10^{-25} \times 3 \times 10^8 \text{ J}$$

$$= 9.945 \times 10^{-17} \text{ J} = \frac{9.945 \times 10^{-17}}{1.6 \times 10^{-19}} \text{ eV}$$

$$= 6.216 \times 10^2 \text{ eV} = 0.62 \text{ keV}$$

(iii) Kinetic energy of electrons

$$E_K = \frac{1}{2} m_e v^2 = \frac{p^2}{2m_e} = \frac{(3.315 \times 10^{-25})^2}{2 \times 9.1 \times 10^{-31}} \text{ J}$$

$$= 0.604 \times 10^{-19} \text{ J} = 0.38 \text{ eV}$$

CBSE EXAMINATION PAPERS

ALL INDIA-2011

Time allowed: 3 hours

Maximum marks: 70

General Instructions:

- All questions are compulsory.
- There are 30 questions in total. Questions 1 to 8 carry one mark each, questions 9 to 18 carry two marks each, questions 19 to 27 carry three marks each and questions 28 to 30 carry five marks each.
- There is no overall choice. However, an internal choice has been provided in one question of two marks, one question of three marks and all three questions of five marks each. You have to attempt only one of the given choices in such questions.
- Use of calculators is not permitted.
- You may use the following values of physical constants wherever necessary:

$$c = 3 \times 10^8 \text{ ms}^{-1}$$

$$h = 6.626 \times 10^{-34} \text{ Js}$$

$$e = 1.602 \times 10^{-19} \text{ C}$$

$$\mu_0 = 4\pi \times 10^{-7} \text{ TmA}^{-1}$$

$$\frac{1}{4\pi\epsilon_0} = 9 \times 10^9 \text{ Nm}^2\text{C}^{-2}$$

$$\text{Boltzmann's constant } k = 1.381 \times 10^{-23} \text{ JK}^{-1}$$

$$\text{Avogadro's number } N_A = 6.022 \times 10^{23} / \text{mole}$$

$$\text{Mass of neutron } m_n = 1.675 \times 10^{-27} \text{ kg}$$

$$\text{Mass of electron } m_e = 9.1 \times 10^{-31} \text{ kg}$$

$$\text{Radius of earth} = 6400 \text{ km}$$

CBSE (All India) SET-I

- Define electric dipole moment. Write its S.I. unit.
- Where on the surface of Earth is the angle of dip 90° ?
- A hollow metal sphere of radius 5 cm is charged such that the potential on its surface is 10 V. What is the potential at the centre of the sphere?
- How are radio waves produced?
- Write any two characteristic properties of nuclear force.
- Two bar magnets are quickly moved towards a metallic loop connected across a capacitor 'C' as shown in the figure. Predict the polarity of the capacitor.

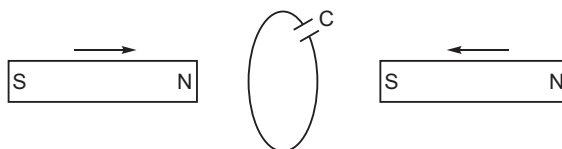

7. What happens to the width of depletion layer of a p - n junction when it is (i) forward biased, (ii) reverse biased?
8. Define the term 'stopping potential' in relation to photoelectric effect.
9. A thin straight infinitely long conducting wire having charge density λ is enclosed by a cylindrical surface of radius r and length l , its axis coinciding with the length of the wire. Find the expression for the electric flux through the surface of the cylinder.
10. Plot a graph showing the variation of coulomb force (F) versus $\frac{1}{r^2}$, where r is the distance between the two charges of each pair of charges: (1 C, 2 C) and (2 C – 3 C). Interpret the graphs obtained.
11. Write the expression for Lorentz magnetic force on a particle of charge ' q ' moving with velocity v in a magnetic field B . Show that no work is done by this force on the charged particle.

OR

A steady current (I_1) flows through a long straight wire. Another wire carrying steady current (I_2) in the same direction is kept close and parallel to the first wire. Show with the help of a diagram how the magnetic field due to the current I_1 exerts a magnetic force on the second wire. Write the expression for this force.

12. What are eddy currents? Write any two applications of eddy currents.
13. What is sky wave communication? Why is this mode of propagation restricted to the frequencies only up to few MHz?
14. In the given circuit, assuming point A to be at zero potential, use Kirchoff's rules to determine the potential at point B.

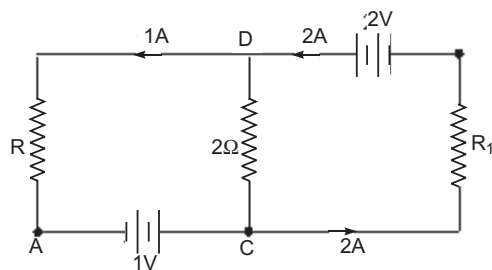

15. A parallel plate capacitor is being charged by a time varying current. Explain briefly how Ampere's circuital law is generalized to incorporate the effect due to the displacement current.
16. Net capacitance of three identical capacitors in series is 1 F. What will be their net capacitance if connected in parallel?
Find the ratio of energy stored in the two configurations if they are both connected to the same source.
17. Using the curve for the binding energy per nucleon as a function of mass number A , state clearly how the release in energy in the processes of nuclear fission and nuclear fusion can be explained.
18. In the meter bridge experiment, balance point was observed at J with $AJ = l$.

- (i) The values of R and X were doubled and then interchanged. What would be the new position of balance point?
- (ii) If the galvanometer and battery are interchanged at the balance position, how will the balance point get affected?

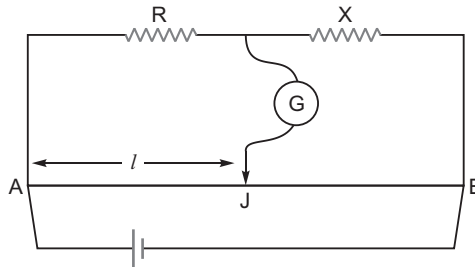

19. A convex lens made up of glass of refractive index 1.5 is dipped, in turn, in (i) a medium of refractive index 1.65, (ii) a medium of refractive index 1.33.
- (a) Will it behave as a converging or a diverging lens in the two cases?
- (b) How will its focal length change in the two media?
20. Draw a plot showing the variation of photoelectric current with collector plate potential for two different frequencies, ν_1 ν_2 , of incident radiation having the same intensity. In which case will the stopping potential be higher? Justify your answer.
21. Write briefly any two factors which demonstrate the need for modulating a signal. Draw a suitable diagram to show amplitude modulation using a sinusoidal signal as the modulating signal.
22. Use the mirror equation to show that
- (a) an object placed between f and $2f$ of a concave mirror produces a real image beyond $2f$.
- (b) a convex mirror always produces a virtual image independent of the location of the object.
- (c) an object placed between the pole and focus of a concave mirror produces a virtual and enlarged image.
23. Draw a labelled diagram of a full wave rectifier circuit. State its working principle. Show the input-output waveforms.
24. (a) Using de Broglie's hypothesis, explain with the help of a suitable diagram, Bohr's second postulate of quantization of energy levels in a hydrogen atom.
- (b) The ground state energy of hydrogen atom is -13.6 eV. What are the kinetic and potential energies of the electron in this state?
25. You are given a circuit below. Write its truth table. Hence, identify the logic operation carried out by this circuit. Draw the logic symbol of the gate it corresponds to.

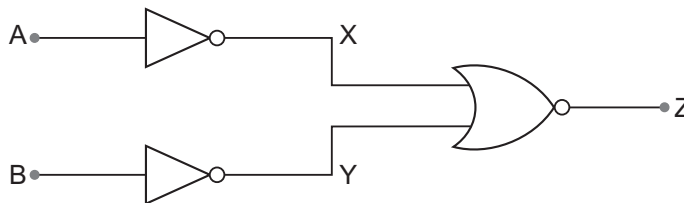

26. A compound microscope uses an objective lens of focal length 4 cm and eyepiece lens of focal length 10 cm. An object is placed at 6 cm from the objective lens. Calculate the magnifying power of the compound microscope. Also calculate the length of the microscope.

OR

A giant refracting telescope at an observatory has an objective lens of focal length 15 m. If an eyepiece lens of focal length 1.0 cm is used, find the angular magnification of the telescope.

If this telescope is used to view the moon, what is the diameter of the image of the moon formed by the objective lens? The diameter of the moon is 3.42×10^6 m and the radius of the lunar orbit is 3.8×10^8 m.

27. Two heating elements of resistance R_1 and R_2 when operated at a constant supply of voltage, V , consume powers P_1 and P_2 respectively. Deduce the expressions for the power of their combination when they are, in turn, connected in (i) series and (ii) parallel across the same voltage supply.
28. (a) State the principle of the working of a moving coil galvanometer, giving its labelled diagram.
 (b) "Increasing the current sensitivity of a galvanometer may not necessarily increase its voltage sensitivity." Justify this statement.
 (c) Outline the necessary steps to convert a galvanometer of resistance R_G into an ammeter of a given range.

OR

- (a) Using Ampere's circuital law, obtain the expression for the magnetic field due to a long solenoid at a point inside the solenoid on its axis.
 (b) In what respect is a toroid different from a solenoid? Draw and compare the pattern of the magnetic field lines in the two cases.
 (c) How is the magnetic field inside a given solenoid made strong?
29. State the working of a.c. generator with the help of a labelled diagram. The coil of an a.c. generator having N turns, each of area A , is rotated with a constant angular velocity ω . Deduce the expression for the alternating e.m.f. generated in the coil. What is the source of energy generation in this device?

OR

- (a) Show that in an a.c. circuit containing a pure inductor, the voltage is ahead of current by $\pi/2$ in phase.
 (b) A horizontal straight wire of length L extending from east to west is falling with speed v at right angles to the horizontal component of Earth's magnetic field B .
 (i) Write the expression for the instantaneous value of the e.m.f. induced in the wire.
 (ii) What is the direction of the e.m.f.?
 (iii) Which end of the wire is at the higher potential?
30. State the importance of coherent sources in the phenomenon of interference. In Young's double slit experiment to produce interference pattern, obtain the conditions for constructive and destructive interference. Hence, deduce the expression for the fringe width. How does the fringe width get affected, if the entire experimental apparatus of Young is immersed in water?

OR

- (a) State Huygen’s principle. Using this principle explain how a diffraction pattern is obtained on a screen due to a narrow slit on which a narrow beam coming from a monochromatic source of light is incident normally.
- (b) Show that the angular width of the first diffraction fringe is half of that of the central fringe.
- (c) If a monochromatic source of light is replaced by white light, what change would you observe in the diffraction pattern?

CBSE (All India) SET-II

Questions uncommon to Set-I

- 1. A hollow metal sphere of radius 10 cm is charged such that the potential on its surface is 5V. What is the potential at the centre of the sphere?
- 2. How are X-rays produced?
- 4. Where on the surface of Earth is the angle of dip zero?
- 9. Net capacitance of three identical capacitors in series is 2 F. What will be their net capacitance if connected in parallel?
Find the ratio of energy stored in the two configurations if they are both connected to the same source.
- 12. State the principle of working of a transformer. Can a transformer be used to step up or step down a d.c. voltage? Justify your answer.
- 14. In the given circuit, assuming point A to be at zero potential, use Kirchoff’s rules to determine the potential at point B.

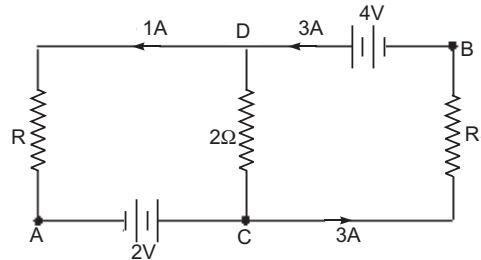

- 17. What is ground wave communication? On what factors does the maximum range of propagation in this mode depend?
- 21. You are given a circuit below. Write its truth table. Hence, identify the logic operation carried out by this circuit. Draw the logic symbol of the gate it corresponds to.

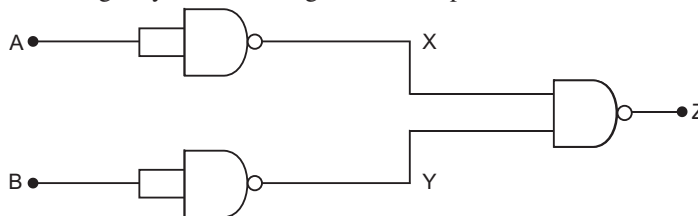

CBSE (All India) SET-III*Questions uncommon to Set – I & II*

1. A hollow metal sphere of radius 6 cm is charged such that the potential on its surface is 12 V. What is the potential at the centre of the sphere?
3. How are microwaves produced?
7. Where on the surface of Earth is the vertical component of Earth's magnetic field zero?
12. Mention various energy losses in a transformer.
14. In the given circuit, assuming point A to be at zero potential, use Kirchoff's rules to determine the potential at point B.

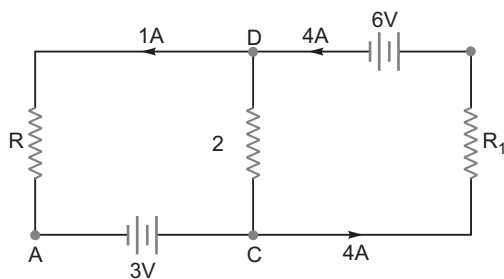

16. What is space wave communication? Write the range of frequencies suitable for space wave communication.
20. A converging lens has a focal length of 20 cm in air. It is made of a material of refractive index 1.6. It is immersed in a liquid of refractive index 1.3. Calculate its new focal length.
22. You are given a circuit below. Write its truth table. Hence, identify the logic operation carried out by this circuit. Draw the logic symbol of the gate it corresponds to.

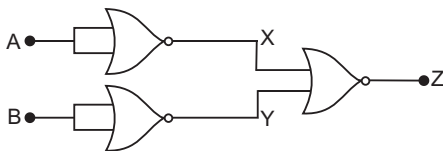

Solutions

CBSE (All India) SET-I

- Electric dipole moment is defined as the numerical product of either charge and the distance between the charges, and is directed from negative to positive charge.
The SI unit of electric dipole moment is coulomb metre (Cm).
- Angle of dip is 90° at the poles.
- Potential at centre of sphere = 10 V.
- Radio waves are produced by the accelerated motion of charges in conducting wires.
- Nuclear forces are short range attractive forces.
 - Nuclear forces are charge - independent.
- Current induced in coil will oppose the approach of magnet; therefore, left face of coil will act as *N*-pole and right face as *S*-pole. For this the current in coil will be anticlockwise as seen from left, therefore, the plate *A* of capacitor will be positive and plate *B* will be negative. The upper plate is positive and lower plate is negative.

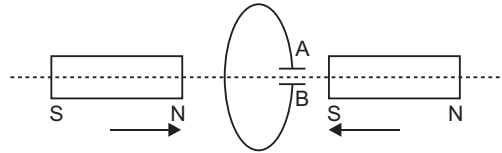

- When forward biased, the width of depletion layer decreases.
 - When reverse biased, the width of depletion layer increases.
- The minimum retarding (negative) potential of anode of a photoelectric tube for which photoelectric current stops or becomes zero is called the stopping potential.
- Charge enclosed by the cylindrical surface l

By Gauss Theorem, electric flux = $\frac{1}{\epsilon_0} \times$ charge enclosed.

$$= \frac{1}{\epsilon_0} (l)$$

10. $F = \frac{1}{4\pi\epsilon_0} \frac{q_1 q_2}{r^2}$.

The graph between F and $\frac{1}{r^2}$ is a straight line of slope $\frac{1}{4\pi\epsilon_0} q_1 q_2$ passing through origin.

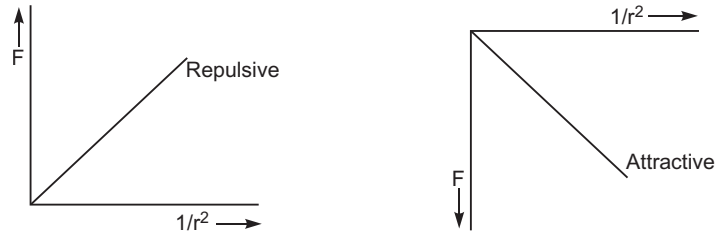

Since, magnitude of the slope is more for attraction, therefore, attractive force is greater than repulsive force.

11. Lorentz magnetic force, $\vec{F}_m = q \vec{v} \times \vec{B}$

Work done, $W = \int \vec{F}_m \cdot d\vec{s} = \int q(\vec{v} \times \vec{B}) \cdot d\vec{s}$

As $(\vec{v} \times \vec{B}) \cdot d\vec{s} = 0$

Work, $W = 0$

OR

Suppose two long thin straight conductors (or wires) PQ and RS are placed parallel to each other in vacuum (or air) carrying currents I_1 and I_2 respectively. It has been observed experimentally that when the currents in the wire are in the same direction, they experience an attractive force and when they carry currents in opposite directions, they experience a repulsive force.

Let the conductors PQ and RS carry currents I_1 and I_2 in same direction

and placed at separation r . Consider a current-element 'ab' of length L of wire RS . The magnetic field produced by current-carrying conductor PQ at the location of other wire RS

$$B_1 = \frac{\mu_0 I_1}{2r}$$

$$F = B_1 I_2 L \sin 90^\circ = \frac{\mu_0 I_1 I_2}{2r} L$$

The total force on conductor of length L will be

$$F = \frac{\mu_0 I_1 I_2}{2r} L$$

Force acting on per unit length of conductor

$$f = \frac{F}{L} = \frac{\mu_0 I_1 I_2}{2r} \text{ N/m}$$

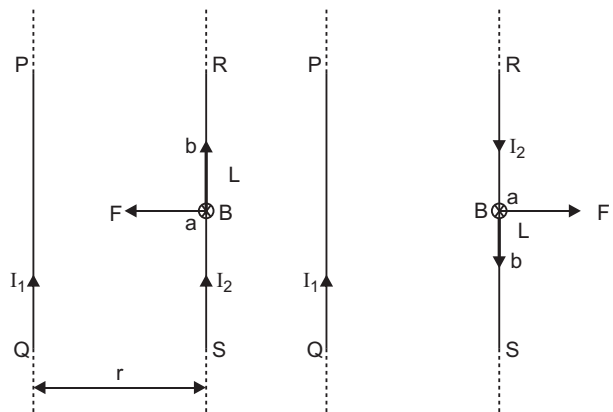

- 12. Eddy currents:** When a metallic plate is placed in a time varying magnetic field, the magnetic flux linked with the plate changes, the induced currents are set up in the plate; these currents are called **eddy currents**. These currents are sometimes so strong, that the metallic plate becomes red hot. In transformer frames there is a huge loss of energy due to production of eddy currents, so these currents are undesirable in transformer.

Application of Eddy Currents:

- 1. Induction Furnace:** In induction furnace, the metal to be heated is placed in a rapidly varying magnetic field produced by high frequency alternating current. Strong eddy currents are set up in the metal produce so much heat that the metal melts. This process is used in extracting a metal from its ore. The arrangement of heating the metal by means of strong induced currents is called the induction furnace.
- 2. Induction Motor:** The eddy currents may be used to rotate the rotor. Its principle is: When a metallic cylinder (or rotor) is placed in a rotating magnetic field, eddy currents are produced in it. According to Lenz's law, these currents tend to reduce to relative motion between the cylinder and the field. The cylinder, therefore, begins to rotate in the direction of the field. This is the principle of induction motion.

- 13.** Sky wave propagation is a mode of propagation in which communication of radiowaves in frequency range 30 MHz–40 MHz takes place due to reflection from the ionosphere. For frequencies higher than few MHz, the sky waves penetrate the ionosphere and are not reflected back.

- 14.** Current in $2\ \Omega$ resistor is 1 A. Applying Kirchoff's II law along the path ACDB,
 $V_A + 1 + 2 \times 1 - 2 = V_B$.
 As $V_A = 0$
 $V_B = 1 + 2 - 2 = 1\ \text{V}$.

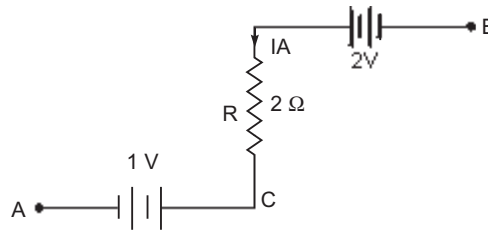

- 15.** Displacement current and generalised Ampere's Circuital Law: Consider a parallel plate capacitor, being charged by a battery. A time varying current is flowing through the capacitor. If we consider only the conduction current I , then we apply Ampere's Circuital Law to two closed loops C_1 and C_2 , then we get

$$\oint_{C_1} \mathbf{B} \cdot d\mathbf{l} = \mu_0 I \quad \dots(i)$$

and $\oint_{C_2} \mathbf{B} \cdot d\mathbf{l} = 0 \quad \dots(ii)$

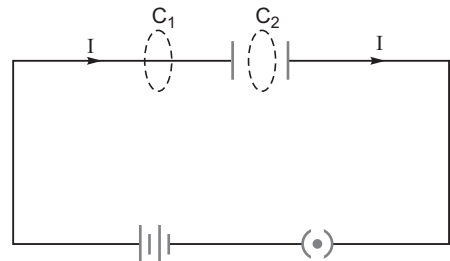

Since there cannot be any conduction current in region between the capacitor plates. As C_1 and C_2 are very close, we must expect

$$\oint_{C_1} B \, dl = \oint_{C_2} B \, dl \quad \dots(iii)$$

But this condition is violated by equations (i) and (ii). Hence Ampere's Circuital Law seems to be inconsistent in this case. Therefore, Maxwell postulated the existence of displacement current which is produced by time varying electric field. If $\sigma(t)$ is the surface charge density on capacitor plates and $q(t)$ is the charge, then time varying electric field $E(t) = \frac{\sigma(t)}{\epsilon_0} = \frac{q(t)}{A \epsilon_0}$, where A is area of each plate.

$$\frac{dE}{dt} = \frac{1}{A \epsilon_0} \frac{dq(t)}{dt}$$

or
$$\frac{dq(t)}{dt} = \epsilon_0 A \frac{dE}{dt}$$

This is expression for displacement current (I_d).

Applying Kirchoff's first law at power P, we get $I = I_d$

Hence, equation (i) and (ii) take the forms

$$\oint_{C_1} B \, dl = \mu_0 I \quad \text{and} \quad \oint_{C_2} B \, dl = \mu_0 (I + I_d)$$

The total current is the sum of the conduction current and displacement current. Thus, modified form of Ampere's circuital law is

$$\oint B \cdot dl = \mu_0 (I + I_d) = \mu_0 I + \mu_0 \epsilon_0 A \frac{dE}{dt}$$

But $EA = \text{Electric flux } \Phi_E$

$$\oint B \cdot dl = \mu_0 (I + \epsilon_0 \frac{d\Phi_E}{dt})$$

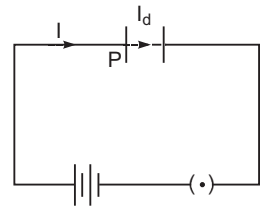

16. Let C be the capacitance of each capacitor, then in series

$$\frac{1}{C_s} = \frac{1}{C} + \frac{1}{C} + \frac{1}{C} = \frac{3}{C}$$

or $C = \frac{3C}{3} = C = 3 \times 1 \text{ F} = 3 \text{ F}$

When these capacitors are connected in parallel, net capacitance, $C_p = 3C = 3 \times 3 = 9 \text{ F}$

When these two combinations are connected to same source the potential difference across each combination is same.

Ratio of energy stored,

$$\frac{U_s}{U_p} = \frac{\frac{1}{2} C_s V^2}{\frac{1}{2} C_p V^2} = \frac{C_s}{C_p} = \frac{3 \text{ F}}{9 \text{ F}} = \frac{1}{3}$$

$$U_s : U_p = 1 : 3$$

17. The variation of binding energy per nucleon versus mass number is shown in figure.

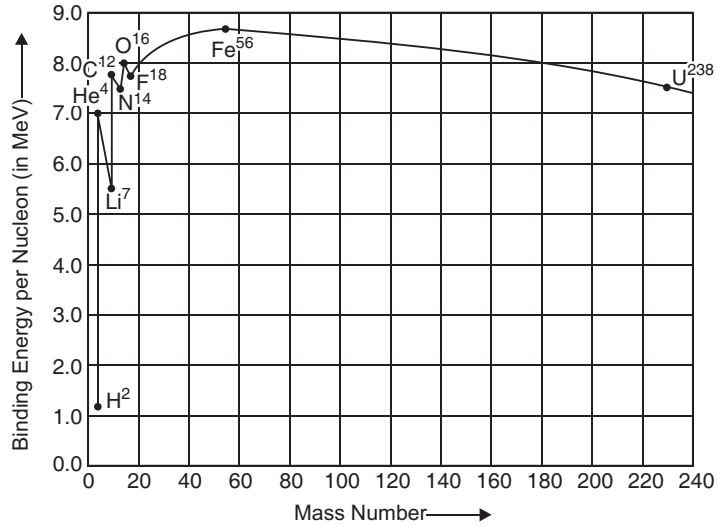

Explanation: When a heavy nucleus ($A = 235$ say) breaks into two lighter nuclei (nuclear fission), the binding energy per nucleon increases *i.e.*, nucleons get more tightly bound. This implies that energy would be released in nuclear fission.

When two very light nuclei ($A = 10$) join to form a heavy nucleus, the binding energy per nucleon of fused heavier nucleus is more than the binding energy per nucleon of lighter nuclei, so again energy would be released in nuclear **fusion**.

18. (i)
$$\frac{R}{X} = \frac{rl}{r(100 - l)}$$

$$\frac{R}{X} = \frac{l}{100 - l} \quad \dots(i)$$

When both R and X are doubled and then interchanged, the new balance length becomes l given by

$$\frac{2X}{2R} = \frac{l}{(100 - l)}$$

$$\frac{X}{R} = \frac{l}{100 - l} \quad \dots(ii)$$

From (i) and (ii),

$$\frac{100 - l}{l} = \frac{l}{100 - l}$$

$$l = (100 - l)$$

- (ii) If galvanometer and battery are interchanged, there is no effect on the balance point.

19. Focal length of lens in liquid (l)

$$f_l = \frac{a n_g - 1}{l n_g - 1} f_a = \frac{n_g - 1}{\frac{n_g}{n_l} - 1} f_a$$

(a) (i) $n_g = 1.5, n_l = 1.65$

$\frac{n_g}{n_l} = \frac{1.5}{1.65} < 1$, so f_l and f_a are of opposite sign, so convex lens in liquid $n_l = 1.65$ behaves as

a diverging lens

(ii) $n_g = 1.5, n_l = 1.33$

$$\frac{n_g}{n_l} = \frac{1.5}{1.33} > 1$$

so f_l and f_a are of same sign, so convex lens in liquid ($n_l = 1.33$) behaves as a convergent lens

(b) (i) Focal length, $f_l = \frac{1.5 - 1}{\frac{1.5}{1.65} - 1} f_a = 5.5 f_a$ (Focal length becomes negative and its magnitude increases)

(ii) Focal length, $f_l = \frac{1.5 - 1}{\frac{1.5}{1.33} - 1} f_a = 4 f_a$ (Focal length increases)

20. The plots are shown in fig. The stopping potential (V_s) is higher for radiations of frequency ν_1 . Stopping potential is directly proportional to the frequency of incident radiation.

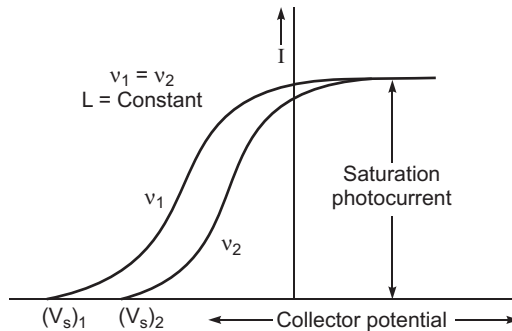

21. The modulation is needed due to

- (i) Transmission of audio frequency electrical signals need long impracticable antenna.
- (ii) The power radiated at audio frequency is quite small, hence transmission is quite lossy.
- (iii) The various information signals transmitted at low frequency get mixed and hence can not be distinguished.

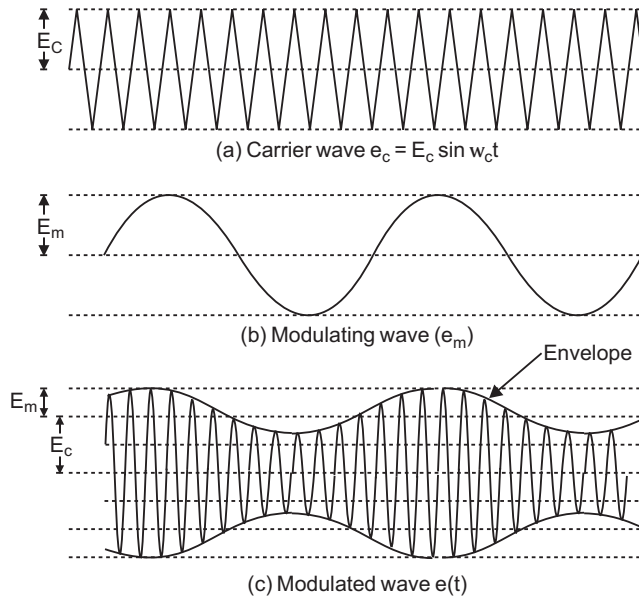

22. Mirror equation is $\frac{1}{f} = \frac{1}{v} + \frac{1}{u}$ or $\frac{1}{v} = \frac{1}{f} - \frac{1}{u}$

(a) For a concave mirror, f is negative, *i.e.*, $f < 0$.

For a real object (on the left of mirror).

For u between f and $2f$ implies $\frac{1}{u}$ lies between $\frac{1}{f}$ and $\frac{1}{2f}$ *i.e.*, $\frac{1}{2f} < \frac{1}{u} < \frac{1}{f}$ (as u, f are negative)

$$\text{or } \frac{1}{2f} < \frac{1}{u} < \frac{1}{f}$$

$$\text{or } \frac{1}{f} - \frac{1}{2f} < \frac{1}{f} - \frac{1}{u} < 0$$

$$\text{or } \frac{1}{2f} < \frac{1}{v} < 0$$

i.e., $\frac{1}{v}$ is negative.

This implies that v is negative and greater than $2f$. This means that the image lies beyond $2f$ and it is real.

(b) For a convex mirror, f is positive *i.e.*, $f > 0$.

For a real object on the left u is negative.

$$\frac{1}{f} = \frac{1}{v} + \frac{1}{u} \text{ implies } \frac{1}{v} = \frac{1}{f} - \frac{1}{u}$$

As u is negative and f is positive; $\frac{1}{v}$ must be positive, so v must be positive *i.e.*, image lies behind the mirror. Hence, image is virtual whatever the value of u may be.

(c) For a mirror,

$$\frac{1}{v} + \frac{1}{f} = \frac{1}{u} \quad \dots(i)$$

For a concave mirror, f is negative $f < 0$

As u is also negative, so $f + u < 0$

This implies, $\frac{1}{f} + \frac{1}{u} < 0$

Then from (1) $\frac{1}{v} > 0$ or v is positive.

i.e., image is on the right and hence **virtual**.

Magnification, $m = \frac{v}{u} = \frac{f}{u - f}$

As u is negative and f is positive, magnification $m = \frac{|f|}{|f| - |u|} > 1$

i.e., image is **enlarged**.

23. Full Wave Rectifier

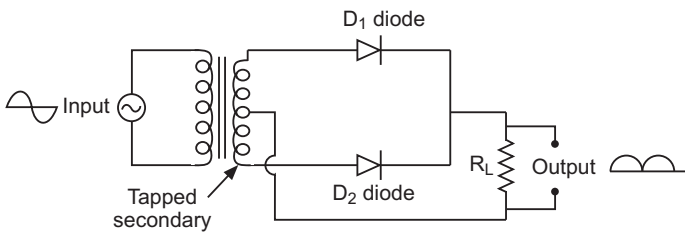

Principle: It works on the principle that p - n junction conducts when it is in forward bias and does not do so when it is in reverse bias.

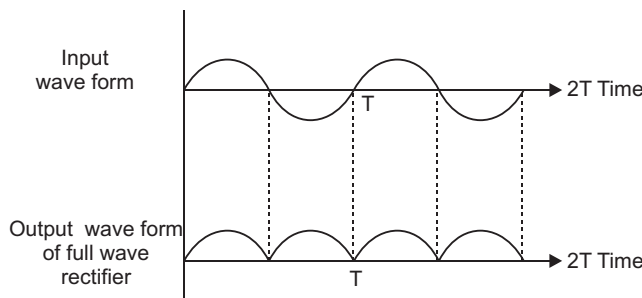

24. (a) According to de Broglie's hypothesis,

$$\lambda = \frac{h}{mv} \quad \dots(i)$$

According to de Broglie's condition of stationary orbits, the stationary orbits are those which contain complete de-Broglie wavelength.

$$2\pi r = n\lambda \quad \dots(ii)$$

Substituting value of r from (ii) in (i), we get

$$2 r = n \frac{h}{m v}$$

$$m v r = n \frac{h}{2} \quad \dots(iii)$$

This is Bohr's postulate of quantisation of energy levels.

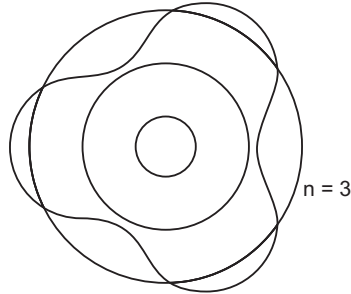

(b) Kinetic energy, $K = \frac{1}{2} m v^2 = \frac{1}{4} \frac{e^2}{2r}$...(i)

Potential energy, $U = \frac{1}{4} \frac{e^2}{r}$...(ii)

Total energy $E = K + U = \frac{1}{4} \frac{e^2}{2r}$...(iii)

Comparing equations (i), (ii), (iii), we have

$$K = E \text{ and } U = 2E$$

Given $E = 13.6 \text{ eV}$ (in ground state)

Kinetic energy, $K = 13.6 \text{ eV}$

Potential energy $U = 2 (13.6 \text{ eV}) = 27.2 \text{ eV}$

25. The output $Y = \overline{\overline{A} \overline{B}} = \overline{\overline{A} \overline{B}} = AB$

That is equivalent gate is 'AND' gate.

The logic symbol and truth table are shown:



Truth Table

A	B	Y
0	0	0
1	0	0
0	1	0
1	1	1

26. Given $f_o = 4 \text{ cm}$, $f_e = 10 \text{ cm}$

$$u_o = -6 \text{ cm}$$

Magnifying power of microscope

$$M = \frac{v_o}{u_o} \times \frac{D}{f_e}$$

$$\begin{aligned} \text{From lens formula } \frac{1}{f_o} &= \frac{1}{v_o} - \frac{1}{u_o} \\ &= \frac{1}{v_o} - \frac{1}{-6} = \frac{1}{v_o} + \frac{1}{6} \end{aligned}$$

$$v_o = 12 \text{ cm}$$

$$m = -\frac{v_o}{u_o} = -\frac{12}{-6} = 2$$

Negative sign shows that the image is inverted.

$$\text{Length of microscope } L = |v_o| + |u_e|$$

$$\begin{aligned} \text{For eye lens } \frac{1}{f_e} &= \frac{1}{v_e} - \frac{1}{u_e} \\ &= \frac{1}{u_e} - \frac{1}{v_e} \end{aligned} \quad (v_e = D = 25 \text{ cm}, u_e = ?)$$

$$u_e = \frac{50}{7} \text{ (cm)} \approx 7.14$$

$$L = |v_o| + |u_e| = 12 + 7.14 = 19.14 \text{ cm}$$

OR

Given $f_o = 15 \text{ m}$, $f_e = 10 \text{ cm} = 0.10 \text{ m}$

Angular magnification of telescope,

$$m = \frac{f_o}{f_e} = \frac{15}{0.10} = 150$$

Let D be diameter of moon, d diameter of image of moon formed by objective and r the distance of moon from objective lens, then from Fig.

$$\frac{D}{r} = \frac{d}{f_o}$$

$$d = \frac{D}{r} f_o = \frac{3.48 \times 10^6}{3.8 \times 10^8} \times 15 \text{ m} = 0.137 \text{ m} = 13.7 \text{ cm}$$

27. (i) **In series combinations**

$$\text{Net resistance, } R = R_1 + R_2 \quad \dots(i)$$

As heating elements are operated at same voltage V , we have

$$R = \frac{V^2}{P}, \quad R_1 = \frac{V^2}{P_1} \text{ and } R_2 = \frac{V^2}{P_2}$$

From equation (i)

$$\frac{V^2}{P} = \frac{V^2}{P_1} + \frac{V^2}{P_2} = \frac{1}{P} + \frac{1}{P_1} + \frac{1}{P_2}$$

(ii) In parallel combination

$$\begin{aligned} \text{Net resistance} &= \frac{1}{\frac{1}{R} + \frac{1}{R_1} + \frac{1}{R_2}} \\ &= \frac{P}{\frac{P}{V^2} + \frac{P_1}{V^2} + \frac{P_2}{V^2}} \end{aligned} \quad P = P_1 + P_2$$

28. (a) Principle: It works on the principle that a current carrying coil when kept inside a uniform magnetic field, can experience a torque.

When current (I) is passed in the coil, torque acts on the coil, given by

$$NIAB \sin \theta$$

where θ is the angle between the normal to plane of coil and the magnetic field of strength B , N is the number of turns in a coil.

When the magnetic field is radial, as in the case of cylindrical pole pieces and soft iron core, then in every position of coil the plane of the coil, is parallel to the magnetic field lines, so that

$$\theta = 90^\circ \text{ and } \sin 90^\circ = 1$$

Deflecting torque, $\tau = NIAB$

If C is the torsional rigidity of the wire and ϕ is the twist of suspension strip, then restoring torque $\tau_r = C\phi$

For equilibrium, deflecting torque = restoring torque

$$i.e. \quad NIAB = C\phi \quad \frac{NAB}{C} I \quad \dots(i)$$

$$i.e. \quad \phi = \frac{NAB}{C} I$$

deflection of coil is directly proportional to current flowing in the coil and hence we can construct a linear scale.

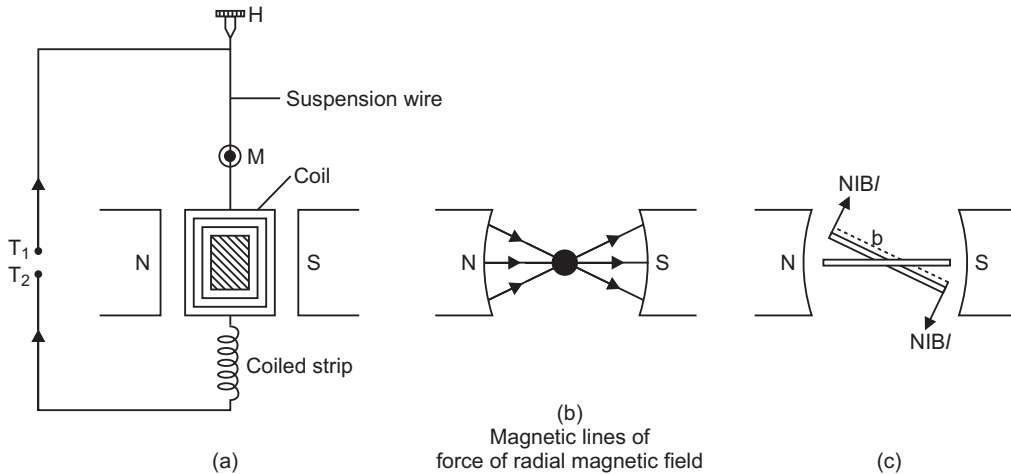

(b) Current sensitivity, $S_I = \frac{1}{I} \frac{NAB}{C} \dots (i)$

Voltage sensitivity, $S_V = \frac{1}{V} \frac{NAB}{GC} \dots (ii)$

Dividing (ii) by (i)

$$\frac{S_V}{S_I} = \frac{1}{G} \quad S_V = \frac{1}{G} S_I$$

Clearly the voltage sensitivity depends on current sensitivity and the resistance of galvanometer. If we increase current sensitivity and resistance G is larger, then it is not certain that voltage sensitivity will be increased. Thus, the increase of current sensitivity does not imply the increase of voltage sensitivity.

(c) **Conversion of galvanometer into ammeter:**

An ammeter is a low resistance galvanometer and is connected in series in a circuit to read current directly in 'a'.

The resistance of an ammeter is to be made as low as possible so that it may read current without any appreciable error. Therefore to convert a galvanometer into ammeter a **shunt resistance**.

(i.e. small resistance in parallel) is connected across the coil of galvanometer.

Let G be the resistance of galvanometer and I_g the current required for full scale deflection. Suppose this galvanometer is to be converted into ammeter of range I ampere and the value of shunt required is S. If I_S is current in shunt, then from fig.

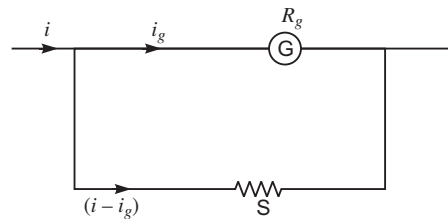

$$I - I_g = I_S \quad I_S = (I - I_g) \dots (i)$$

Also potential difference across A and B

$$(V_{AB}) = I_S \cdot S = I_g \cdot G$$

Substituting value of I_S from (i), we get

or $(I - I_g)S = I_g G$

or $IS - I_g S = I_g G$

or $IS = I_g (S + G)$

or $I_g = \frac{S}{S + G} I \dots (ii)$

i.e. shunt required, $S = \frac{GI_g}{I - I_g} \dots (iii)$

This is the working equation of conversion of galvanometer into ammeter.

OR

(a) **Magnetic Field Due to a Current Carrying Long Solenoid:**

A solenoid is a long wire wound in the form of a close-packed helix, carrying current. To construct a solenoid a large number of closely packed turns of insulated copper wire are wound on a cylindrical tube of card-board or china clay. When an electric current is passed through the solenoid, a magnetic field is produced within the solenoid. If the solenoid is long

and the successive insulated copper turns have no gaps, then the magnetic field within the solenoid is uniform; with practically no magnetic field outside it. The reason is that the solenoid may be supposed to be formed of a large number of circular current elements. The magnetic field due to a circular loop is along its axis and the current in upper and lower straight parts of solenoid is equal and opposite. Due to this the magnetic field in a direction perpendicular to the axis of solenoid is zero and so the resultant magnetic field is along the axis of the solenoid.

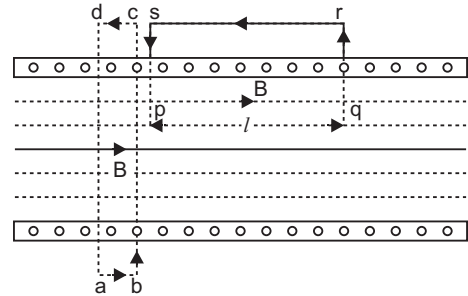

If there are 'n' number of turns per metre length of solenoid and I amperes is the current flowing, then magnetic field at axis of long solenoid

$$B = \mu_0 nI$$

If there are N turns in length l of wire, then

$$n = \frac{N}{l}$$

or

$$B = \frac{\mu_0 NI}{l}$$

Derivation: Consider a symmetrical long solenoid having number of turns per unit length equal to n.

Let I be the current flowing in the solenoid, then by right hand rule, the magnetic field is parallel to the axis of the solenoid.

Field outside the solenoid: Consider a closed path abcd. Applying Ampere's law to this path

$$\oint B \cdot dl = 0 \text{ (since net current enclosed by path is zero)}$$

$$\text{As } \int_{cd} B \cdot dl = 0 \text{ and } \int_{da} B \cdot dl = 0$$

This means that the magnetic field outside the solenoid is zero.

Field Inside the solenoid: Consider a closed path pqrs. The line integral of magnetic field B along path pqrs is

$$\oint_{pqrs} B \cdot dl = \int_{pq} B \cdot dl + \int_{qr} B \cdot dl + \int_{rs} B \cdot dl + \int_{sp} B \cdot dl \dots(i)$$

For path pq, B and dl are along the same direction,

$$\int_{pq} B \cdot dl = B \int_{pq} dl = Bl \text{ (pq = l say)}$$

For paths qr and sp, B and dl are mutually perpendicular.

$$\int_{qr} B \cdot dl = \int_{sp} B \cdot dl = B \int dl \cos 90^\circ = 0$$

For path rs , $B \cdot dl = 0$ (since field is zero outside a solenoid)

$$\int_{rs} B \cdot dl = 0$$

In view of these, equation (i) gives

$$\int_{pqrs} B \cdot dl = \int_{pq} B \cdot dl = Bl \quad \dots(ii)$$

By Ampere's law $\oint B \cdot dl = \mu_0$ net current enclosed by path

$$Bl = \mu_0 (nl I) \quad B = \mu_0 nl$$

- (b) In a toroid, magnetic lines do not exist outside the body. Toroid is closed whereas solenoid is open on both sides. Magnetic field is uniform inside a toroid whereas for a solenoid, it is different at the two ends and centre. (Any one)

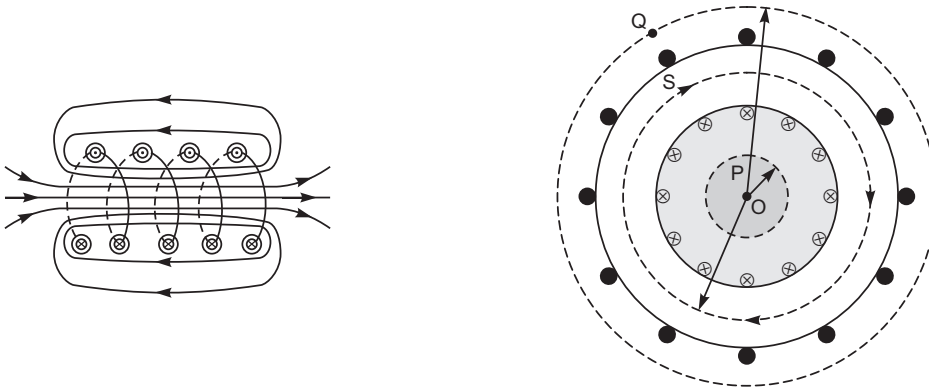

- (c) The magnetic field lines of toroid are circular having common centre. Inside a given solenoid, the magnetic field may be made strong by
- (i) passing large current and
 - (ii) using laminated coil of soft iron.

29. Working: When the armature coil is rotated in the strong magnetic field, the magnetic flux linked with the coil changes and the current is induced in the coil, its direction being given by Fleming's right hand rule. Considering the armature to be in vertical position and as it rotates in anticlockwise direction, the wire ab moves upward and cd downward, so that the direction of induced current is shown in fig. In the external circuit, the current flows along $B_1 R_L B_2$. The direction of current remains unchanged during the first half turn of armature. During the second half revolution, the wire ab moves downward and cd upward, so the direction of current is reversed and in external circuit it flows along $B_2 R_L B_1$. Thus the direction of induced emf and current changes in the external circuit after each half revolution.

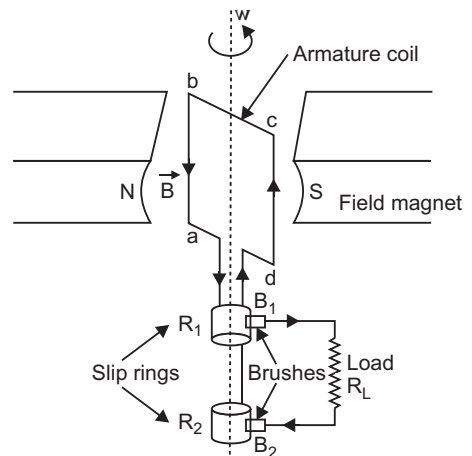

If N is the number of turns in coil, f the frequency of rotation, A area of coil and B the magnetic induction, then induced emf

$$e = \frac{d}{dt} \frac{d}{dt} \{NBA (\cos 2 \pi f t)\}$$

$$= 2 \pi NBA f \sin 2 \pi f t$$

Obviously, the emf produced is alternating and hence the current is also alternating.

Current produced by an ac generator cannot be measured by moving coil ammeter; because the average value of ac over full cycle is zero.

The source of energy generation is the mechanical energy of rotation of armature coil.

OR

(a) **AC circuit containing pure inductance:** Consider a coil of self-inductance L and negligible ohmic resistance. An alternating potential difference is applied across its ends. The magnitude and direction of AC changes periodically, due to which there is a continual change in magnetic flux linked with the coil. Therefore according to Faraday's law, an induced emf is produced in the coil, which opposes the applied voltage. As a result the current in the circuit is reduced. That is **inductance acts like a resistance in ac circuit**. The instantaneous value of alternating voltage applied

$$V = V_0 \sin \omega t \tag{... (i)}$$

If i is the instantaneous current in the circuit and $\frac{di}{dt}$, the rate of change of current in the circuit at that instant, then instantaneous induced emf

$$= L \frac{di}{dt}$$

According to Kirchoff's second law in closed circuit.

$$V - 0 = V - L \frac{di}{dt} = 0$$

or $V = L \frac{di}{dt}$ or $\frac{di}{dt} = \frac{V}{L}$

or $\frac{di}{dt} = \frac{V_0 \sin \omega t}{L}$ or $di = \frac{V_0 \sin \omega t}{L} dt$

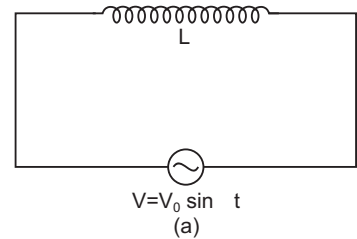

Integrating with respect to time 't',

$$i = \frac{V_0}{L} \int \sin \omega t dt = \frac{V_0}{L} \left[-\frac{\cos \omega t}{\omega} \right] = -\frac{V_0}{L \omega} \cos \omega t$$

$$= \frac{V_0}{L \omega} \sin \left(\omega t - \frac{\pi}{2} \right)$$

or $i = \frac{V_0}{L \omega} \sin \left(\omega t - \frac{\pi}{2} \right)$... (ii)

This is required expression for current

or $i = i_0 \sin \left(\omega t - \frac{\pi}{2} \right)$... (iii)

where $i_0 = \frac{V_0}{L}$...*(iv)*

is the peak value of alternating current

Also comparing *(i)* and *(iii)*, we note that current lags behind the applied voltage by an angle $\frac{\pi}{2}$.

(b) *(i)* Induced emf $= B_H v L$

Where B is horizontal component of earth's magnetic field directed from S to N.

(ii) West to east.

(iii) East-end will be at higher potential.

30. If coherent sources are not taken, the phase difference between two interfering waves, will change continuously and a sustained interference pattern will not be obtained. Thus, coherent sources provide sustained interference pattern.

Suppose two coherent waves travel in the same direction along a straight line, the frequency of each wave is $\frac{\omega}{2\pi}$ and amplitudes of electric field are a_1 and a_2 respectively. If at any time t , the electric fields of waves at a point are y_1 and y_2 respectively and phase difference is ϕ , then equation of waves may be expressed as

$$y_1 = a_1 \sin(\omega t) \quad \dots(i)$$

$$y_2 = a_2 \sin(\omega t + \phi) \quad \dots(ii)$$

According to Young's principle of superposition, the resultant displacement at that point will be

$$y = y_1 + y_2 \quad \dots(iii)$$

Substituting values of y_1 and y_2 from *(i)* and *(ii)* in *(iii)*, we get

$$y = a_1 \sin \omega t + a_2 \sin(\omega t + \phi)$$

Using trigonometric relation

$$\sin(\omega t + \phi) = \sin \omega t \cos \phi + \cos \omega t \sin \phi,$$

we get $y = a_1 \sin \omega t + a_2 (\sin \omega t \cos \phi + \cos \omega t \sin \phi)$

$$(a_1 + a_2 \cos \phi) \sin \omega t + (a_2 \sin \phi) \cos \omega t \quad \dots(iv)$$

Let $a_1 + a_2 \cos \phi = A \cos \alpha$...*(v)*

And $a_2 \sin \phi = A \sin \alpha$...*(vi)*

where A and α are new constants.

Then equation *(iv)* gives $y = A \cos(\omega t - \alpha) = A \sin(\omega t + \phi) \quad \dots(vii)$

This is the equation of the resultant disturbance. Clearly the amplitude of resultant disturbance is A and phase difference from first wave is α . The values of A and α are determined by *(v)* and *(vi)*.

Squaring *(v)* and *(vi)* and then adding, we get

$$(a_1 + a_2 \cos \phi)^2 + (a_2 \sin \phi)^2 = A^2 \cos^2 \alpha + A^2 \sin^2 \alpha$$

or $a_1^2 + a_2^2 \cos^2 \phi + 2a_1 a_2 \cos \phi + a_2^2 \sin^2 \phi = A^2 (\cos^2 \alpha + \sin^2 \alpha)$

As $\cos^2 \alpha + \sin^2 \alpha = 1$, we get

$$A^2 = a_1^2 + a_2^2 (\cos^2 \phi + \sin^2 \phi) + 2a_1 a_2 \cos \phi$$

or $A^2 = a_1^2 + a_2^2 + 2a_1 a_2 \cos \phi$

$$\text{Amplitude, } A = \sqrt{a_1^2 + a_2^2 + 2a_1a_2 \cos \phi} \quad \dots(\text{viii})$$

As the intensity of a wave is proportional to its amplitude *i.e.* $I \propto A^2$ or $I = KA^2$ watt / m² where K is a constant which depends on properties of medium and the frequency of wave. In interference the frequencies of two waves are same and medium is same, therefore for convenience, we may take, $K = 1$, then the units of intensity I will not be watt / m² but arbitrary.

Intensity of resultant wave

$$I = A^2 = a_1^2 + a_2^2 + 2a_1a_2 \cos \phi \quad \dots(\text{ix})$$

Clearly the intensity of resultant wave at any point depends on the amplitudes of individual waves and the phase difference between the waves at the point.

Constructive Interference: For maximum intensity at any point $\cos \phi = 1$

or phase difference $\phi = 0, 2\pi, 4\pi, 6\pi, \dots$
 $2n\pi \quad (n = 0, 1, 2, \dots) \quad \dots(\text{x})$

The maximum intensity,

$$I_{\max} = a_1^2 + a_2^2 + 2a_1a_2 = (a_1 + a_2)^2 \quad \dots(\text{xi})$$

Path difference $\frac{\phi}{2\pi} = n$ Phase difference $\phi = 2n\pi \quad n = 0, 1, 2, \dots \quad \dots(\text{xii})$

Clearly the maximum intensity is obtained in the region of superposition at those points where waves meet in the same phase or the phase difference between the waves is even multiple of π or path difference between them is the integral multiple of λ and maximum intensity is $(a_1 + a_2)^2$ which is greater than the sum intensities of individual waves by an amount $2a_1a_2$.

Destructive Interference: For minimum intensity at any point $\cos \phi = -1$

or phase difference, $\phi = \pi, 3\pi, 5\pi, 7\pi, \dots$
 $(2n + 1)\pi \quad , n = 1, 2, 3, \dots \quad \dots(\text{xiii})$

In this case the minimum intensity,

$$I_{\min} = a_1^2 + a_2^2 - 2a_1a_2 = (a_1 - a_2)^2 \quad \dots(\text{xiv})$$

Path difference, $\frac{\phi}{2\pi} = n + \frac{1}{2}$ Phase difference $\phi = (2n + 1)\pi$
 $\frac{\phi}{2\pi} = (2n + 1) \frac{\lambda}{2} \quad \dots(\text{xv})$

Clearly, the minimum intensity is obtained in the region of superposition at those points where waves meet in opposite phase or the phase difference between the waves is odd multiple of π or path difference between the waves is odd multiple of $\frac{\lambda}{2}$ and minimum intensity $(a_1 - a_2)^2$ which is less than the sum of intensities of the individual waves by an amount $2a_1a_2$.

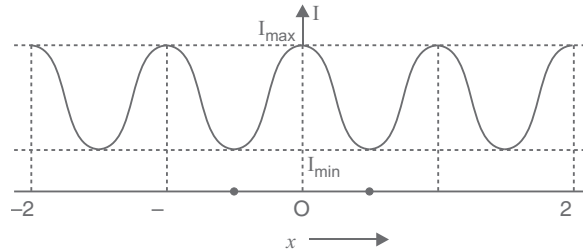

From equations (xii) and (xvi) it is clear that the intensity $2a_1a_2$ is transferred from positions of minima to maxima. This implies that the **interference is based on conservation of energy**.

Variation of Intensity of light with position x is shown in fig.

Expression for Fringe Width: Let S_1 and S_2 be two coherent sources separated by a distance d . Let the distance of the screen from the coherent sources be D . Let M be the foot of the perpendicular drawn from O , the midpoint of S_1 and S_2 on the screen. Obviously point M is equidistant from S_1 and S_2 . Therefore the path difference between the two waves at point M is zero. Thus the point M has the maximum intensity. Consider a point P on the screen at a distance y from M . Draw S_1N perpendicular from S_1 on S_2P .

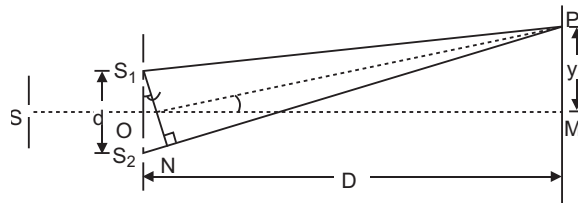

The path difference between two waves reaching at P from S_1 and S_2 is $S_2P - S_1P$. As $D \gg d$, therefore $S_2P - S_1P$ is very small.

In $\triangle S_1S_2N$, $\sin \theta = \frac{S_2N}{S_1S_2}$

In $\triangle MOP$, $\tan \theta = \frac{MP}{OM}$

As θ is very small $\sin \theta \approx \tan \theta$

$\frac{S_2N}{S_1S_2} \approx \frac{MP}{OM}$

$S_2N \approx S_1S_2 \frac{MP}{OM} = d \cdot \frac{y}{D}$

Path difference $S_2P - S_1P = S_2N = \frac{y d}{D}$... (i)

(i) **Positions of bright fringes (or maxima):** For bright fringe or maximum intensity at P , the path difference must be an integral multiple of wavelength (λ) of light used. *i.e.* $\frac{y d}{D} = n \lambda$

$$\frac{yd}{D} = n, n = 0, 1, 2, 3, \dots$$

$$y = \frac{nD}{d}.$$

This equation gives the distance of n th bright fringe from the point M . Therefore writing y_n for y , we get

$$y_n = \frac{nD}{d}. \quad \dots(ii)$$

(ii) Positions of dark fringes (or minima): For dark fringe or minimum intensity at P , the path difference must be an odd number multiple of half wavelength. *i.e.* $(2n - 1) \frac{\lambda}{2}$

$$\frac{y \cdot d}{D} = (2n - 1) \frac{\lambda}{2} \text{ where } n = 1, 2, 3, \dots$$

or
$$y = \frac{(2n - 1) D}{2d} = (n - \frac{1}{2}) \frac{D}{d}.$$

This equation gives the distance of n th dark fringe from point M . Therefore writing y_n for y , we get

$$y_n = (n - \frac{1}{2}) \frac{D}{d} \quad \dots(iii)$$

(iii) Fringe Width : The distance between any two consecutive bright fringes or any two consecutive dark fringes is called the **fringe width**. It is denoted by β .

For Bright Fringes: If y_{n-1} and y_n denote the distances of two consecutive bright fringes from M , then we have

$$y_{n-1} = (n - 1) \frac{D}{d} \text{ and } y_n = \frac{nD}{d}$$

$$\text{Fringe width, } \beta = y_n - y_{n-1} = (n - 1) \frac{D}{d} + \frac{nD}{d} - \frac{D}{d}. \quad \dots(iv)$$

For Dark Fringes: If y_{n-1} and y_n are the distances of two consecutive dark fringes from M , then we have

$$y_{n-1} = (n - \frac{1}{2}) \frac{D}{d}, y_n = (n - \frac{1}{2}) \frac{D}{d}$$

$$\text{Fringe width, } \beta = y_n - y_{n-1} = (n - \frac{1}{2}) \frac{D}{d} - (n - \frac{1}{2}) \frac{D}{d}$$

$$\frac{D}{d} (n - \frac{1}{2}) - (n - \frac{1}{2}) \frac{D}{d} \quad \dots(v)$$

Thus, fringe width is the same for bright and dark fringes equal to

$$\frac{D}{d}$$

When entire apparatus is immersed in water, the fringe-width decreases ($\beta_w < \beta_a$).

OR

(a) Huygen’s principle is useful for determining the position of a given wavefront at any time in the future if we know its present position. The principle may be stated in three parts as follows:

- (i) Every point on a given wavefront may be regarded as a source of new disturbance.
- (ii) The new disturbances from each point spread out in all directions with the velocity of light and are called the *secondary wavelets*.
- (iii) The surface of tangency to the secondary wavelets in forward direction at any instant gives the new position of the wavefront at that time.

Diffraction of light at a single slit: When monochromatic light is made incident on a single slit, we get diffraction pattern on a screen placed behind the slit. The diffraction pattern contains bright and dark bands, the intensity of central band is maximum and goes on decreasing on both sides.

Explanation: Let AB be a slit of width ‘ a ’ and a parallel beam of monochromatic light is incident on it. According to Fresnel the diffraction pattern is the result of superposition of a large number of waves, starting from different points of illuminated slit.

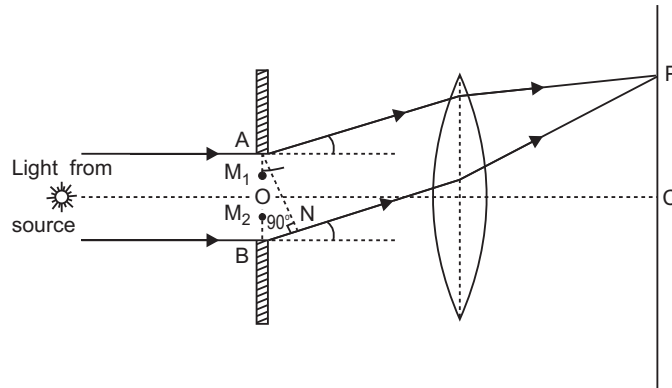

Let θ be the angle of diffraction for waves reaching at point P of screen and AN the perpendicular dropped from A on wave diffracted from B .

The path difference between rays diffracted at points A and B ,

$$BP - AP = BN$$

In $\triangle ANB$, $\angle ANB = 90^\circ$ and $\angle BAN = \theta$

$$\sin \theta = \frac{BN}{AB} \text{ or } BN = AB \sin \theta$$

As $AB =$ width of slit $= a$

Path difference,

$$a \sin \theta \quad \dots(i)$$

To find the effect of all coherent waves at P , we have to sum up their contribution, each with a different phase. This was done by Fresnel by rigorous calculations, but the main features may be explained by simple arguments given below:

At the central point C of the screen, the angle θ is zero. Hence the waves starting from all points of slit arrive in the same phase. This gives maximum intensity at the central point C .

If point P on screen is such that the path difference between rays starting from edges A and B is $a \sin \theta$, then path difference

$$a \sin \theta = \frac{a \sin \theta}{a}$$

If angle θ is small, $\sin \theta \approx \theta$...*(ii)*

Minima: Now we divide the slit into two equal halves AO and OB , each of width $\frac{a}{2}$. Now for every point, M_1 in AO , there is a corresponding point M_2 in OB , such that $M_1M_2 = \frac{a}{2}$; Then path difference between waves arriving at P and starting from M_1 and M_2 will be $\frac{a}{2} \sin \theta = \frac{a \sin \theta}{2}$. This means that the contributions from the two halves of slit AO and OB are opposite in phase and so cancel each other. Thus equation (2) gives the angle of diffraction at which intensity falls to zero. Similarly it may be shown that the intensity is zero for $\sin \theta = \frac{n \lambda}{a}$, with n as integer. Thus the general condition of **minima** is

$$a \sin \theta = n \lambda \quad \dots\text{(iii)}$$

Secondary Maxima: Let us now consider angle θ such that

$$\sin \theta = \frac{3 \lambda}{2a}$$

which is midway between two dark bands given by

$$\sin \theta = \frac{\lambda}{a} \text{ and } \sin \theta = \frac{2 \lambda}{a}$$

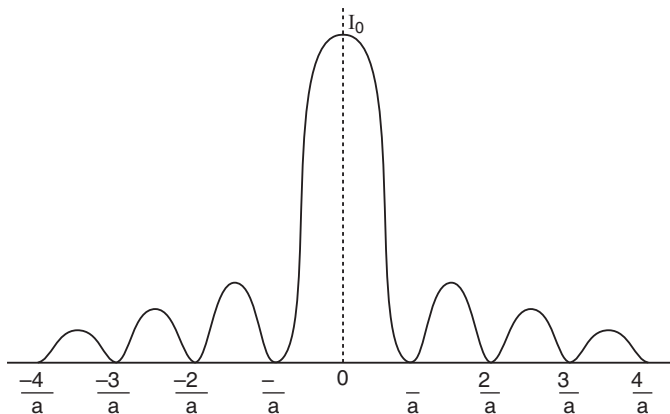

(b) Angular width of central maximum $(\theta)_C = \frac{2\lambda}{a}$

Angular width of first maximum, $(\theta)_I = \frac{2\lambda}{a} - \frac{\lambda}{a}$

$$(\theta)_C = \frac{1}{2} (\theta)_I$$

Hence, the fringe width of the first diffraction fringe is half that of the central fringe.

- (c) If monochromatic light is replaced by white light, each diffraction band gets splitted into the number of coloured bands, the angular width of violet is least and that of red is maximum.

CBSE (All India) SET-II

- 5 V.
- X-rays are produced by sudden deceleration or acceleration of electrons./In an X-ray tube.
- Angle of dip is zero at equator of earth's surface.

9. In series, $C_S = \frac{C}{3}$

In parallel, $C_P = 3C$

$$\frac{C_P}{C_S} = 9$$

$$C_P = 9 \times \frac{2}{18} F = 1 F$$

Required ratio $\frac{E_S}{E_P} = \frac{\frac{1}{2} C_S V^2}{\frac{1}{2} C_P V^2} = \frac{C_S}{C_P} = \frac{2}{18} = \frac{1}{9}$.

12. Working of a transformer is based on the principle of mutual induction. Transformer cannot step up or step down a dc voltage.

Reason: No change in magnetic flux.

Explanation: When dc voltage source is applied across a primary coil of a transformer, the current in primary coil remains same, so there is no change in magnetic flux and hence no voltage is induced across the secondary coil.

14. Current in 2 Ω resistor, $I = 2$ A

Applying Kirchoff's law along the path ACDB

$$V_A - 2 - 2 - 2 - 4 - V_B = 0$$

$$V_B - V_A = -2 - 0 - 2 - 2 = -6V$$

17. The mode of wave propagation in which wave glides over the surface of the earth is called ground wave communication.

The maximum range of propagation in this mode depends on

- transmitted power and
- frequency (less than a few MHz)

21. The circuit represents OR gate.

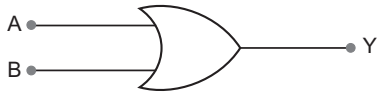

Truth table

A	B	$X = \bar{A}$	$Y = \bar{B}$	Z
0	0	1	1	0
0	1	1	0	1
1	0	0	1	1
1	1	0	0	1

CBSE (All India) SET-III

1. 12 V
3. Microwaves are produced by special vacuum tubes, namely, klystrons, Gunn diodes, magnetrons, etc.
7. At magnetic equator.
12. Energy losses in a transformer are due to
 - (i) Flux leakage
 - (ii) Joule heating in resistance of winding
 - (iii) Eddy currents
 - (iv) Hysteresis
14. Current in 2 resistor is 3 A
 $V_A + 3 + 3 \times 2 - 6 = V_B$
 $V_B - V_A = 3 - 0 = 3 \text{ V}$
16. When a wave propagates in a straight line, from the transmitting antenna to the receiving antenna, its mode of propagation is called space wave communication.

Frequency range: Above 40 MHz.

20. $f_l = \frac{a n_g - 1}{a n_l - 1} f_a$

$$= \frac{1.6 - 1}{1.3 - 1} \times 20 \text{ cm cm}$$

$$= \frac{0.6}{0.3} \times 20 \text{ cm}$$

$$= 52 \text{ cm}$$

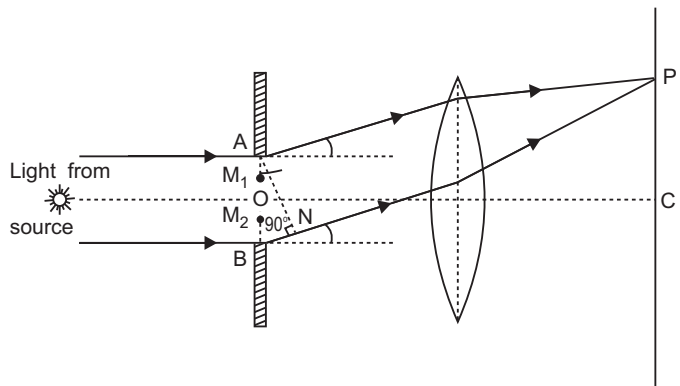

22. $y = \overline{\overline{A} \cdot \overline{B}} = \overline{\overline{A}} \cdot \overline{\overline{B}} = AB$

The circuit represents AND gate.

Logic symbol:

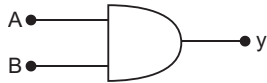

Truth table:

A	B	Y
0	0	0
1	0	0
0	1	0
1	1	1

CBSE EXAMINATION PAPERS

FOREIGN-2011

Time allowed: 3 hours

Maximum marks: 70

General Instructions:

- All questions are compulsory.
- There are 30 questions in total. Questions 1 to 8 carry one mark each, questions 9 to 18 carry two marks each, questions 19 to 27 carry three marks each and questions 28 to 30 carry five marks each.
- There is no overall choice. However, an internal choice has been provided in one question of two marks, one question of three marks and all three questions of five marks each. You have to attempt only one of the given choices in such questions.
- Use of calculators is not permitted.
- You may use the following values of physical constants wherever necessary:

$$c = 3 \times 10^8 \text{ ms}^{-1}$$

$$h = 6.626 \times 10^{-34} \text{ Js}$$

$$e = 1.602 \times 10^{-19} \text{ C}$$

$$\mu_0 = 4\pi \times 10^{-7} \text{ TmA}^{-1}$$

$$\frac{1}{4\pi\epsilon_0} = 9 \times 10^9 \text{ Nm}^2\text{C}^{-2}$$

$$\text{Boltzmann's constant } k = 1.381 \times 10^{-23} \text{ JK}^{-1}$$

$$\text{Avogadro's number } N_A = 6.022 \times 10^{23} / \text{mole}$$

$$\text{Mass of neutron } m_n = 1.675 \times 10^{-27} \text{ kg}$$

$$\text{Mass of electron } m_e = 9.1 \times 10^{-31} \text{ kg}$$

$$\text{Radius of earth} = 6400 \text{ km}$$

CBSE (Foreign) SET-I

- Define the term 'threshold frequency' in relations to photoelectric effects.
- The peak value of e.m.f. in a.c. is E_0 . Write its (i) rms (ii) average value over a complete cycle.
- Two insulated charged copper spheres A and B of identical size have charges q_A and q_B respectively. A third sphere C of the same size but uncharged is brought in contact with the first and then in contact with the second and finally removed from both. What are the new charges on A and B?
- A narrow beam of protons and deuterons, each having the same momentum, enters a region of uniform magnetic field directed perpendicular to their direction of momentum. What would be the ratio of the circular paths described by them?
- What is the function of 'Repeater' in communication system?
- Draw the logic circuit of NAND gate and write its truth table.
- How is the mean life of a radioactive sample related to its half life?
- Write two uses of microwaves.

9. Calculate the amount of work done in rotating a dipole, of dipole moment 3×10^{-8} cm, from its position of stable equilibrium to the position of unstable equilibrium, in a uniform electric field of intensity 10^4 N/C.
10. Plot a graph showing temperature dependence of resistivity for a typical semiconductor. How is this behaviour explained?
11. When four hydrogen nuclei combine to form a helium nucleus, estimate the amount of energy in MeV released in this process of fusion (Neglect the masses of electrons and neutrinos) Given:
 - (i) mass of ${}^1_1\text{H} = 1.007825$ u
 - (ii) mass of helium nucleus = 4.002603 u, $1\text{u} = 931$ MeV / c^2
12. For an amplitude modulated wave, the maximum amplitude is found to be 10 V while the minimum amplitude is 2 V. Calculate the modulation index. Why is modulation index generally kept less than one?
13. Draw a block diagram showing the important components in a communication system. What is the function of a transducer?
14. Explain the following:
 - (i) Why do magnetic lines of force form continuous closed loops?
 - (ii) Why are the field lines repelled (expelled) when a diamagnetic material is placed in an external uniform magnetic field?

OR

- (i) Name the three elements of the Earth's magnetic field.
 - (ii) Where on the surface of the Earth is the vertical component of the Earth's magnetic field zero?
15. Show how the equation for Ampere's circuital law, viz.

$$\oint B \cdot dl = \mu_0 I$$

16. Current in a circuit falls steadily from 5.0 A to 0.0 A in 100 ms. If an average e.m.f. of 200 V is induced, calculate the self-inductance of the circuit.
17. (a) You are required to select a carbon resistor of resistance $47 k \pm 10\%$ from a large collection. What should be the sequence of colour bands used to code it?
 (b) Write the characteristics of manganin which make it suitable for making standard resistance.
18. Two identical parallel plate (air) capacitors C_1 and C_2 have capacitances C each. The between their plates is now filled with dielectrics as shown. If the two capacitors still have equal capacitance, obtain the relation between dielectric constants K , K_1 and K_2 .

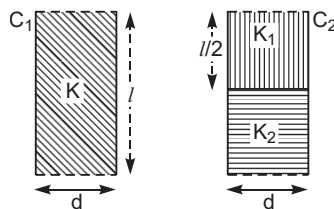

19. State the principal of the device that can build up high voltages of the order of a few million volts. Draw its labelled diagram. A stage reaches in this device when the potential at the outer sphere cannot be increased further by piling up more charge on it. Explain why?
20. Light of wavelength 2000 \AA falls on a metal surface of work functions 4.2 eV . What is the kinetic energy (in eV) of the fastest electrons emitted from the surface?
- (i) What will be the change in the energy of the emitted electrons if the intensity of light with same wavelength is doubled?
- (ii) If the same light falls on another surface of work functions 6.5 eV , what will be the energy of emitted electrons?
21. Name the important process that occur during the formation of a p-n junction. Explain briefly, with the help of a suitable diagram, how a p-n junction is formed. Define the term 'barrier potential'.
22. The intensity at the central maxima (O) in a Young's double slit experiment is I_0 . If the distance OP equals one-third of the fringe width of the pattern, show that the intensity at point P would be $\frac{I_0}{4}$.

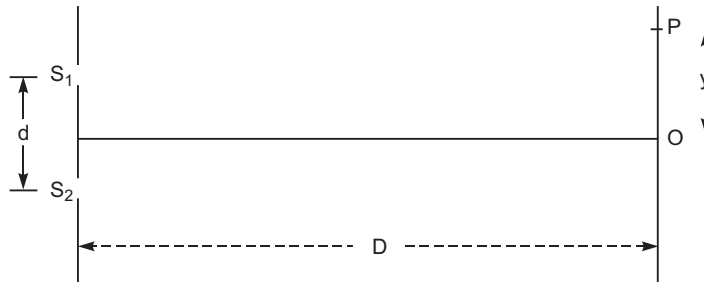

OR

In the experiment on diffraction due to a single slit, show that

- (i) the intensity of diffraction fringes decreases as the order (n) increases.
- (ii) angular width of the central maximum is twice that of the first order secondary maximum.
23. Find the position of the image formed of the object 'O' by the lens combination given in the figure.

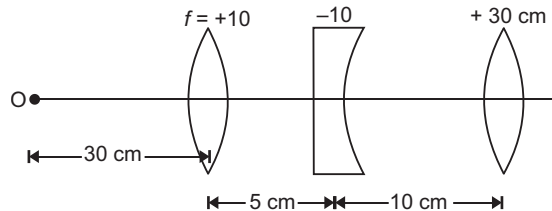

24. Draw transfer characteristics of common emitter n-p-n transistor. Point out the region in which the transistor operates as an amplifier. Define the following terms used in transistor amplifiers:
- (i) Input resistance
- (ii) Output resistance
- (iii) Current amplification factor
25. (i) Light passes through two polaroids P_1 and P_2 with axis of P_2 making an angle with the pass axis of P_1 . For what value of is the intensity of emergent light zero?

(ii) A third polaroid is placed between P_1 and P_2 with its pass axis making an angle θ with the pass axis of P_1 . Find a value of θ for which the intensity of light emerging from P_2 is $\frac{I_0}{8}$, where I_0 is the intensity of light on the polaroid P_1 .

26. Using the postulates of Bohr's model of hydrogen atom, obtain an expression for the frequency of radiation emitted when atom make a transition from the higher energy state with quantum number n_i to the lower energy state with quantum number n_f ($n_f < n_i$).
27. State the underlying principal of potentiometer. Describe briefly, giving the necessary circuit diagram, how a potentiometer is used to measure the internal resistance of a given cell.
28. (a) Show that a planar loop carrying a current I , having N closely wound turns and area of cross-section A , possesses a magnetic moment $m = N I A$.
- (b) When this loop is placed in a magnetic field B , find out the expression for the torque acting on it.
- (c) A galvanometer coil of $50\ \Omega$ resistance shows full scale deflection for a current of $5\ \text{mA}$. How will you convert this galvanometer into a voltmeter of range 0 to $15\ \text{V}$?

OR

- (a) Draw a schematic sketch of a cyclotron, explain its working principal and deduce the expression for the kinetic energy of the ions accelerated.
- (b) Two long and parallel straight wires carrying currents of $2\ \text{A}$ and $5\ \text{A}$ in the opposite directions are separated by a distance of $1\ \text{cm}$. Find the nature and magnitude of the magnetic force between them.
29. (a) Derive the expression for the mutual inductance of two long coaxial solenoids of same length l having radii r_1 and r_2 ($r_2 < r_1$ and $l \gg r_2$).
- (b) Show that mutual inductance of solenoid 1 due to solenoid 2, M_{12} , is the same as that of 2 due to 1 i.e., M_{21} .
- (c) A power transmission line feeds power at $2200\ \text{V}$ with a current of $5\ \text{A}$ to a step down transformer with its primary winding having 4000 turns. Calculate the number of turns and the current in the secondary in order to get output power at $220\ \text{V}$.

OR

- (a) An alternating voltage $v = v_m \sin \omega t$ applied to a series LCR circuit drives a current given by $i = i_m \sin (\omega t - \phi)$. Deduce an expression for the average power dissipated over a cycle.
- (b) For circuits used for transporting electric power, a low power factor implies large power loss in transmission. Explain.
- (c) Determine the current quality factor at resonance for a series LCR circuit with $L = 1.00\ \text{mH}$, $1.00\ \text{nF}$ and $R = 100\ \Omega$ connected to an a.c. source having peak voltage of $100\ \text{V}$.
30. (i) A plane wavefront approaches a plane surface separating two media. If medium 'one' is optically denser and medium 'two' is optically rarer, using Huygens' principle, explain and show how a refracted wavefront is constructed.
- (ii) Hence verify Snell's law.
- (iii) When a light wave travels from rarer to denser medium, the speed decreases. Does it imply reduction its energy? Explain.

OR

- (i) A ray of monochromatic light is incident on one of the faces of an equilateral triangular prism of refracting angle A . Trace the path of ray passing through the prism. Hence, derive an expression for the refractive index of the material of the prism in terms of the angle minimum deviation and its refracting angle.
- (ii) Three light rays red (R), green (G) and blue (B) are incident on the right angled prism abc at face ab . The refractive indices of the material of the prism for red, green and blue wavelengths are respectively 1.39, 1.44 and 1.47. Trace the paths of these rays reasoning out the difference in their behaviour.

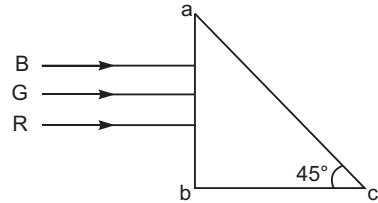

CBSE (Foreign) SET-II

Questions uncommon to Set-I.

- The current flowing through a pure inductor of inductance 4 mH is $i = 12 \cos 300t$ ampere. What is (i) rms and (ii) average value of the current for a complete cycle?
- Show the variation of photocurrent with collector plate potential for different frequencies but same intensity of incident radiation.
- Two insulated charged copper spheres A and B of identical size have charges q_A and q_B respectively. When they are brought in contact with each other and finally separated, what are the new charges on them?
- What is the function of a transmitter in a communication system?
- Write two uses of infrared rays.
- Draw the logic circuit of AND gate and write its truth table.
- Calculate the amount of work done in rotating a dipole, of dipole moment 5×10^{-8} cm, from its position of stable equilibrium to the position of unstable equilibrium, in electric field of intensity 10^4 N/C.
- For an amplitude wave, the maximum amplitude is found to be 12 V while the minimum the amplitude is 2V. Calculate the modulation index. Why is modulation index generally kept low?
- You are given an air filled parallel plate capacitor C_1 . The space between its plates is now filled with slabs of dielectric constants K_1 and K_2 as shown in C_2 . Find the capacitances of the capacitor C_2 if area of the plates is A distance between the plates is d .

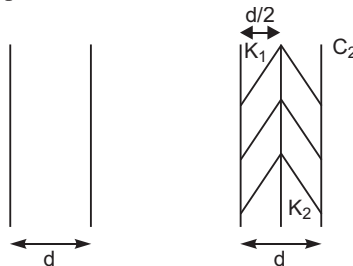

15. Current in a circuit steadily from 2.0 A to 0.0 A in 10 ms. If an average e.m.f. of 200V is induced, calculate the self-inductance of the circuit.
27. Light of wavelength 2500 \AA falls on a metal surface of work function 3.5 V. What is the kinetic energy (in eV) of (i) the fastest and (ii) the slowest electronic emitted from the surface?
If the same light falls on another surface of work function 5.5 eV, what will be the energy of emitted electrons?

CBSE (Foreign) SET-III

Questions uncommon to Set-I & II.

2. Show the variation of photocurrent with collector plate potential for different intensity but same frequency of incident radiation.
3. Two insulated charged copper spheres *A* and *B* of identical size have charges q_A and $3q_A$ respectively. When they are brought in contact with each other and then separated, what are the new charges on them?
4. The current flowing through a pure inductor of inductance 2 mH is $i = 15 \cos 300t$ ampere. What is the (i) rms and (ii) average value of current for a complete cycle?
6. Draw the logic circuit of NOT gate and write its truth table.
7. What is the function of a Receiver in a communication system?
8. Write two uses of X-rays.
9. Calculate the amount of work done in rotating a dipole, of dipole moment $2 \times 10^{-8} \text{ cm}$, from its position of stable equilibrium to the position of unstable equilibrium, in uniform electric field of intensity $5 \times 10^4 \text{ N/C}$.
12. You are given an air filled parallel plate capacitor C_1 . The space between its plates is now filled with slabs of dielectric constants K_1 and K_2 as shown in C_2 . Find the capacitances of the capacitor C_2 if area of the plates is A and distance between the plates is d .

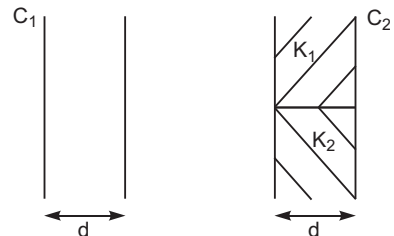

14. Current in a circuit falls steadily from 3.0 to 0.0 A in 300 ms. If an average e.m.f. of 200 V is induced, the self-inductance of the circuit.
15. For an amplitude modulated wave the maximum amplitude is found to be 15 V While the minimum amplitude is 3V. Calculate the modulation index. Why is modulation index generally kept less than one?
26. Light of wavelength 2400 \AA falls on a metal surface of work function 3.6 eV. What is the kinetic energy (in eV) of (i) the fastest and (ii) the slowest electrons emitted from the surface?
If the same light falls on another surface of work function 5.5 eV, what will be the energy of emitted electrons?

Solutions

CBSE (Foreign) SET-I

1. Threshold frequency is defined as the minimum frequency of incident radiation which can cause photoelectric emission. It is different for different metal .

2. E_0 peak value of emf

(i) rms value $[E_{rms}] = \frac{E_0}{\sqrt{2}}$

(ii) average value $[E_{av}] = \text{zero}$

3. New charge on A is $\frac{q_A}{2}$ and New charge on B is $\frac{q_A}{4}$

4. Charge on deuteron (q_d) = charge on proton (q_p)

$$q_d = q_p$$

$$\text{Radius of circular path } (r) = \frac{P}{Bq} \quad \because qvB = \frac{mv^2}{r}$$

$$r = \frac{1}{q} \quad [\text{for constant momentum (P)}]$$

so, $\frac{r_p}{r_d} = \frac{q_d}{q_p} = \frac{q_p}{q_p} = 1$

Hence, $r_p : r_d = 1 : 1$

5. A repeater which is a combination of a transmitter, an amplifier and a receiver which picks up signal from the transmitter, amplifies and retransmits it to the receiver.

6. Logic circuit of NAND gate:

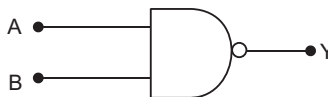

Truth table

Input		Output
A	B	Y
0	0	1
0	1	1
1	0	1
1	1	0

7. Mean life (τ) and half life ($T_{1/2}$) are related as:

$$\tau = \frac{T_{1/2}}{0.6931}$$

310 Xam idea Physics—XII

8. Uses of microwaves:

- (i) In long distance communications.
- (ii) In radar

9. $P = 3 \times 10^8 \text{ cm} ; E = 10^4 \text{ N/C}$

At stable equilibrium (θ_1) = 0

At unstable equilibrium (θ_2) = 180

Work done in rotating dipole is given by:

$$W = PE(\cos \theta_1 - \cos \theta_2)$$

$$= (3 \times 10^8)(10^4)[\cos 0 - \cos 180]$$

$$= 3 \times 10^4 [1 - (-1)]$$

$$W = 6 \times 10^8 \text{ J}$$

10. Variation of resistivity (ρ) with temperature (T) is shown below:

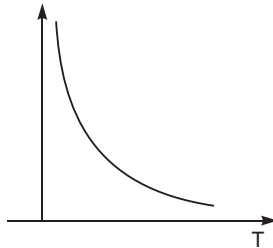

Explanation: In semiconductor the number density of free electrons (n) increases with increase in temperature (T) and consequently the relaxation period decreases. But the effect of increase in n has higher impact than decrease of τ . So, resistivity decreases with increase in temperature.

11. Energy released $m = 931 \text{ MeV}$

$$m = 4m({}_1^1\text{H}) - m({}_2^4\text{He})$$

$$\text{Energy released } (Q) = [4 \cdot m({}_1^1\text{H}) - m({}_2^4\text{He})] \cdot 931 \text{ MeV}$$

$$[4 \cdot 1.007825 - 4.002603] \cdot 931 \text{ MeV} = 26.72 \text{ MeV.}$$

12. $A_{\max} = 10\text{V}$

$$A_{\min} = 2 \text{ V}$$

$$\text{Modulation index} = \frac{A_{\max} - A_{\min}}{A_{\max} + A_{\min}} = \frac{10 - 2}{10 + 2} = \frac{8}{12} = 0.67$$

Generally, the modulation index is kept less than one to avoid distortion.

13. Block diagram of communication system:

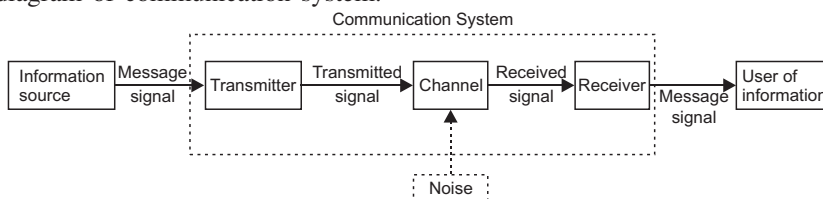

Function of a transducer is to convert one form of energy into another form.

14. (i) Magnetic lines of force form continuous closed loops because a magnet is always a dipole and as a result, the net magnetic flux of a magnet is always zero.
 (ii) When a diamagnetic substance is placed in an external magnetic field, a feeble magnetism is induced in opposite direction. So, magnetic lines of force are repelled.

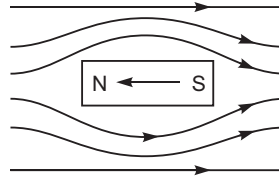

OR

- (i) Elements of earth's magnetic field:
 (a) Angle of declination () (b) Angle of dip ()
 (c) Horizontal component of earth's magnetic field (B_H)
 (ii) At equator.

15. Displacement current and generalised Ampere's Circuital Law: Consider a parallel plate capacitor, being charged by a battery. A time varying current is flowing through the capacitor. If we consider only the conduction current I , then we apply Ampere's Circuital Law to two closed loops C_1 and C_2 , then we get

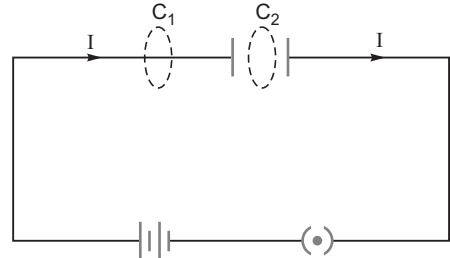

$$\oint_{C_1} \vec{B} \cdot d\vec{l} = \mu_0 I \quad \dots(i)$$

and $\oint_{C_2} \vec{B} \cdot d\vec{l} = 0 \quad \dots(ii)$

Since there cannot be any conduction current in region between the capacitor plates. As C_1 and C_2 are very close, we must expect

$$\oint_{C_1} \vec{B} \cdot d\vec{l} = \oint_{C_2} \vec{B} \cdot d\vec{l} \quad \dots(iii)$$

But this condition is violated by equations (i) and (ii). Hence Ampere's Circuital Law seems to be inconsistent in this case. Therefore, Maxwell postulated the existence of displacement current which is produced by time varying electric field. If $\sigma(t)$ is the surface charge density on capacitor plates and $q(t)$ is the charge, then time varying electric field $E(t) = \frac{\sigma(t)}{\epsilon_0} = \frac{q(t)}{A \epsilon_0}$, where A is area of each plate.

$$\frac{dE}{dt} = \frac{1}{A \epsilon_0} \frac{dq(t)}{dt} \quad \text{or} \quad \frac{dq(t)}{dt} = \epsilon_0 A \frac{dE}{dt}$$

This is expression for displacement current (I_d).
 Applying Kirchoff's first law at power P, we get $I = I_d$
 Hence, equation (i) and (ii) take the forms

$$\oint_{C_1} \vec{B} \cdot d\vec{l} = \mu_0 I \quad \text{and} \quad \oint_{C_2} \vec{B} \cdot d\vec{l} = \mu_0 I_d = \mu_0 I$$

The total current is the sum of the conduction current and displacement current. Thus, modified form of Ampere's circuital law is

$$\oint B \cdot dl = \mu_0 (I + I_d) = \mu_0 I + \mu_0 A \frac{dE}{dt}$$

But

$$EA = \text{Electric flux } \oint E \cdot dl$$

$$\oint B \cdot dl = \mu_0 \left(I + \epsilon_0 \frac{dE}{dt} \right)$$

16. Change in current (ΔI) = 5.0 A

Time taken (t) = 100 × 10⁻³ s

Induced emf (e) = 200 V

Induced emf (e) is given by

$$e = - \frac{d\phi}{dt}$$

$$= - \frac{d(LI)}{dt}$$

$$e = L \frac{dI}{dt}$$

or $L = e \cdot \frac{t}{\Delta I} = \frac{(200) \cdot (100 \times 10^{-3})}{(5.0)}$

$$L = 4.0 \text{ H}$$

17. (a) Resistance = 47 k ± 10% = 47 × 10³ ± 10%

Sequence of colour should be:

Yellow, Violet, Orange and Silver

(b) (i) Very low temperature coefficient of resistance.

(ii) High resistivity

18. Let A = area of each plate.

Let initially $C_1 = \epsilon_0 \frac{A}{d}$, $C_2 = \epsilon_0 \frac{A}{2d}$

After inserting respective dielectric slabs:

$$C_1 = KC \quad \dots(i)$$

and $C_2 = K_1 \frac{\epsilon_0 (A/2)}{d} = K_2 \frac{\epsilon_0 (A/2)}{d}$

$$= \frac{\epsilon_0 A}{2d} (K_1 + K_2)$$

$$C_2 = \frac{C}{2} (K_1 + K_2) \quad \dots(ii)$$

From (i) and (ii)

$$C_1 = KC$$

$$KC = \frac{C}{2} (K_1 + K_2)$$

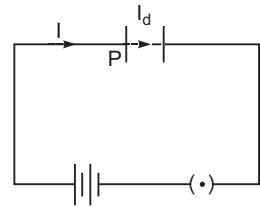

(L)

$$K \frac{1}{2}(K_1 K_2)$$

19. This device is Van de Graaff generator.

Principle: Suppose we have a large spherical conducting shell of radius R , carrying charge Q . The charge spreads uniformly over whole surface of the shell. Now suppose a small conducting sphere of radius ' r ' is introduced inside the spherical shell and placed at its centre, so that both the sphere and shell have same centre O . The electric field in the region inside the small sphere and large shell is due to charge q only, so electric field strength at a distance x from the centre O is

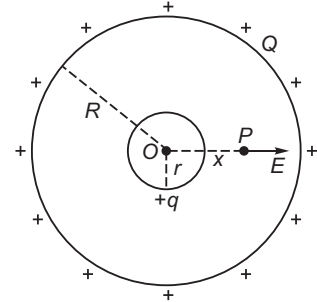

$$E = \frac{1}{4\pi\epsilon_0} \frac{q}{x^2}, \text{ directed radially outward}$$

The potential difference between the sphere and the shell

$$V(r) - U(R) = \int_R^r E \cdot dx$$

$$= \int_R^r \frac{1}{4\pi\epsilon_0} \frac{q}{x^2} dx = \frac{q}{4\pi\epsilon_0} \left[\frac{1}{r} - \frac{1}{R} \right]$$

This is independent of charge Q on the large spherical shell. As $r < R$; $V(r) - U(R)$ is positive. As charge flows from higher to lower potentials therefore, if we connect the small sphere and large shell by a conducting wire, the charge flows from sphere to outer shell whatsoever the charge on outer shell may be. This forms the principle of Van de Graaff generator. The maximum charge that may be given to outer shell which may cause discharge in air.

Working: When comb C_1 is given very high potential, then it produces ions in its vicinity, due to action of sharp points. The positive ions, so produced, get sprayed on the belt due to the repulsion between positive ions and comb C_1 . These positive ions are carried upward by the moving belt. The pointed end of C_2 just touches the belt. The comb C_2 collects positive charge from the belt which immediately moves to the outer surface of sphere S . As the belt goes on revolving, it continues to take () charge upward, which is collected by comb C_2 and transferred to outer surface of sphere S . Thus the outer surface of metallic sphere S gains positive charge continuously and its potential rises to a very high value.

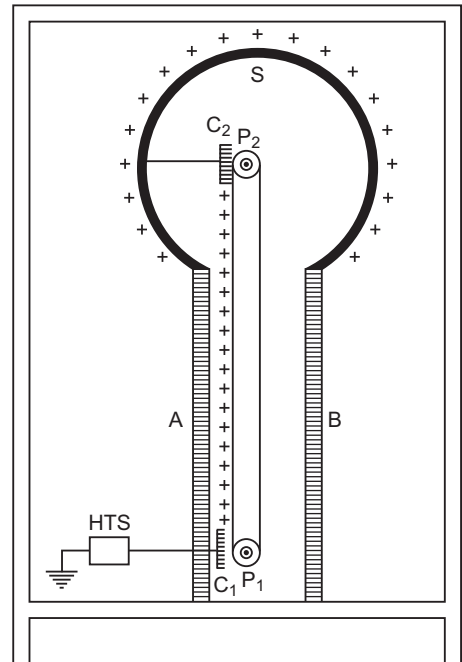

When the potential of a metallic sphere gains very high value, the dielectric strength of surrounding air breaks down and its charge begins to leak, to the surrounding air. The maximum potential is reached when the rate of leakage of charge becomes equal to the rate of charge transferred to the sphere. To prevent leakage of charge from the sphere, the generator is completely enclosed in an earthed connected steel tank which is filled with air under high pressure.

Van de Graaff generator is used to accelerate stream of charged particles to very high velocities. Such a generator is installed at IIT Kanpur which accelerates charged particles upto 2 MeV energy.

20. $2000 \text{ \AA} = 2000 \times 10^{-10} \text{ m}$

$W_0 = 4.2 \text{ eV}$

$h = 6.63 \times 10^{-34}$

$\frac{hc}{\lambda} = W_0 + KE$

or K.E. $= \frac{hc}{\lambda} - W_0$

$$\frac{(6.63 \times 10^{-34}) (3 \times 10^8)}{(2000 \times 10^{-10})} - \frac{1}{1.6 \times 10^{-19}} \text{ eV} = 4.2 \text{ eV}$$

$(6.2 \times 10^{-19}) \text{ eV} = 2.0 \text{ eV}$

(i) The energy of the emitted electrons does not depend upon intensity of incident light, hence the energy remains unchanged.

(ii) For this surface, electrons will not be emitted as the energy of incident light (6.2 eV) is less than the work function (4.2 eV) of the surface.

21. At the junction there is diffusion of charge carriers due to thermal agitation; so that some of electrons of *n*-region diffuse to *p*-region while some of holes of *p*-region diffuse into *n*-region. Some charge carriers combine with opposite charges to neutralise each other. Thus near the junction there is an excess of positively charged ions in *n*-region and an excess of negatively charged ions in *p*-region. This sets up a **potential difference** called potential barrier and hence an internal electric field E_i across the junctions.

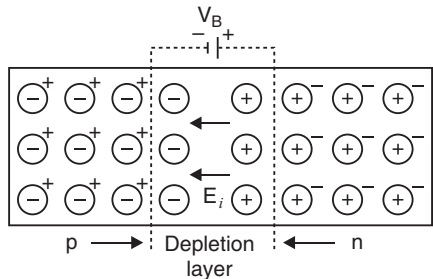

Barrier potential: During the formation of a *p-n* junction the electrons diffuse from *n* region to *p*-region and holes diffuse from *p*-region to *n*-region. This forms recombination of charge carriers. In this process immobile positive ions are collected at a junction toward *n* region and negative ions at a junction toward *p*-region. This causes a p.d. across the unbiased junction. This is called potential barrier or barrier potential.

22. Fringe width $(\Delta x) = \frac{D}{d}$

$y = \frac{D}{3} = \frac{D}{3d}$

$$\text{Path diff (} p) = \frac{yd}{D} = p = \frac{D}{3d} \frac{d}{D} = \frac{2}{3} \cdot p = \frac{2}{3} \cdot \frac{2}{3} = \frac{2}{3}$$

$$\text{Intensity at point } P = I_0 \cos^2$$

$$I_0 \cos^2 \frac{2}{3}$$

$$I_0 \left(\frac{1}{2}\right)^2$$

$$\frac{I_0}{4}$$

OR

- (i) In diffraction due to a single slit the path difference is given by:

$$x = a \sin \theta \quad \text{where, } a \text{ is the width of the slit}$$

$$\text{For maxima: } x = (2x - 1) \frac{a}{2}$$

$$x = a \sin \theta = (2x - 1) \frac{a}{2}$$

$$\text{For } n = 2, \quad x = \frac{3a}{2}$$

Let us divide the slit into three equal parts. If we take first two parts of slit, the path difference between rays diffracted from the extreme ends of first two parts

$$\frac{2}{3} a \sin \theta = \frac{2}{3} a = \frac{3}{2a}$$

Then the first two parts will have a path difference of $\frac{a}{2}$ and cancel the effect of each other.

The remaining third part will contribute to the intensity at a point between two minima. This is called first secondary maxima. In similar manner we can show that the intensity of the other secondary maxima will go on decreasing.

- (ii) The general maxima has between first minima on either side of the central maxima. We know for first minima.

$$a \sin \theta = a \quad \because \text{ for small angle } \sin \theta \sim \theta$$

$$\tan \theta = \frac{y_1}{D}$$

$$\frac{y_1}{D}$$

$$\frac{a}{D} = y_1 = y_2$$

Hence, whole width on secondary maxima on one side is $\frac{D}{a}$.

The angular width of the central maxima $\frac{2 D}{a}$.

So, angular width of the central maxima is twice that of the first order secondary maximum.

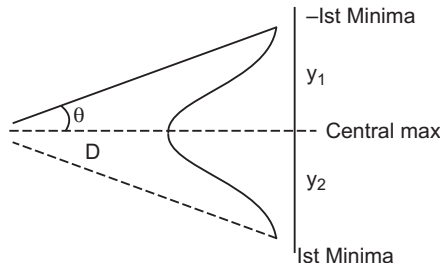

23. For first lens, $u_1 = 30 \text{ cm}, f_1 = 10 \text{ cm}$

From lens formula,

$$\frac{1}{f_1} = \frac{1}{v_1} - \frac{1}{u_1}$$

$$\frac{1}{10} = \frac{1}{v_1} - \frac{1}{30} \quad v_1 = 15 \text{ cm}$$

This means that the image formed by first lens is at a distance of 15 cm to the right of first lens. This image serves as a virtual object for second lens.

For second lens, $f_2 = 10 \text{ cm}, u_2 = 15 - 5 = 10 \text{ cm}$

$$\frac{1}{v_2} = \frac{1}{f_2} - \frac{1}{u_2} = \frac{1}{10} - \frac{1}{10} \quad v_2 = \infty$$

This means that the real image is formed by second lens at infinite distance. This acts as an object for third lens.

For third lens, $f_3 = 30 \text{ cm}, u_3 = \infty$

From lens formulae,

$$\frac{1}{v_3} = \frac{1}{f_3} - \frac{1}{u_3} = \frac{1}{30} - 0 \quad v_3 = 30 \text{ cm}$$

i.e., final image is formed at a distance 30 cm to the right of third lens. The ray diagram of formation of image is shown in figure.

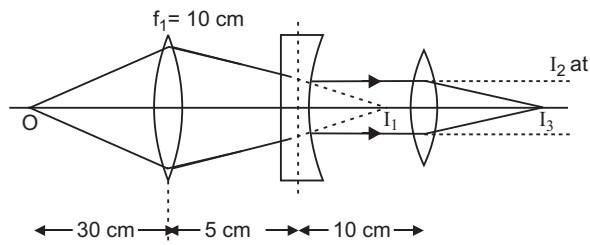

24.

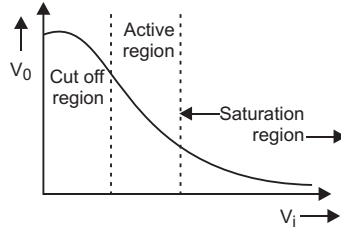

In active region the transistor is used as an amplifier.

- (i) **Input Resistance:** It is the ratio of change in emitter base voltage (V_{EB}) to the corresponding change in emitter current (I_E) at constant collector-base voltage (V_{CB}) i.e.

$$\text{Input resistance } r_i = \frac{V_{EB}}{I_E} \quad V_{CB} \text{ constant}$$

Physically input resistance is the hindrance offered to the signal current. The input resistance is very small, of the order of a few ohms, because a small change in V_{EB} causes a large change in I_E .

- (ii) **Output Resistance:** It is the ratio of change in collector-base voltage to the corresponding change in collector current at constant emitter current I_E

$$\text{i.e.,} \quad r_o = \frac{V_{CB}}{I_C} \quad I_E \text{ constant}$$

The output resistance is very high, of the order of several-tens kilo ohm because a large change in collector-base voltage causes a very small change in collector current.

- (iii) **Current amplification factors of a transistor (α and β):**

The current gain α is defined as the ratio of change in collector current to the change in emitter current for constant value of collector voltage in *common base configuration*, i.e.,

$$\alpha = \frac{I_C}{I_E} \quad V_C \text{ constant} \quad \dots(i)$$

Practical value of α ranges from 0.9 to 0.99 for junction transistor.

The current gain β is defined as the ratio of change in collector current to the change in base current for constant value of collector voltage in *common emitter configuration* i.e.,

$$\beta = \frac{I_C}{I_B} \quad V_C \text{ constant} \quad \dots(ii)$$

The value of β ranges from 20 to 200.

The current gains α and β are related as

$$\alpha = \frac{\beta}{1 + \beta} \quad \text{or} \quad \beta = \frac{\alpha}{1 - \alpha} \quad \dots(iii)$$

- 25. (i) At 90° , the intensity of emergent light is zero.

- (ii) Intensity of light coming out polariser P_1 is $\frac{I_0}{2}$

Intensity of light coming out from $P_3 = \frac{I_0}{2} \cos^2$

Intensity of light coming out from $P_2 = \frac{I_0}{2} \cos^2 + \cos^2(90^\circ)$

$$\frac{I_0}{2} \cos^2 + \sin^2$$

$$\frac{I_0}{2} \frac{(2 \cos + \sin)^2}{2}$$

$$I = \frac{I_0}{8} (\sin 2)^2$$

But it is given that intensity transmitted from P_2 is

$$I = \frac{I_0}{8}$$

So, $\frac{I_0}{8} = \frac{I_0}{8} (\sin 2)^2$

or, $(\sin 2)^2 = 1$

$$\sin 2 = \sin \frac{\pi}{2} = \frac{\pi}{4}$$

26. Suppose m be the mass of an electron and v be its speed in n th orbit of radius r . The centripetal force for revolution is produced by electrostatic attraction between electron and nucleus.

$$\frac{mv^2}{r} = \frac{1}{4\pi\epsilon_0} \frac{(Ze)(-e)}{r^2} \quad \dots (i)$$

or, $mv^2 = \frac{1}{4\pi\epsilon_0} \frac{Ze^2}{r}$

So, Kinetic energy $[K] = \frac{1}{2} mv^2$

$$K = \frac{1}{4\pi\epsilon_0} \frac{Ze^2}{2r}$$

Potential energy $= \frac{1}{4\pi\epsilon_0} \frac{(Ze)(-e)}{r}$

$$= -\frac{1}{4\pi\epsilon_0} \frac{Ze^2}{r}$$

Total energy, $E = K + PE$

$$= \frac{1}{4\pi\epsilon_0} \frac{Ze^2}{2r} - \frac{1}{4\pi\epsilon_0} \frac{Ze^2}{r}$$

$$E = -\frac{1}{4\pi\epsilon_0} \frac{Ze^2}{2r}$$

For n th orbit, E can be written as E_n

so,
$$E_n = \frac{1}{4} \frac{Z e^2}{0} \frac{1}{2 r_n}$$

Again from Bohr's postulate for quantization of angular momentum.

$$mvr = \frac{nh}{2}$$

$$v = \frac{nh}{2mr}$$

Substituting this value of v in equation (i), we get

$$\frac{m}{r} \frac{nh}{2mr} = \frac{1}{4} \frac{Ze^2}{0} \frac{1}{r^2}$$

or,
$$r = \frac{0 h^2 n^2}{m Z e^2}$$

or,
$$r_n = \frac{0 h^2 n^2}{m Z e^2} \quad \dots (ii)$$

Substituting value of r_n in equation (ii), we get

$$E_n = \frac{1}{4} \frac{Ze^2}{0} \frac{1}{2 \frac{0 h^2 n^2}{m Z e^2}} = \frac{m Z^2 e^4}{8 0 h^2 n^2}$$

or,
$$E_n = \frac{Z^2 R h c}{n^2}, \quad \text{where } R = \frac{m e^4}{8 0 c h^3}$$

R is called Rydberg constant.

For hydrogen atom $Z = 1$,

$$E_n = \frac{R h c}{n^2}$$

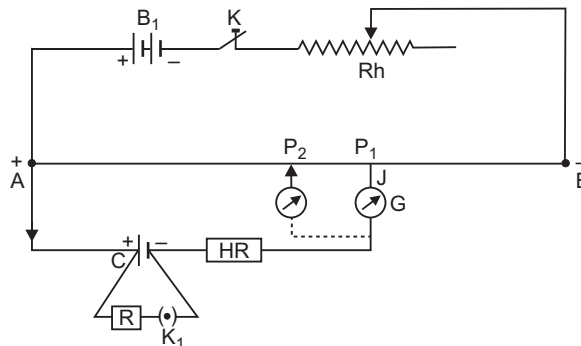

If n_i and n_f are the quantum numbers of initial and final states and E_i & E_f are energies of electron in H-atom in initial and final state, we have

$$E_i = \frac{Rhc}{n_i^2} \quad \text{and} \quad E_f = \frac{Rhc}{n_f^2}$$

If ν is the frequency of emitted radiation, we get

$$\frac{E_i - E_f}{h} = \frac{Rc}{n_i^2} - \frac{Rc}{n_f^2}$$

$$Rc \left(\frac{1}{n_f^2} - \frac{1}{n_i^2} \right)$$

- 27. Principle of potentiometer:** If constant current is flowing through a wire of uniform area of cross-section at constant temperature, the potential drop across any portion of wire is directly proportional to the length of that portion

$$V \propto l$$

Determination of internal resistance of potentiometer.

(i) Initially key K is closed and a potential difference is applied across the wire AB . Now rheostat (Rh) is so adjusted that on touching the jockey J at ends A and B of potentiometer wire, the deflection in the galvanometer is on both sides. Suppose that in this position the potential gradient on the wire is k .

(ii) Now key K_1 is kept open and the position of null deflection is obtained by sliding and pressing the jockey on the wire. Let this position be P_1 and $AP_1 = l_1$. In this situation the cell is in open circuit, therefore the terminal potential difference will be equal to the emf of cell, i.e.,

$$\text{emf} = kl_1 \quad \dots(i)$$

(iii) Now a suitable resistance R is taken in the resistance box and key K_1 is closed. Again, the position of null point is obtained on the wire by using jockey J . Let this position on wire be P_2 and $AP_2 = l_2$.

In this situation the cell is in closed circuit, therefore the terminal potential difference (V) of cell will be equal to the potential difference across external resistance R , i.e.,

$$V = kl_2 \quad \dots(ii)$$

Dividing (i) by (ii), we get $\frac{\text{emf}}{V} = \frac{l_1}{l_2}$

$$\text{Internal resistance of cell, } r = \frac{1}{V} \left(1 - R \right) \frac{l_1}{l_2} \left(1 + R \right)$$

From this formula r may be calculated.

- 28. (a)** Torque (τ) on the loop is given by:

$$\tau = NIAB \sin \theta$$

which can be written as,

$$M = B$$

where, M is the magnetic dipole moment given by

$$M = N I A$$

(b) **Torque on a current carrying loop:**

Consider a rectangular loop $PQRS$ of length l , breadth b suspended in a uniform magnetic field \mathbf{B} . The length of loop PQ RS l and breadth QR SP b . Let at any instant the normal to the plane of loop make an angle

with the direction of magnetic field \mathbf{B} and I be the current in the loop. We know that a force acts on a current carrying wire placed in a magnetic field. Therefore, each side of the loop will experience a force. The net force and torque acting on the loop will be determined by the forces acting on all sides of the loop. Suppose that the forces on sides PQ , QR , RS

and SP are \mathbf{F}_1 , \mathbf{F}_2 , \mathbf{F}_3 and \mathbf{F}_4 respectively. The sides QR and SP make angle (90°) with the direction of magnetic field. Therefore each of the forces \mathbf{F}_2 and \mathbf{F}_4 acting on these sides has same magnitude $F = B l b \sin(90^\circ) = B l b \cos$. According

to Fleming's left hand rule the forces \mathbf{F}_2 and \mathbf{F}_4 are equal and opposite but their line of action is same. Therefore these forces cancel each other *i.e.* the resultant of \mathbf{F}_2 and \mathbf{F}_4 is zero. The sides PQ and RS of current loop are perpendicular to the magnetic field, therefore the magnitude of each of forces \mathbf{F}_1 and \mathbf{F}_3 is

$F = I l B \sin 90^\circ = I l B$.

According to Fleming's left hand rule the forces \mathbf{F}_1 and \mathbf{F}_3 acting on sides PQ and RS are equal and opposite, but their lines of action are different; therefore the resultant force of \mathbf{F}_1 and \mathbf{F}_3 is zero, but they form a couple called the **deflecting couple**. When the normal to plane of loop makes an angle with the direction of magnetic field B , the perpendicular distance between F_1 and F_3 is $b \sin$.

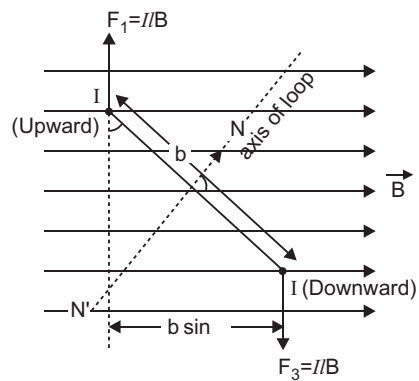
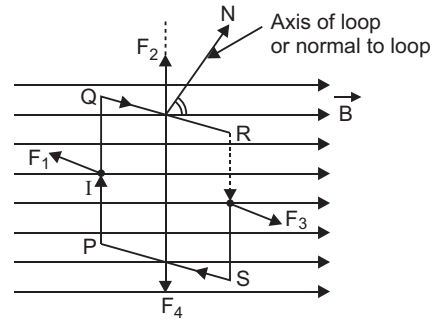

Moment of couple or Torque,
 (Magnitude of one force F) perpendicular distance (BIl) $(b \sin \theta)$ $I(lb) B \sin \theta$
 But lb area of loop A (say)
 Torque, $IAB \sin \theta$
 If the loop contains N -turns, then $NIAB \sin \theta$

In vector form $\vec{\tau} = NI \vec{A} \times \vec{B}$.

Direction of torque is perpendicular to direction of area of loop as well as the direction of magnetic field *i.e.*, along $\vec{I} \times \vec{A} \times \vec{B}$.

(c) $G = 50$

$$I_g = 5 \text{ mA} = 5 \times 10^{-3} \text{ A}$$

$$V = 15 \text{ V}$$

The galvanometer can be converted into a voltmeter when a high resistance R is connected in series with it.

Value of R is given by:

$$R = \frac{V}{I_g} - G = \frac{15}{5 \times 10^{-3}} - 50$$

$$= \frac{3000}{5} - 50$$

$$= 600 - 50 = 550 \text{ } \Omega = 0.55 \text{ k} \Omega$$

OR

(a) **Principle:** The positive ions produced from a source are accelerated. Due to the presence of perpendicular magnetic field the ion will move in a circular path. The phenomenon is continued till the ion reaches at the periphery where an auxiliary negative electrode (deflecting plate) deflects the accelerated ion on the target to be bombarded.

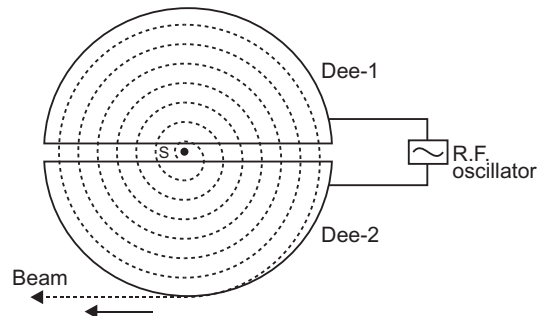

Expression for K.E. attained:

If R be the radius of the path and v_{\max} the velocity of the ion when it leaves the periphery, then

$$v_{\max} = \frac{qBR}{m}$$

The kinetic energy of the ion when it leaves the apparatus is,

$$K.E. = \frac{1}{2} m v_{\max}^2 = \frac{q^2 B^2 R^2}{2m}$$

When charged particle crosses the gap between dees it gains KE qV

In one revolution, it crosses the gap twice, therefore if it completes n -revolutions before emerging the dees, the kinetic energy gained

Thus
$$\text{K.E.} = \frac{2nqV}{2m} = 2nqV$$

(b) $I_1 = 2 \text{ A}, I_2 = 5 \text{ A}, a = 1 \text{ cm} = 1 \times 10^{-2} \text{ m}$

Force between two parallel wires per unit length is given by

$$F = \frac{\mu_0}{2} \frac{I_1 I_2}{a}$$

$$= 2 \times 10^{-7} \frac{2 \times 5}{1 \times 10^{-2}} = 20 \times 10^{-5} \text{ N (Repulsive)}$$

29. (a) Suppose there are two coils C_1 and C_2 . The current I_1 is flowing in primary coil C_1 ; due to which an effective magnetic flux ϕ_2 is linked with secondary coil C_2 . By experiments

$$\phi_2 = I_1 \text{ or } \phi_2 = MI_1 \quad \dots(i)$$

where M is a constant, and is called the *coefficient of mutual induction or mutual inductance*. From (i)

$$M = \frac{\phi_2}{I_1}$$

If $I_1 = 1$ ampere, $M = \phi_2$

i.e., the mutual inductance between two coils is numerically equal to the effective flux linkage with secondary coil, when current flowing in primary coil is 1 ampere.

Mutual Inductance of Two Co-axial Solenoids:

Consider two long co-axial solenoid each of length l with number of turns N_1 and N_2 wound one over the other. Number of turns per unit length in order (primary) solenoid, $n = \frac{N_1}{l}$. If I_1 is the

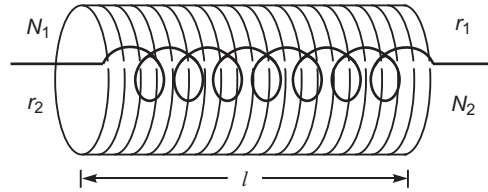

current flowing in primary solenoid, the magnetic field produced within this solenoid.

$$B_1 = \frac{\mu_0 N_1 I_1}{l} \quad \dots(ii)$$

The flux linked with each turn of inner solenoid coil is $\phi_2 = B_1 A_2$, where A_2 is the cross-sectional area of inner solenoid. The total flux linkage with inner coil of N_2 -turns.

$$\phi_2 = N_2 \phi_2 = N_2 B_1 A_2 = N_2 \frac{\mu_0 N_1 I_1}{l} A_2 = \frac{\mu_0 N_1 N_2}{l} A_2 I_1$$

By definition **Mutual Inductance, $M_{21} = \frac{\phi_2}{I_1} = \frac{\mu_0 N_1 N_2 A_2}{l}$**

If n_1 is number of turns per unit length of outer solenoid and r_2 is radius of inner solenoid, then $M = \mu_0 n_1 N_2 r_2^2$.

- (b) Due to current I_1 through solenoid of radius r_1 , flux linked with second solenoid

$$\phi_2 = M_{21} I_1 \quad \dots(i)$$

But flux due to current I_1 in first solenoid (using Ampere's circuital law) will be $\frac{\mu_0 N_1 I_1}{l}$.

Hence $N_2 \phi = N_2 \left(\frac{\mu_0 N_1 I_1}{l} \right) \times \pi r_2^2$ as $l = r_2$ and $r_2 = r_1$

Using (1)

$$M_{21} = \frac{\mu_0 N_1 N_2}{l} \pi r_1^2$$

which is same as expression of mutual inductance derived in part (a) above.

(c) $V_p = 2200V, I_0 = 5A, N_p = 4000$
 $V_s = 220V, N_s = ?, I_s = ?$

$$\frac{V_s}{V_p} = \frac{I_p}{I_s} \frac{N_s}{N_p}$$

$$\frac{220}{2200} = \frac{5}{I_s} \frac{N_s}{4000}$$

$$\frac{22}{2200} = \frac{5}{I_s} \frac{N_s}{4000}$$

$$\frac{1}{100} = \frac{5}{I_s} \frac{N_s}{4000}$$

$$I_s = 50A$$

$$\frac{5}{I_s} = \frac{N_s}{4000}$$

$$\frac{5}{50} = \frac{N_s}{4000}$$

$$N_s = 400$$

OR

(a) $V = V_m \sin \omega t$

$i = i_m \sin(\omega t - \phi)$

and instantaneous power, $P = Vi$

$$V_m \sin \omega t \cdot i_m \sin(\omega t - \phi) = V_m i_m \sin \omega t \sin(\omega t - \phi)$$

$$= \frac{1}{2} V_m i_m [2 \sin \omega t \cdot \sin(\omega t - \phi)]$$

From trigonometric formula

$$2 \sin A \sin B = \cos(A - B) - \cos(A + B)$$

Instantaneous power, $P = \frac{1}{2} V_m i_m [\cos(\omega t - \phi) - \cos(\omega t + \phi)]$

$$= \frac{1}{2} V_m i_m [\cos \phi - \cos(2\omega t - \phi)] \quad \dots (i)$$

Average power for complete cycle

$$P = \frac{1}{2} V_m i_m [\cos \overline{\cos(2t)}]$$

where $\overline{\cos(2t)}$ is the mean value of $\cos(2t)$ over complete cycle. But for a complete cycle, $\overline{\cos(2t)} = 0$

Average power,

$$P = \frac{1}{2} V_m i_m \cos$$

$$\frac{V_0}{\sqrt{2}} \frac{i_0}{\sqrt{2}} \cos$$

$$P = V_{rms} i_{rms} \cos$$

(b) The power is $P = V_{rms} I_{rms} \cos$. If \cos is small, then current considerably increases when voltage is constant. Power loss, we know is $I^2 R$. Hence, power loss increases.

(c) I_v ?, Q ?

$$L = 1.00 \text{ mH} = 1 \times 10^{-3} \text{ H}, C = 1.00 \text{ nF} = 1 \times 10^{-9} \text{ F}$$

$$R = 100 \Omega, E_0 = 100 \text{ V}$$

$$I_0 = \frac{E_0}{\sqrt{R^2 + \left(L - \frac{1}{C}\right)^2}} = \frac{E_0}{Z}$$

at resonance $L = \frac{1}{C}$

Hence $Z = R$

$$I = \frac{V}{R} = \frac{100}{100}$$

$$I_0 = 1 \text{ A}$$

$$I_v = \frac{I_0}{\sqrt{2}} = \frac{1}{\sqrt{2}} = \frac{\sqrt{2}}{2} = \frac{1.414}{2} = 0.707 \text{ A}$$

$$I_v = 0.707 \text{ A}$$

$$Q = \frac{1}{R} \sqrt{\frac{L}{C}} = \frac{1}{100} \sqrt{\frac{1.0 \times 10^{-3}}{1.0 \times 10^{-9}}} = \frac{1}{100} \times 10^3 = 10$$

$$Q = 10$$

30. (i) When a wave starting from one homogeneous medium enters the another homogeneous medium, it is deviated from its path. This phenomenon is called **refraction**. In transversing from first medium to another medium, the frequency of wave remains unchanged but its speed and the wavelength both are changed. Let XY be a surface separating the two media '1' and '2'. Let v_1 and v_2 be the speeds of waves in these media.

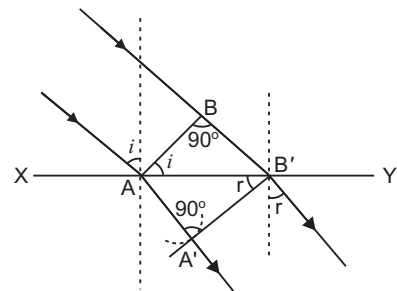

Suppose a plane wavefront AB in first medium is incident obliquely on the boundary surface XY and its end A touches the surface at A at time $t = 0$ while the other end B reaches the surface at point B' after time-interval t . Clearly $BB' = v_1 t$. As the wavefront AB advances, it strikes the points between A and B' of boundary surface. According to Huygen's principle, secondary spherical wavelets originate from these points, which travel with speed v_1 in the first medium and speed v_2 in the second medium.

First of all secondary wavelet starts from A , which traverses a distance $AA' = v_2 t$ in second medium in time t . In the same time-interval t , the point of wavefront traverses a distance $BB' = v_1 t$ in first medium and reaches B' , from, where the secondary wavelet now starts. Clearly $BB' = v_1 t$ and $AA' = v_2 t$.

Assuming A as centre, we draw a spherical arc of radius $AA' = v_2 t$ and draw tangent $A'B'$ on this arc from B' . As the incident wavefront AB advances, the secondary wavelets start from points between A and B' , one after the other and will touch $A'B'$ simultaneously. According to Huygen's principle $A'B'$ is the new position of wavefront AB in the second medium. Hence $A'B'$ will be the refracted wavefront.

- (ii) **Proof of Snell's law of Refraction using Huygen's wave theory:** When a wave starting from one homogeneous

First law: As AB , $A'B'$ and surface XY are in the plane of paper, therefore the perpendicular drawn on them will be in the same plane. As the lines drawn normal to wavefront denote the rays, therefore we may say that the incident ray, refracted ray and the normal at the point of incidence all lie in the same plane.

This is the first law of refraction.

Second law: Let the incident wavefront AB and refracted wavefront $A'B'$ make angles i and r respectively with refracting surface XY .

In right-angled triangle ABB' , $\angle ABB' = 90^\circ$

$$\sin i = \sin \angle BAB' = \frac{BB'}{AB} = \frac{v_1 t}{AB} \quad \dots(i)$$

Similarly in right-angled triangle $AA'B'$, $\angle AA'B' = 90^\circ$

$$\sin r = \sin \angle A'B'A = \frac{AA'}{A'B'} = \frac{v_2 t}{A'B'} \quad \dots(ii)$$

Dividing equation (i) by (ii), we get

$$\frac{\sin i}{\sin r} = \frac{v_1}{v_2} = \text{constant} \quad \dots(iii)$$

As the rays are always normal to the wavefront, therefore the incident and refracted rays make angles i and r with the normal drawn on the surface XY i.e. i and r are the angle of incidence and angle of refraction respectively. According to equation (3):

The ratio of sine of angle of incidence and the sine of angle of refraction is a constant and is equal to the ratio of velocities of waves in the two media. This is the second law of refraction, and is called the Snell's law.

- (iii) No. Because energy of wave depends on its frequency and not on its speed.

OR

(i) Let PQR be the principal section of the prism. The refracting angle of the prism is A .

A ray of monochromatic light EF is incident on face PQ at angle of incidence i_1 . The refractive index of material of prism for this ray is n . This ray enters from rarer to denser medium and so is deviated towards the normal FN and gets refracted along the direction FG . The angle of refraction for this face is r_1 . The refracted ray FG becomes incident on face PR and is refracted away from the normal GN_2 and emerges in the direction GH . The angle of incidence on this face is r_2 (into prism) and angle of refraction (into air) is i_2 . The incident ray EF and emergent ray GH when produced meet at O . The angle between these two rays is called angle of deviation ‘ δ ’.

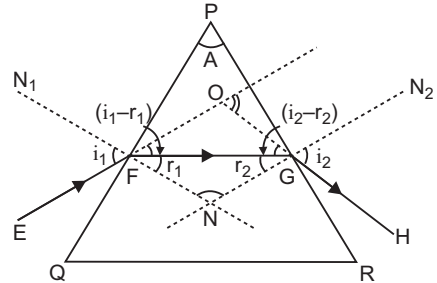

$$\angle OFG = i_1 - r_1 \quad \text{and} \quad \angle OGF = i_2 - r_2$$

In $\triangle FOG$, $\angle FOG$ is exterior angle

$$\angle FOG = \angle OFG + \angle OGF = (i_1 - r_1) + (i_2 - r_2) \quad \dots(i)$$

The normals FN_1 and GN_2 on faces PQ and PR respectively, when produced meet at N . Let $\angle FNG = A$

$$\text{In } \triangle FGN, \quad r_1 + r_2 + A = 180 \quad \dots(ii)$$

$$\text{In quadrilateral } PFNG, \quad \angle PFN = 90^\circ, \quad \angle PGN = 90^\circ \\ \angle A = 90^\circ + 90^\circ - 360^\circ \quad \text{or} \quad \angle A = 180^\circ - (r_1 + r_2) \quad \dots(iii)$$

$$\text{Comparing (ii) and (iii),} \quad r_1 + r_2 = A \quad \dots(iv)$$

Substituting this value in (i), we get

$$\angle FOG = i_1 + i_2 - A \quad \dots(v)$$

$$\text{or} \quad \angle FOG = i_1 + i_2 - A \quad \dots(vi)$$

$$\text{From Snell's law} \quad n = \frac{\sin i_1}{\sin r_1} = \frac{\sin i_2}{\sin r_2} \quad \dots(vii)$$

For minimum deviation i_1 and i_2 become coincident, i.e., $i_1 = i_2 = i$ (say)

$$\text{So from (vii)} \quad r_1 = r_2 = r \text{ (say)}$$

Hence from (iv) and (vi), we get

$$r + r = A \quad \text{or} \quad r = A/2$$

$$\text{and} \quad i = i = A + \delta \quad \text{or} \quad i = \frac{A + \delta}{2}$$

$$\text{Hence from Snell's law,} \quad n = \frac{\sin i}{\sin r} = \frac{\sin \frac{A + \delta}{2}}{\sin \frac{A}{2}}$$

(ii)

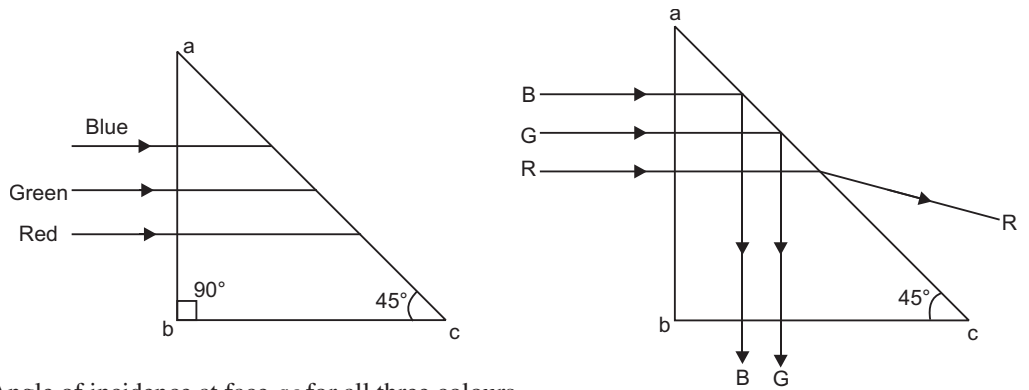

Angle of incidence at face ac for all three colours,

$$i = 45^\circ$$

Refractive index corresponding to critical angle 45° is

$$\frac{1}{\sin 45^\circ} = \sqrt{2} = 1.414$$

The ray will be transmitted through face ' ac ' if $i < i_c$. This condition is satisfied for red colour ($n = 1.39$). So only red ray will be transmitted, Blue and Green rays will be totally reflected.

CBSE (Foreign) SET-II

1. Peak value (i_0) 12 A

$$(i) i_{rms} = \frac{i_0}{\sqrt{2}} = \frac{12}{\sqrt{2}} = \frac{12}{\sqrt{2}} \cdot \frac{\sqrt{2}}{\sqrt{2}} = 6\sqrt{2} \text{ A}$$

$$(ii) i_{av} = 0 \text{ A}$$

2.

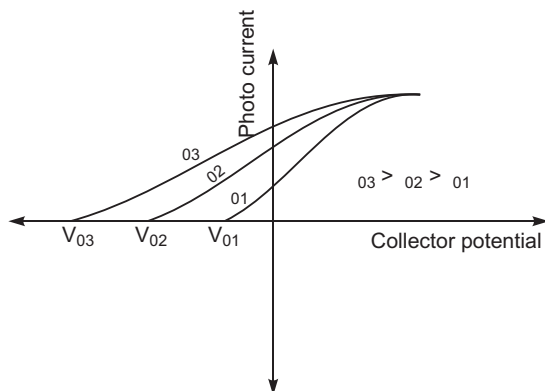

3. The charge on both spheres would be $\frac{q_A + q_B}{2}$.

4. The function of transmitter is to convert the message signal produced by the source of information into a form suitable for transmission through the channel.

5. (i) Doctors use infrared lamps to treat skin diseases and relieve the pain of sore muscles
 (ii) In electronic devices for example semiconductor light emitting diodes.
7. Logic circuit of AND gate:

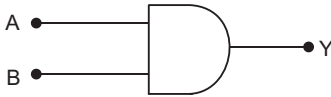

Truth Table

Inputs		Output
A	B	Y
0	0	0
0	1	0
1	0	0
1	1	1

10. Dipole moment $P = 5 \times 10^{-4}$ Cm.

Electric field (E) 10^4 N/C

At stable equilibrium $\theta_1 = 0$

At unstable equilibrium $\theta_2 = 180$

$$\begin{aligned} \text{Work done} &= PE(\cos \theta_2 - \cos \theta_1) \\ &= (5 \times 10^{-8})(10^4)(\cos 180 - \cos 0) \\ &= 10 \times 10^{-4} \text{ J} \end{aligned}$$

12. $A_{\max} = 12$ V

$A_{\min} = 2$ V

$$\begin{aligned} \text{Modulation index} &= \frac{A_{\max} - A_{\min}}{A_{\max} + A_{\min}} \\ &= \frac{12 - 2}{12 + 2} = \frac{10}{14} = 0.714 \end{aligned}$$

To minimize distortion of signal due to noise signal from atmosphere and electrical disturbances modulation index is kept less than one.

13. $C_1 = \frac{Q}{d}$

$$\frac{1}{C_2} = \frac{1}{K_1 \frac{Q}{d/2}} + \frac{1}{K_2 \frac{Q}{d/2}} = \frac{d}{2 K_1 Q} + \frac{d}{2 K_2 Q}$$

$$\frac{1}{C_2} = \frac{d}{2 Q} \left(\frac{1}{K_1} + \frac{1}{K_2} \right) \quad C_2 = \frac{2 Q}{d} \frac{K_1 K_2}{K_1 + K_2}$$

$$C_2 = 2C_1 \frac{K_1 K_2}{K_1 + K_2}$$

$$C_2 = C_1 \frac{2 K_1 K_2}{K_1 + K_2}$$

330 Xam idea Physics—XII

15. Change in current (I) $(0.02 - 0) \text{ A} = -0.02 \text{ A}$

Time taken (t) $10 \text{ ms} = 10 \times 10^{-3} \text{ s}$

From law of induction

Induced emf is given by:

$$e = - \frac{d\Phi}{dt} = - \frac{L dI}{dt}$$

$$e = L \frac{dI}{dt}$$

$$L = \frac{e t}{dI} = \frac{(200)(10 \times 10^{-3})}{(0.02)}$$

$$L = 1000 \text{ H}$$

27. Wavelength of incident radiation (λ) 2500 \AA

Work function (W_0) 3.5 eV

$$\frac{hc}{\lambda} = W_0 + KE_{\max}$$

$$KE_{\max} = \frac{hc}{\lambda} - W_0$$

$$= \frac{(6.63 \times 10^{-34})(3 \times 10^8)}{2500 \times 10^{-10}} - \frac{1}{1.6 \times 10^{19}} \times 3.5 \text{ eV}$$

$$= (4.97 - 3.5) \text{ eV} = 1.47 \text{ eV}$$

(i) KE of fastest electron 1.47 eV

(ii) KE of slowest electron $= 0 \text{ eV}$

If the same light (having energy 4.97 eV) falls on the surface (of work function 5.5 eV), then no photoelectrons will emit.

CBSE (Foreign) SET-III

2.

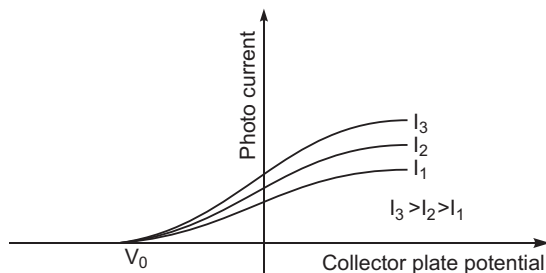

3. Change on each $\frac{q_A}{2}$ $\frac{3q_A}{2}$ q_A

4. Peak value of current (i_0) = 15 A

$$(i) i_{rms} = \frac{i_0}{\sqrt{2}} = \frac{15}{\sqrt{2}} = \frac{15}{\sqrt{2}} \cdot \frac{\sqrt{2}}{\sqrt{2}} = 7.5\sqrt{2} \text{ A}$$

$$(ii) i_{av} = 0$$

6. Logic circuit of NOT gate

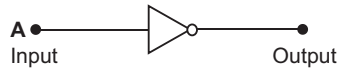

Truth Table

Input A	Output Y
0	1
1	0

7. The function of receiver is to receive the modulated wave and it demodulates, amplifies and reproduces the original message signal from it.
8. (i) In the detection of fracture, deformity of the bones/skeletal system.
(ii) In study of crystal structure.
9. Dipole moment (P) = 2×10^8 Cm

$$\text{Electric field (E)} = 5 \times 10^4 \text{ N/C}$$

$$\theta_1 = 0^\circ, \theta_2 = 180^\circ$$

$$\begin{aligned} \text{Work done} &= PE (\cos \theta_1 - \cos \theta_2) \\ &= (2 \times 10^8)(5 \times 10^4) [\cos 0^\circ - \cos 180^\circ] \\ &= (10 \times 10^{12}) [1 - (-1)] \\ &= 20 \times 10^{12} \text{ J.} \end{aligned}$$

12. $C_1 = \frac{Q}{d}$

$$C_2 = \frac{K_1 Q}{d} + \frac{K_2 Q}{d}$$

$$= \frac{Q}{2d} [K_1 + K_2]$$

$$C_2 = C_1 \frac{[K_1 + K_2]}{2}$$

14. Charge in current (Q) = $(0.03 \text{ C}) = 3 \times 10^{-2} \text{ C}$

$$\text{Time taken (t)} = 300 \text{ ms} = 300 \times 10^{-3} \text{ s}$$

$$\text{Induced emf (e)} = \frac{Q}{t} = \frac{(LI)}{t}$$

$$e = L \frac{I}{t}$$

$$L = e \cdot \frac{t}{I}$$

$$L = \frac{[200][300 \cdot 10^{-3}]}{[3 \cdot 0]}$$

$$L = 20.0 \text{ H}$$

15. $A_{\max} = 15 \text{ V}, A_{\min} = 3 \text{ V}$

$$\text{Modulation index } (m) = \frac{A_{\max} - A_{\min}}{A_{\max} + A_{\min}}$$

$$= \frac{15 - 3}{15 + 3} = \frac{12}{18} = 0.67$$

The modulation index is kept low to reduce distortion.

26. $\lambda = 2400 \text{ \AA} = 2400 \cdot 10^{-10} \text{ m}$, work function (W_0) = 3.6 eV

$$\text{K.E.} = \frac{hc}{\lambda} - W_0$$

$$= \frac{(6.63 \cdot 10^{-34})(3 \cdot 10^8)}{2400 \cdot 10^{-10}} - \frac{1}{1.6 \cdot 10^{19}} \cdot 3.6 \text{ eV}$$

$$= (5.18 - 3.6) \text{ eV}$$

$$= 1.58 \text{ eV}$$

(i) K.E. of fastest electron = 1.58 eV

(ii) K.E. of slowest electron = 0 eV

If the same light (having energy 5.18 eV) falls on the surface of work function 5.5 eV, then no photoelectron will emit.

CBSE EXAMINATION PAPERS

DELHI-2012

Time allowed: 3 hours

Maximum marks: 70

General Instructions: As given in CBSE Examination Papers Delhi-2011.

CBSE (Delhi) Set-I

1. When electrons drift in a metal from lower to higher potential, does it mean that all the free electrons of the metal are moving in the same direction?
2. The horizontal component of the earth's magnetic field at a place is B and angle of dip is 60° . What is the value of vertical component of earth's magnetic field at equator?
3. Show on a graph, the variation of resistivity with temperature for a typical semiconductor.
4. Why should electrostatic field be zero inside a conductor?
5. Name the physical quantity which remains same for microwaves of wavelength 1 mm and UV radiations of 1600 \AA in vacuum.
6. Under what condition does a biconvex lens of glass having a certain refractive index act as a plane glass sheet when immersed in a liquid?
7. Predict the directions of induced currents in metal rings 1 and 2 lying in the same plane where current I in the wire is increasing steadily.



8. State de-Broglie hypothesis.
9. A ray of light, incident on an equilateral glass prism ($n_g = \sqrt{3}$) moves parallel to the base line of the prism inside it. Find the angle of incidence for this ray.
10. Distinguish between 'Analog and Digital signals'.

OR

Mention the function of any two of the following used in communication system:

- (i) Transducer
 - (ii) Repeater
 - (iii) Transmitter
 - (iv) Bandpass Filter
11. A cell of emf E and internal resistance r is connected to two external resistances R_1 and R_2 and a perfect ammeter. The current in the circuit is measured in four different situations:
- (i) without any external resistance in the circuit.
 - (ii) with resistance R_1 only
 - (iii) with R_1 and R_2 in series combination
 - (iv) with R_1 and R_2 in parallel combination.

The currents measured in the four cases are 0.42 A, 1.05 A, 1.4 A and 4.2 A, but not necessarily in that order. Identify the currents corresponding to the four cases mentioned above.

12. The susceptibility of a magnetic material is -2.6×10^{-5} . Identify the type of magnetic material and state its two properties.
13. Two identical circular wires P and Q each of radius R and carrying current 'I' are kept in perpendicular planes such that they have a common centre as shown in the figure. Find the magnitude and direction of the net magnetic field at the common centre of the two coils.

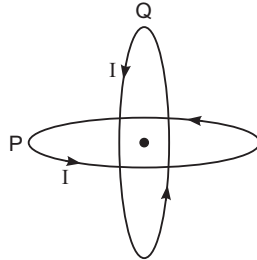

14. When an ideal capacitor is charged by a dc battery, no current flows. However, when an ac source is used, the current flows continuously. How does one explain this, based on the concept of displacement current?
15. Draw a plot showing the variation of (i) electric field (E) and (ii) electric potential (V) with distance r due to a point charge Q .
16. Define self-inductance of a coil. Show that magnetic energy required to build up the current I in a coil of self inductance L is given by $\frac{1}{2} LI^2$.
17. The current in the forward bias is known to be more (\sim mA) than the current in the reverse bias (\sim A). What is the reason, then, to operate the photodiode in reverse bias?
18. A metallic rod of 'L' length is rotated with angular frequency of ' ω ' with one end hinged at the centre and the other end at the circumference of a circular metallic ring of radius L , about an axis passing through the centre and perpendicular to the plane of the ring. A constant and uniform magnetic field B parallel to the axis is present everywhere. Deduce the expression for the emf between the centre and the metallic ring.
19. The figure shows a series LCR circuit with $L = 5.0$ H, $C = 80$ F, $R = 40$ connected to a variable frequency 240V source. Calculate.

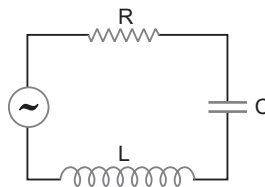

- (i) The angular frequency of the source which drives the circuit at resonance.
- (ii) The current at the resonating frequency.
- (iii) The rms potential drop across the capacitor at resonance.

20. A rectangular loop of wire of size $4\text{ cm} \times 10\text{ cm}$ carries a steady current of 2 A . A straight long wire carrying 5 A current is kept near the loop as shown. If the loop and the wire are coplanar, find
- the torque acting on the loop and
 - the magnitude and direction of the force on the loop due to the current carrying wire.

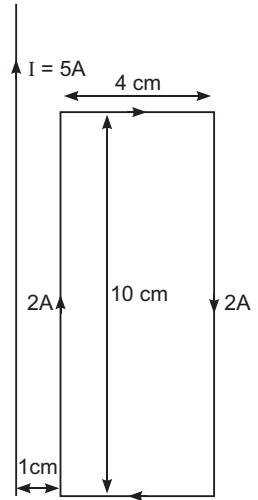

21. (a) Using Bohr's second postulate of quantization of orbital angular momentum show that the circumference of the electron in the n^{th} orbital state in hydrogen atom is n times the de Broglie wavelength associated with it.
- (b) The electron in hydrogen atom is initially in the third excited state. What is the maximum number of spectral lines which can be emitted when it finally moves to the ground state?
22. In the figure a long uniform potentiometer wire AB is having a constant potential gradient along its length. The null points for the two primary cells of emfs ϵ_1 and ϵ_2 connected in the manner shown are obtained at a distance of 120 cm and 300 cm from the end A . Find (i) ϵ_1 / ϵ_2 and (ii) position of null point for the cell ϵ_1 .
- How is the sensitivity of a potentiometer increased?

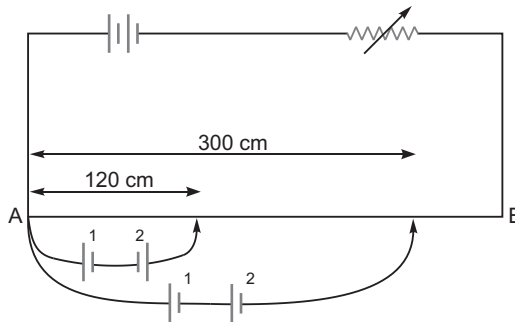

OR

Using Kirchoff's rules determine the value of unknown resistance R in the circuit so that no current flows through $4\ \Omega$ resistance. Also find the potential difference between A and D .

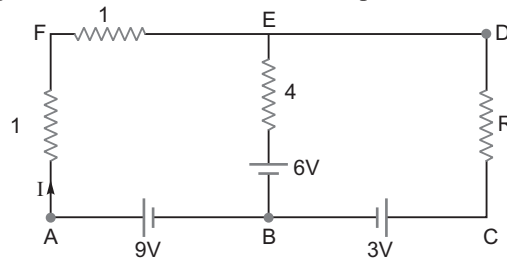

23. (i) What characteristic property of nuclear force explains the constancy of binding energy per nucleon (BE/A) in the range of mass number 'A' lying $30 < A < 170$?
(ii) Show that the density of nucleus over a wide range of nuclei is constant independent of mass number A .
24. Write any two factor which justify the need for modulating a signal.
Draw a diagram showing an amplitude modulated wave by superposing a modulating signal over a sinusoidal carrier wave.
25. Write Einstein's photoelectric equation. State clearly how this equation is obtained using the photon picture of electromagnetic radiation.
Write the three salient features observed in photoelectric effect which can be explained using this equation.
26. (a) Why are coherent sources necessary to produce a sustained interference pattern?
(b) In Young's double slit experiment using monochromatic light of wavelength λ , the intensity of light at a point on the screen where path difference is $\lambda/3$, is K units. Find out the intensity of light at a point where path difference is $\lambda/2$.
27. Use Huygen's principle to explain the formation of diffraction pattern due to a single slit illuminated by a monochromatic source of light.
When the width of slit is made double the original width, how this affect the size and intensity of the central diffraction band?
28. Explain the principle of a device that can build up high voltages of the order of a few million volts.
Draw a schematic diagram and explain the working of this device.
Is there any restriction on the upper limit of the high voltages set up in this machine? Explain.

OR

- (a) Define electric flux. Write its S.I. units.
(b) Using Gauss's law, prove that the electric field at a point due to a uniformly charged infinite plane sheet is independent of the distance from it.
(c) How is the field directed if (i) the sheet is positively charged, (ii) negatively charged?
29. Define magnifying power of a telescope. Write its expression.
A small telescope has an objective lens of focal length 150 cm and an eye piece of focal length 5 cm. If this telescope is used to view a 100 m high tower 3 km away, find the height of the final image when it is formed 25 cm away from the eye piece.

OR

- How is the working of a telescope different from that of a microscope?
The focal lengths of the objective and eyepiece of a microscope are 1.25 cm and 5 cm respectively. Find the position of the object relative to the objective in order to obtain an angular magnification of 30 in normal adjustment.
30. Draw a simple circuit of a CE transistor amplifier. Explain its working. Show that the voltage gain A_V , of the amplifier is given by $A_V = \frac{\beta_{ac} R_L}{r_i}$, where β_{ac} is the current gain, R_L is the load resistance and r_i is the input resistance of the transistor. What is the significance of the negative sign in the expression for the voltage gain?

OR

- (a) Draw the circuit diagram of a full wave rectifier using p-n junction diode. Explain its working and show the output, input waveforms.
- (b) Show the output waveforms (Y) for the following inputs A and B of
 (i) OR gate
 (ii) NAND gate

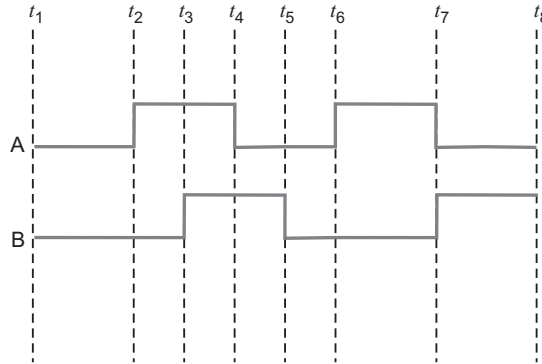
CBSE (Delhi) Set-II
Questions uncommon to Set-I

- Why must electrostatic field be normal to the surface at every point of a charged conductor?
- Predict the direction of induced current in a metal ring when the ring is moved towards a straight conductor with constant speed v . The conductor is carrying current I in the direction shown in the figure.

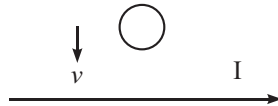

- Derive the expression for the self inductance of a long solenoid of cross sectional area A and length l , having n turns per unit length.
- The susceptibility of a magnetic material is 2.6×10^{-5} . Identify the type of magnetic material and state its two properties.
- Two identical circular loops, P and Q , each of radius r and carrying currents I and $2I$ respectively are lying in parallel planes such that they have a common axis. The direction of current in both the loops is clockwise as seen from O which is equidistant from the both loops. Find the magnitude of the net magnetic field at point O .

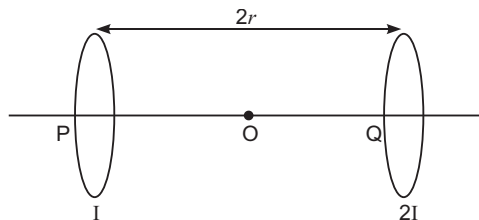

20. A series LCR circuit with $L = 4.0$ H, $C = 100$ F and $R = 60$ is connected to a variable frequency 240 V source as shown in

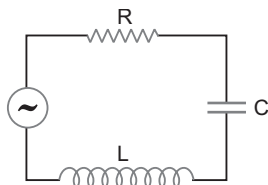

Calculate:

- (i) the angular frequency of the source which derives the circuit at resonance;
 - (ii) the current at the resonating frequency;
 - (iii) the rms potential drop across the inductor at resonance.
21. (a) Why are coherent sources necessary to produce a sustained interference pattern?
- (b) In Young's double slit experiment using mono-chromatic light of wavelength λ , the intensity of light at a point on the screen where path difference is λ , is K units. Find out the intensity of light at a point where path difference is $\frac{2\lambda}{3}$.
22. A rectangular loop of wire of size $2\text{ cm} \times 5\text{ cm}$ carries a steady current of 1 A . A straight long wire carrying 4 A current is kept near the loop as shown in the figure. If the loop and the wire are coplanar, find (i) the torque acting on the loop and (ii) the magnitude and direction of the force on the loop due to current carrying wire.

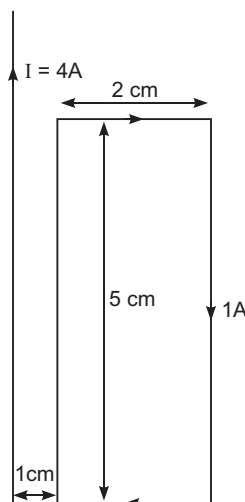

27. Name the three different modes of propagation of electromagnetic waves. Explain, using a proper diagram the mode of propagation used in the frequency range above 40 MHz.

CBSE (Delhi) Set-III

Questions uncommon to Set-I & II

6. Why is electrostatic potential constant throughout the volume of the conductor and has the same value (as inside) on its surface?
8. Predict the direction of induced current in metal rings 1 and 2 when current I in the wire is steadily decreasing?

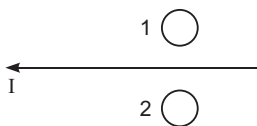

9. The relative magnetic permeability of a magnetic material is 800. Identify the nature of magnetic material and state its two properties.
12. Define mutual inductance between two long coaxial solenoids. Find out the expression for the mutual inductance of inner solenoid of length l having the radius r_1 and the number of turns n_1 per unit length due to the second outer solenoid of same length and n_2 number of turns per unit length.
16. Two identical circular loops, P and Q, each of radius r and carrying equal currents are kept in the parallel planes having a common axis passing through O. The direction of current in P is clockwise and in Q is anti-clockwise as seen from O which is equidistant from the loops P and Q. Find the magnitude of the net magnetic field at O.

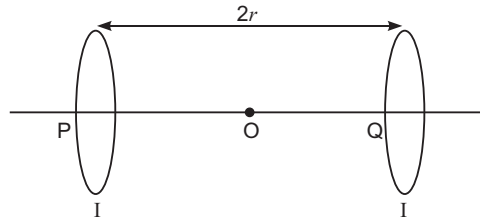

21. Name the three different modes of propagation of electromagnetic waves. Explain, using a proper diagram the mode of propagation used in the frequency range from a few MHz to 40 MHz.
23. A rectangular loop of wire of size $2.5 \text{ cm} \times 4 \text{ cm}$ carries a steady current of 1 A. A straight wire carrying 2 A current is kept near the loop as shown. If the loop and the wire are coplanar, find the (i) torque acting on the loop and (ii) the magnitude and direction of the force on the loop due to the current carrying wire.

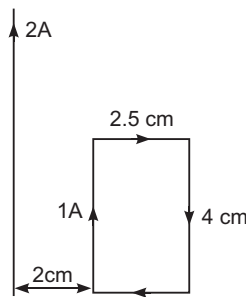

25. The figure shows a series LCR circuit with $L = 10.0 \text{ H}$, $C = 40 \text{ F}$, $R = 60$ connected to a variable frequency 240 V source, calculate
- the angular frequency of the source which drives the circuit at resonance,
 - the current at the resonating frequency,
 - the rms potential drop across the inductor at resonance.

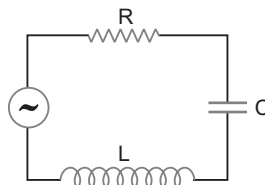

Solutions

CBSE (Delhi) Set-I

1. No.
2. Zero
- 3.

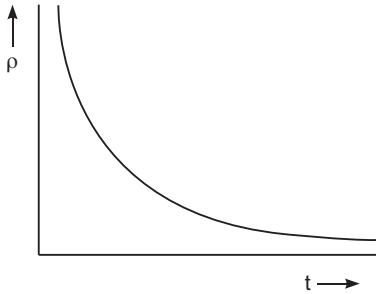

4. The charge inside the conductor is zero, so electric field is zero.
5. Velocity ($c = 3 \times 10^8$ m/s)
This is because both are electromagnetic waves.
6. When $n_L < n_g$
where n_L = Refractive index of liquid and n_g = Refractive index of glass
- 7.



8. According to hypothesis of de Broglie "The atomic particles of matter moving with a given velocity, can display the wave like properties."

i.e., $\frac{h}{mv}$ (mathematically)

- 9.

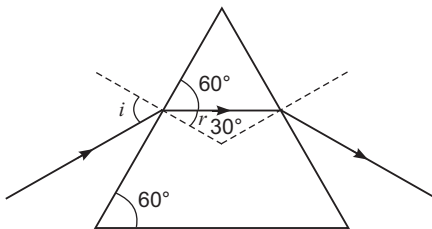

From the figure, we see

$r = 30^\circ$

We know

$$n_{21} \frac{\sin i}{\sin r} = \sqrt{3} \frac{\sin i}{\sin 30}$$

$$\sin i = \sqrt{3} \sin 30 = \sqrt{3} \times \frac{1}{2}$$

$$i = 60$$

10. Analog signals: They are the continuous variations of voltage or current.

Digital signals: They are the signals which can take only discrete values

OR

(i) **Transducer:** A device which converts energy from one form to another form.

(ii) **Repeater:** It is a combination of a receiver and a transmitter.

(iii) **Transmitter:** A device which processes the incoming message signal so as to make it suitable for transmission through a channel and for its subsequent reception.

(iv) **Bandpass filter:** A bandpass filter blocks lower and higher frequencies and allows only a band of frequencies to pass through.

11. (i) $i = \frac{emf}{r}$

where emf

r = Internal resistance

In this situation, effective resistance of circuit is minimum so current is maximum.

So, $i = 4.2$ A

(ii) $i = \frac{emf}{R_1 + r}$

Here, effective resistance is more than (i) and (iv) but less than (iii)

So, $i = 1.05$ A

(iii) $i = \frac{emf}{r + R_1 + R_2}$

In this situation effective resistance is maximum so current is minimum.

So, $i = 0.42$ A

(iv) $i = \frac{emf}{r + \frac{R_1 R_2}{R_1 + R_2}}$

In this situation, the effective resistance is more than (i) but less than (ii) and (iii).

Hence, $i = 1.4$ A

12. The magnetic material having negative susceptibility is diamagnetic in nature.

Two properties:

(i) This material expels the magnetic field lines.

(ii) They have the tendency to move from stronger to weaker part of the external magnetic field.

13.

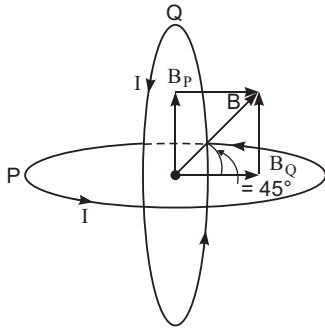

B_p directed vertically upward

B_q horizontally directed

$$B = \sqrt{B_p^2 + B_q^2}$$

We have $B_p = B_q = \frac{0I}{2R}$ $B = \sqrt{2} B_p = \sqrt{2} \frac{I}{2R}$ $B = \frac{I}{\sqrt{2}R}$

The net magnetic field is directed at angle of 45° with either of the fields.

14. When an ideal capacitor is charged by *dc* battery, charge flows (momentarily) till the capacitor gets fully charged.

When an *ac* source is connected then conduction current $i_c = \frac{dq}{dt}$ keep on flowing in the connecting wire. Due to changing current, charge deposited on the plates of the capacitor changes with time. This causes change in electric field between the plates of the capacitor which causes the electric flux to change and gives rise to a displacement current in the region between the plates of the capacitor.

As we know, displacement current

$$i_d = \epsilon_0 \frac{dE}{dt} \quad \text{and} \quad i_d = i_c \quad \text{at all instants.}$$

15. Here $\frac{1}{r^2}$ and $V = \frac{1}{r}$

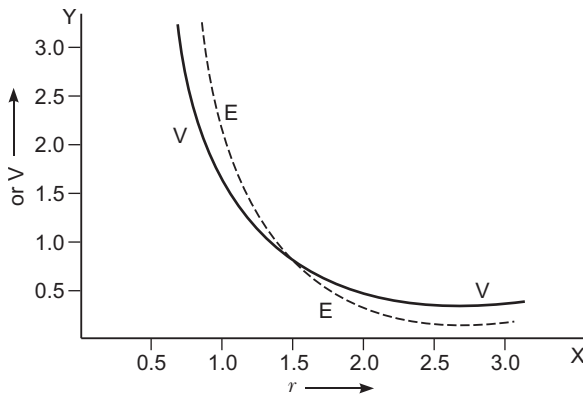

- 16.** Self inductance of a coil is numerically equal to the magnetic flux linked with the coil when the current through coil is 1A.

Energy stored in an inductor:

Consider a source of emf connected to an inductor L . As the current starts growing, the opposing induced emf is given by $e = L \frac{di}{dt}$

If the source of emf sends a current i through the inductor for a small time dt , then the amount of work done by the source, is given by

$$dw = |e| i dt = L i \frac{di}{dt} dt = L i di$$

Hence, the total amount of work done by source of emf when the current increases from its initial values ($i = 0$) to its final value (I) is given by

$$W = \int_0^I L i di = L \int_0^I i di = L \left[\frac{i^2}{2} \right]_0^I$$

$$W = \frac{1}{2} L I^2$$

This work done gets stored in the inductor in the form of energy.

$$U = \frac{1}{2} L I^2$$

- 17.** Consider the case of n -type semiconductor. The majority carrier (electron) density is larger than the minority hole density, i.e., $n \gg p$.

On illumination, the no. of both types of carriers would equally increase in number as

$$n' = n + n, \quad p' = p + p$$

$$\text{But } n \gg p \text{ and } n \gg p$$

Hence, the fractional change in majority carrier, i.e., $\frac{n}{n} \ll \frac{p}{p}$ (fractional change in minority carrier)

Fractional change due to photo-effects on minority carrier dominated reverse bias current is more easily measurable than the fractional change in majority carrier dominated forward bias current. Hence photodiodes are used in reverse bias condition for measuring light intensity.

- 18.** The induced emf = $\frac{d}{dt} B$

$$\frac{d}{dt} (BA) \quad \left| \quad \begin{array}{l} B \quad BA \cos \\ \therefore 0 \\ B \quad BA \end{array} \right.$$

where $\frac{dA}{dt}$ = Rate of change of area of loop formed by the sector OPQ . Let t be the angle between the rod and the radius of the circle at P at time t .

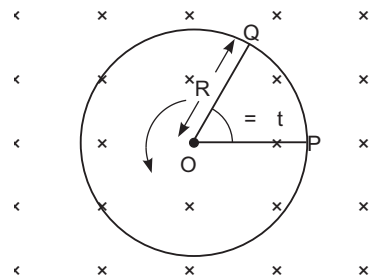

$$\text{The area of the sector } OPQ = R^2 \frac{\theta}{2} = \frac{1}{2} R^2 \theta$$

where R = Radius of the circle.

$$\text{Hence } B \frac{d}{dt} \left(\frac{1}{2} R^2 \theta \right) = \frac{1}{2} B R^2 \frac{d\theta}{dt} = \frac{B}{2} R^2 \frac{d\theta}{dt}$$

19. (i) We know

ω_r = Angular frequency at resonance

$$\omega_r = \frac{1}{\sqrt{LC}} = \frac{1}{\sqrt{5 \times 80 \times 10^{-6}}} = 50 \text{ rad/s}$$

- (ii) Current at resonance

$$I_{rms} = \frac{V_{rms}}{R} = \frac{240}{40} = 6 \text{ A}$$

- (iii) V_{rms} across capacitor

$$V_{rms} = I_{rms} X_C = 6 \times \frac{1}{50 \times 80 \times 10^{-6}} = \frac{6 \times 10^6}{4 \times 10^3} = 1500 \text{ V}$$

20. (i) Torque $\tau = MB \sin \theta$ where $\theta = 0$

Therefore, $\tau = 0$ [\because As M and B are parallel]

- (ii) Force acting on the loop

$$\begin{aligned} |F| &= \frac{1}{2} B I l \left(\frac{1}{r_1} - \frac{1}{r_2} \right) \\ &= 2 \times 10^{-7} \times 2 \times 5 \times 10^{-1} \left(\frac{1}{10^{-2}} - \frac{1}{5 \times 10^{-2}} \right) \\ &= \frac{20 \times 10^{-8}}{10^{-2}} \times \frac{1}{5} \text{ N} = 20 \times 10^{-6} \times \frac{4}{5} \text{ N} = 1.6 \times 10^{-5} \text{ N}. \end{aligned}$$

Direction: Towards the conductor or attractive

21. (i) According to Bohr's second postulate

$$mvr_n = n \frac{h}{2\pi r_n}$$

$$2\pi r_n m v = nh$$

$$\text{But } \frac{h}{m\lambda} = \frac{h}{p} \quad \text{By de Broglie hypothesis}$$

$$2\pi r_n m v = nh$$

- (ii) For third excited state $n = 4$

For ground state $n = 1$

Hence possible transitions are

$$n_i = 4 \quad \text{to} \quad n_f = 3, 2, 1$$

$$n_i = 3 \quad \text{to} \quad n_f = 2, 1$$

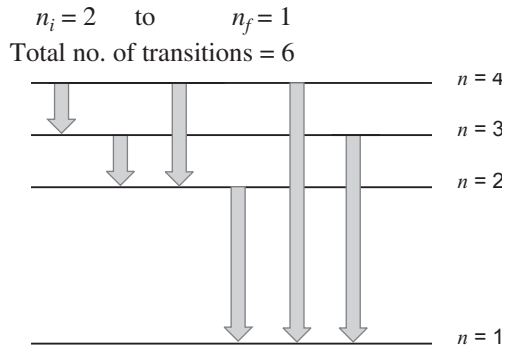

22. (i) Let k = potential gradient in V/cm

$$1 \quad 2 \quad 300k \quad \dots(i)$$

$$1 \quad 2 \quad 120k \quad \dots(ii)$$

We can solve, $\frac{1}{2} = \frac{7}{3}$

- (ii) From equation (i)

$$1 \quad 2 \quad 300k$$

$$1 \quad \frac{3}{7} \quad 1 \quad 300k \quad 1 \quad 210k$$

Therefore, balancing length for cell $_1$ is 210 cm.

- (iii) By decreasing potential gradient

OR

Applying Kirchoff's loop rule for loop ABEFA,

$$-9 + 6 + 4 \times 0 + 2I = 0$$

$$I = 1.5 \text{ A} \quad \dots(i)$$

For loop BCDEB

$$3 + IR + 4 \times 0 - 6 = 0$$

$$IR = 3$$

Putting the value of I from (i) we have

$$\frac{3}{2} R = 3 \quad R = 2$$

Potential difference between A and D

through path ABCD

$$9 - 3 - IR = V_{AD}$$

or $9 - 3 - \frac{3}{2} \times 2 = V_{AD} \quad V_{AD} = 3V$

23. (i) Saturation or short range nature of nuclear forces.

- (ii) We have

$$R \propto R_0 A^{1/3}$$

Let m = mass of nucleon

$$\text{Density } (\rho) = \frac{mA}{\frac{4}{3} R_0 A^{1/3}} = \frac{mA}{\frac{4}{3} R_0^3 A} = \frac{m}{\frac{4}{3} R_0^3}$$

Hence ρ is independent of A .

24. Two factors justifying the need for modulation:

- (i) Practical size of antenna
- (ii) To avoid mixing up of signals from different transmitters.

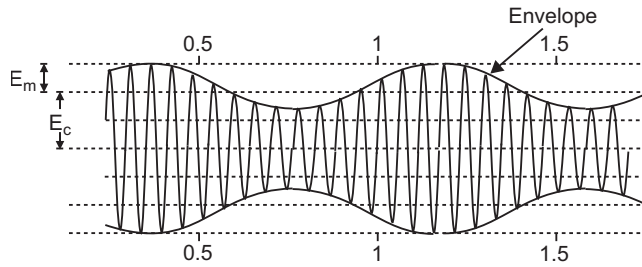

(amplitude modulated wave)

25. Einstein photo electric equation is $h\nu = \phi_0 + K_{\max}$.

The energy ($h\nu$) carried by a photon of frequency ν is absorbed by electrons on the surface to

- (i) overcome the work function of metal ϕ_0 .
- (ii) impart maximum K.E. to the emitted electron (K_{\max}).

$$h\nu = \phi_0 + K_{\max}$$

Three salient features are:

- (i) Cut-off potential of the emitted electrons is proportional to $\nu - \nu_0$.
- (ii) Photo electric emission of electrons is possible only when $\nu > \nu_0 = \frac{\phi_0}{h}$.
- (iii) Max. K.E. is independent of intensity of incident radiations.

26. (a) This is because coherent sources are needed to ensure that the positions maxima and minima do not change with time.

(b) We know

$$I = 4I_0 \cos^2 \frac{\phi}{2}$$

for path difference λ , phase difference 2π

Intensity of light = $4I_0$

$$\text{Hence, } K = 4I_0 \cos^2 \frac{\phi}{2} = 4I_0$$

For path difference $\frac{\lambda}{3}$, Phase difference $\frac{2\pi}{3}$

$$\text{Intensity of light } I' = 4I_0 \cos^2 \frac{\phi}{2} = 4I_0 \cos^2 \frac{\phi}{3} = I_0$$

$$I = \frac{K}{4}$$

27. According to Huygen's principle "The net effect at any point due to a number of wavelets is equal to sum total of contribution of all wavelets with proper phase difference.

The point O is maxima because contribution from each half of the slit S_1S_2 is in phase, *i.e.*, the path difference is zero.

At point P

- (i) If $S_2P - S_1P = n$ the point P would be minima.

- (ii) If $S_2P - S_1P = (2n - 1)\frac{\lambda}{2}$ the point would be

maxima but with decreasing intensity.

$$\text{The width of central maxima} = \frac{2 \lambda D}{a}$$

When the width of the slit is made double the original width, then the size of central maxima will be reduced to half and intensity will be four times.

28. Van de Graaff, in 1931 designed an electrostatic generator which is capable of producing very high potential of the order of 10 MV.

Principle: Suppose we have a large spherical conducting shell of radius R , carrying charge Q . The charge spreads uniformly over whole surface of the shell. Now suppose a small conducting sphere of radius ' r ' is introduced inside the spherical shell and placed at its centre, so that both the sphere and shell have same centre O . The electric field in the region inside the small sphere and large shell is due to charge q only, so electric field strength at a distance x from the centre O is

$$E = \frac{1}{4\pi\epsilon_0} \frac{q}{x^2}, \text{ directed radially outward}$$

The potential difference between the sphere and the shell

$$V(r) - U(R) = \int_R^r E \cdot dx$$

$$= \int_R^r \frac{1}{4\pi\epsilon_0} \frac{q}{x^2} dx = \frac{q}{4\pi\epsilon_0} \left[\frac{1}{x} \right]_R^r = \frac{q}{4\pi\epsilon_0} \left(\frac{1}{r} - \frac{1}{R} \right)$$

This is independent of charge Q on the large spherical shell. As $r < R$; $V(r) - U(R)$ is positive. As charge flows from higher to lower potentials therefore, if we connect the small sphere and large shell by a conducting wire, the charge flows from sphere to outer shell whatsoever the charge on outer shell may be. This forms the principle of Van de Graaff generator. The maximum charge that may be given to outer shell which may cause discharge in air.

Construction. It consists of a large hollow metallic sphere S mounted on two insulating columns A and B and an endless belt of rubber or silk is made to run on two pulleys P_1 and P_2 by the means of an electric motor. C_1 and C_2 are two sharp metallic spikes in the form of combs. The lower comb C_1 is connected to the positive terminal of a very high voltage source (HTS) (10^4 volts.) and the upper comb C_2 is connected to the inner surface of metallic sphere S .

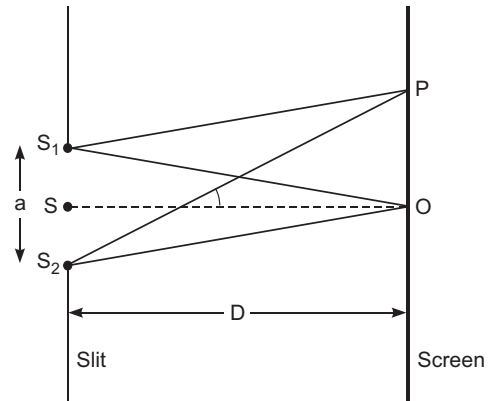

Working: When comb C_1 is given very high potential, then it produces ions in its vicinity, due to action of sharp points. The positive ions, so produced, get sprayed on the belt due to the repulsion between positive ions and comb C_1 . These positive ions are carried upward by the moving belt. The pointed end of C_2 just touches the belt. The comb C_2 collects positive charge from the belt which immediately moves to the outer surface of sphere S . As the belt goes on revolving, it continues to take () charge upward, which is collected by comb C_2 and transferred to outer surface of sphere S . Thus the outer surface of metallic sphere S gains positive charge continuously and its potential rises to a very high value.

When the potential of a metallic sphere gains very high value, the dielectric strength of surrounding air breaks down and its charge begins to leak, to the surrounding air. The maximum potential is reached when the rate of leakage of charge becomes equal to the rate of charge transferred to the sphere. To prevent leakage of charge from the sphere, the generator is completely enclosed in an earthed connected steel tank which is filled with air under high pressure.

Van de Graaff generator is used to accelerate stream of charged particles to very high velocities. Such a generator is installed at IIT Kanpur which accelerates charged particles upto 2 MeV energy.

Yes, the high voltages can be built up to the breakdown field of the surrounding medium.

OR

- (a) Electric flux: It is defined as the total number of electric field lines passing through an area normal to them:

Also, $\oint E \cdot ds$

The SI unit is Nm^2/C or volt-metre.

- (b) **Gauss's Theorem**

It states that the total electric flux through a closed surface is equal to $\frac{1}{\epsilon_0}$ times the net charge

enclosed by the surface

$$\text{i.e.,} \quad \oint_s \mathbf{E} \cdot d\mathbf{S} = \frac{1}{\epsilon_0} q$$

Let electric charge be uniformly distributed over the surface of a thin, non-conducting infinite sheet. Let the surface charge density (i.e., charge per unit surface area) be σ . We have to calculate the electric field strength at any point distance r from the sheet of charge.

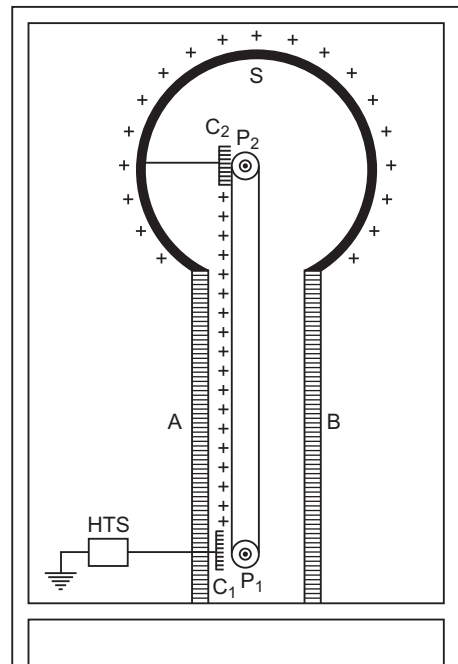

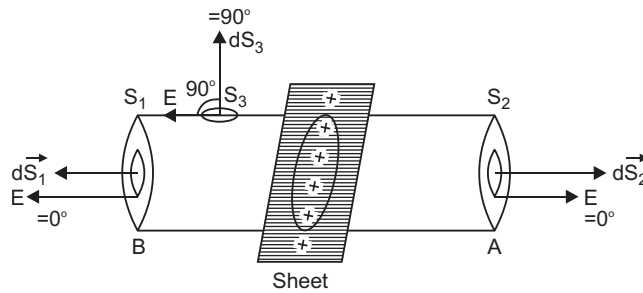

To calculate the electric field strength near the sheet, we now consider a cylindrical Gaussian surface bounded by two plane faces A and B lying on the opposite sides and parallel to the charged sheet and the cylindrical surface perpendicular to the sheet (fig). By symmetry the electric field strength at every point on the flat surface is the same and its direction is normal outwards at the points on the two plane surfaces and parallel to the curved surface.

Total electric flux

$$\oint_S \mathbf{E} \cdot d\mathbf{S} = \oint_{S_1} \mathbf{E} \cdot d\mathbf{S}_1 + \oint_{S_2} \mathbf{E} \cdot d\mathbf{S}_2 + \oint_{S_3} \mathbf{E} \cdot d\mathbf{S}_3$$

$$\text{or } \oint_S \mathbf{E} \cdot d\mathbf{S} = \int_{S_1} E dS_1 \cos 0 + \int_{S_2} E dS_2 \cos 0 + \int_{S_3} E dS_3 \cos 90$$

$$E \int dS_1 + E \int dS_2 + E a + E a + 2E a$$

Total electric flux $2Ea$.

As σ is charge per unit area of sheet and a is the intersecting area, the charge enclosed by Gaussian surface $q = \sigma a$

According to Gauss's theorem,

$$\text{Total electric flux} = \frac{1}{\epsilon_0} (\text{total charge enclosed by the surface})$$

$$\text{i.e., } 2Ea = \frac{1}{\epsilon_0} (\sigma a)$$

$$E = \frac{\sigma}{2\epsilon_0}$$

Thus electric field strength due to an infinite flat sheet of charge is independent of the distance of the point and is directed normally away from the charge. If the surface charge density σ is negative the electric field is directed towards the surface charge.

(c) (i) Away from the charged sheet.

(ii) Towards the plane sheet.

29. (a) Magnifying power of telescope is the ratio of the angle subtended at the eye by the image to the angle subtended at the unaided eye by the object.

$$m = \frac{f_0}{f_e} \quad \text{or} \quad m = \frac{f_0}{f_e} \approx 1 + \frac{f_e}{D}$$

(b) Using, the lens equation for objective lens.

$$\frac{1}{f_0} = \frac{1}{v_0} + \frac{1}{u_0}$$

$$\frac{1}{150} = \frac{1}{v_0} + \frac{1}{3 \times 10^5}$$

$$\frac{1}{150} - \frac{1}{3 \times 10^5} = \frac{1}{v_0}$$

$$v_0 = \frac{3 \times 10^5}{1999} \text{ cm} \approx 150 \text{ cm}$$

Hence, magnification due to the objective lens

$$m_0 = \frac{v_0}{u_0} = \frac{150 \times 10^{-2} \text{ m}}{3000 \text{ m}} \approx \frac{10^{-2}}{20}$$

$$m_0 = 0.05 \times 10^{-2}$$

Using lens formula for eye piece

$$\frac{1}{f_e} = \frac{1}{v_e} + \frac{1}{u_e}$$

$$\frac{1}{5} = \frac{1}{25} + \frac{1}{u_e} \quad u_e = \frac{25}{6} \text{ cm}$$

$$\text{Magnification due to eyepiece } m_e = \frac{25}{\frac{25}{6}} = 6$$

Hence, total magnification $m = m_e \times m_0$

$$m = 6 \times 5 \times 10^{-4} = 30 \times 10^{-4}$$

Hence, size of final image = $30 \times 10^{-4} \times 100 \text{ m} = 30 \text{ cm}$

OR

(a) **Difference in working of telescope and microscope**

- (i) Objective of telescope forms the image of a very far off object at or within the focus of its eyepiece. The microscope does the same for a small object kept just beyond the focus of its objective.
- (ii) The final image formed by a telescope is magnified relative to its size as seen by the unaided eye while the final image formed by a microscope is magnified relative to its absolute size.
- (iii) The objective of a telescope has large focal length and large aperture while the corresponding for a microscope have very small values.

(b) Given $f_o = 1.25 \text{ cm}$, $f_e = 5 \text{ cm}$

Angular magnification $m = 30$

Now, $m = m_e \times m_o$

In normal adjustment, angular magnification of eyepiece

$$m_e \frac{d}{f_e} = + \frac{25}{5} = 5$$

Hence m_0 6

But $m_0 \frac{v_0}{u_0}$

$$6 \frac{v_0}{u_0} \quad v_0 = 6u_0$$

Applying lens equation to the objective lens

$$\frac{1}{f_0} - \frac{1}{v_0} = \frac{1}{u_0} \quad \frac{1}{1.25} = \frac{1}{6u_0} - \frac{1}{u_0}$$

$$u_0 = 1.46 \text{ cm} = -1.5 \text{ cm}$$

30. Circuit diagram of CE transistor Amplifier.

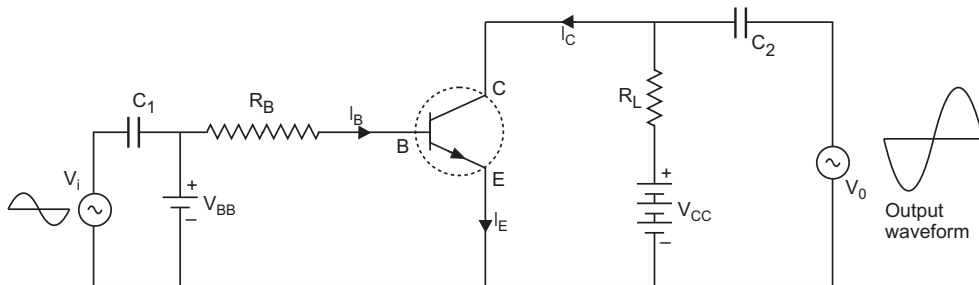

When an *ac* input signal V_i (to be amplified) is superimposed on the bias V_{BB} , the output, which is measured between collector and ground, increases.

We first assume that $V_i = 0$. Then applying Kirchhoff's law to the output loop.

$$V_{CC} - V_{CE} - I_C R_L = 0$$

Similarly the input loop gives

$$V_{BB} - V_{BE} - I_B R_B = 0$$

When V_i is not zero, we have

$$\begin{aligned} V_{BE} - V_i - V_{BE} - I_B R_B - I_B (R_B + R_i) &= 0 \\ V_i - I_B (R_B + R_i) &= -I_B (R_B + R_i) \end{aligned}$$

Change in I_B causes a change in I_C

$$\text{Hence, } \frac{\Delta I_C}{I_C} = \beta \frac{\Delta I_B}{I_B}$$

$$\text{As } V_{CC} - V_{CE} - R_L I_C = 0 \quad V_{CE} = R_L I_C$$

The change in V_{CE} is the output voltage V_0

$$V_0 = R_L \Delta I_C = \beta R_L \Delta I_B$$

The voltage gain of the amplifier is

$$A_V = \frac{V_0}{V_i} = \frac{V_{CE}}{r I_B} = \frac{ac I_B R_L}{r I_B} = \frac{ac R_L}{r}$$

Negative sign in the expression shows that output voltage and input voltage have phase difference of π .

OR

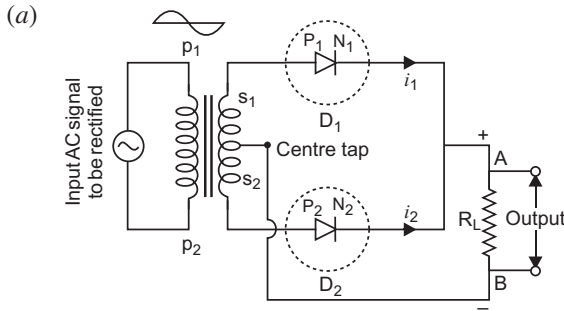

Working: The AC input voltage across secondary s_1 and s_2 changes polarity after each half cycle. Suppose during the first half cycle of input AC signal, the terminal s_1 is positive relative to centre tap O and s_2 is negative relative to O . Then diode D_1 is forward biased and diode D_2 is reverse biased. Therefore, diode D_1 conducts while diode D_2 does not. The direction of current (i_1) due to diode D_1 in load resistance R_L is directed from A to B . In next half cycle, the terminal s_1 is negative and s_2 is positive relative to centre tap O . The diode D_1 is reverse biased and diode D_2 is forward biased. Therefore, diode D_2 conducts while D_1 does not. The direction of current (i_2) due to diode D_2 in load resistance R_L is still from A to B . Thus the current in load resistance R_L is in the same direction for both half cycles of input AC voltage. Thus for input AC signal the output current is a continuous series of unidirectional pulses.

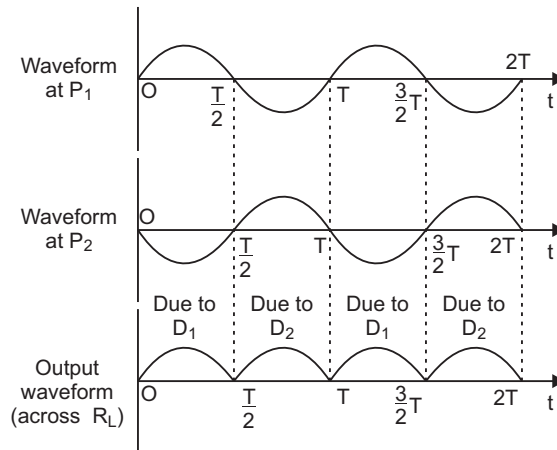

In a full wave rectifier, if input frequency is f hertz, then output frequency will be $2f$ hertz because for each cycle of input, two positive half cycles of output are obtained.

(b) Output waveforms for the following inputs A and B of OR gate and NAND gate.

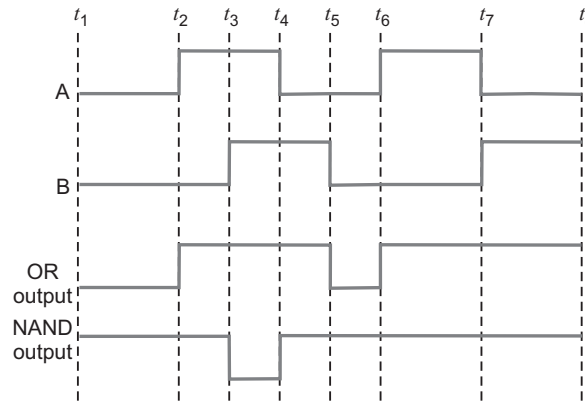

CBSE (Delhi) Set-II

1. In the static situation, E has to ensure that the free charges on the surface do not experience any force.
6. Clockwise
10. Magnetic field inside the solenoid

$$B = \mu_0 n I$$

n number of turns per unit length, I current flowing,

$$= \text{Magnetic field through each turn} = \mu_0 n I A$$

Total magnetic flux linked with solenoid

$$N \Phi = n l \mu_0 n I A = \mu_0 n^2 A I l \quad L = \mu_0 n^2 A l$$

L self inductance of solenoid and l length of solenoid.

14. The material having positive susceptibility is paramagnetic material.

Properties

- (i) They have tendency to move from a region of weak magnetic field to strong magnetic field, i.e., they get weakly attracted to a magnet.
- (ii) When a paramagnetic material is placed in an external field the field lines get concentrated inside the material, and the field inside is enhanced.

- 16.

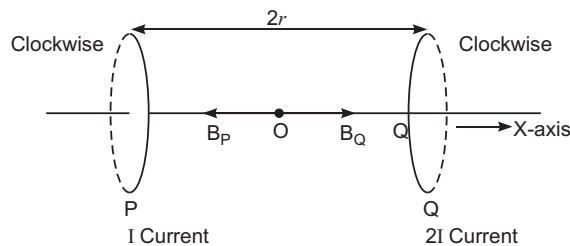

$$|B_P| = \frac{\mu_0 r^2 I}{2(r^2 - r^2)^{3/2}} = \frac{\mu_0 I}{4\sqrt{2}r} \quad \text{Pointing towards } P$$

$$|B_Q| = \frac{\mu_0 (2I)r^2}{2(r^2 - r^2)^{3/2}} = \frac{\mu_0 I}{4\sqrt{2}r} \quad \text{Pointing towards } Q$$

$$|B| = |B_Q| - |B_P| = \frac{\mu_0 I}{4\sqrt{2}r}$$

So, magnetic field at point O has a magnitude $\frac{\mu_0 I}{4\sqrt{2}r}$

20. (i) $\frac{1}{\sqrt{LC}} \frac{1}{\sqrt{4 \times 100 \times 10^{-6}}} = 50 \text{ rad/s}$

(ii) $I = \frac{240}{60} = 4 \text{ A}$

(iii) $V_L = I X_L = I L = 4 \times 50 \times 4 = 800 \text{ V}$

21. (a) Coherent sources are needed to ensure that the positions of maxima and minima do not change with time.

(b) We know that

$$\frac{I}{I} = \frac{I_1 + I_2 + 2\sqrt{I_1 I_2} \cos \frac{\phi}{2}}{4I_0 \cos^2 \frac{\phi}{2}} \quad (I_1 = I_2 = I_0)$$

For path difference $\lambda/3$, phase difference $2\pi/3$

Thus, $\frac{K}{4I_0} = \frac{4I_0 \cos^2 \frac{2\pi/3}{2}}{4I_0}$

When path difference = $\frac{2\lambda}{3}$

Phase difference, $\frac{4\pi}{3}$

Hence, intensity, $I' = 4I_0 \cos^2 \frac{4\pi/3}{2} = 4I_0 \left(\frac{1}{2}\right)^2 = I_0 \frac{K}{4}$

22. (i) Torque = $MB \sin \theta$

As M and B are parallel. So $\theta = 0$.

(ii) Force acting on the loop

$$F = \frac{\mu_0 i_1 i_2 l}{2} \left[\frac{1}{r_1} - \frac{1}{r_2} \right]$$

$$= 2 \times 10^{-7} \times 4 \times 1 \times 5 \times 10^{-2} \left[\frac{1}{10^{-2}} - \frac{1}{3 \times 10^{-2}} \right]$$

$$= 40 \times 10^{-7} \times \frac{2}{3} \text{ N} = \frac{80}{3} \times 10^{-7} \text{ N} = 26.66 \times 10^{-7} \text{ N} = 2.67 \times 10^{-6} \text{ N}$$

Direction: Towards the conductor or attractive.

27. Three mode of propagation of electromagnetic waves are: (i) Ground waves, (ii) Sky waves, (iii) Space waves

(a) LOS (Line of Sight) Communication

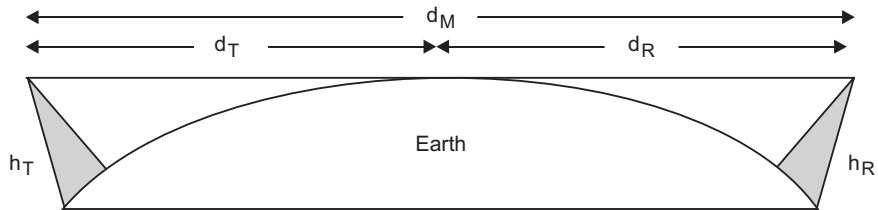

(b) Satellite communication

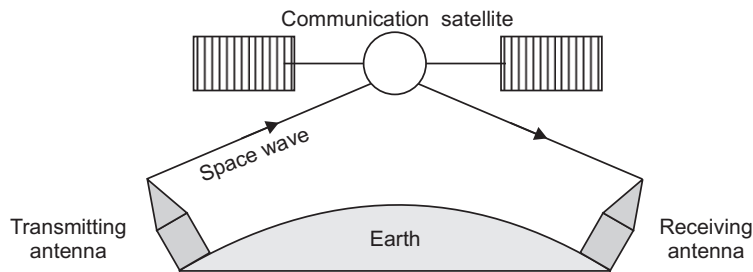

Above 40 MHz, the mode of propagation used is via space waves a space wave travels in a straight line from the transmitting antenna to the receiving antenna.

Space waves are used for the line of sight (LOS) communication as well as satellite communication.

CBSE (Delhi) Set-III

6. Electric field intensity is zero throughout the volume and the potential just inside, has to be equal to potential on the surface.
Magnetic field along X -direction.
8. In coil 1, clockwise
In coil 2, anticlockwise
9. The magnetic material is paramagnetic in nature.
For properties
The material having positive susceptibility is paramagnetic material.
Properties
- They have tendency to move from a region of weak magnetic field to strong magnetic field, *i.e.*, they get weakly attracted to a magnet.
 - When a paramagnetic material is placed in an external field the field lines get concentrated inside the material, and the field inside is enhanced.
12. Mutual Inductance: It is defined as the magnetic flux linked to the second coil when unit current is flowing in the first coil.

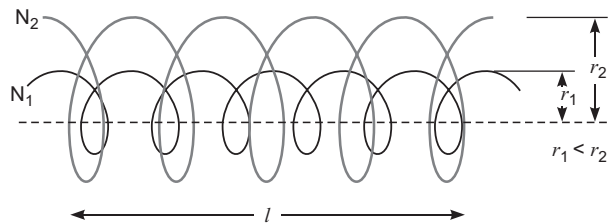

$$M_{12} = \frac{\mu_0 N_1 N_2}{l} \pi r_1^2$$

16.

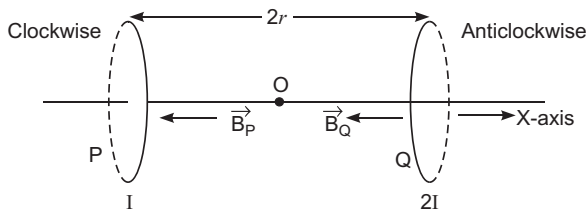

$$|B_P| = \frac{\mu_0 I r^2}{2(r^2 + r^2)^{3/2}} = \frac{\mu_0 I}{4\sqrt{2}r} = |B_Q| \quad \text{Pointing towards } P$$

$$|B| = |B_P| + |B_Q| = 2 \frac{\mu_0 I}{4\sqrt{2}r} = \frac{\mu_0 I}{2\sqrt{2}r}$$

So, the net magnetic field at the point O has magnitude $\frac{\mu_0 I}{2\sqrt{2}r}$.

21. Three mode of propagation of electromagnetic wave

- (i) Ground wave propagation
- (ii) Sky wave propagation
- (iii) Space wave propagation.

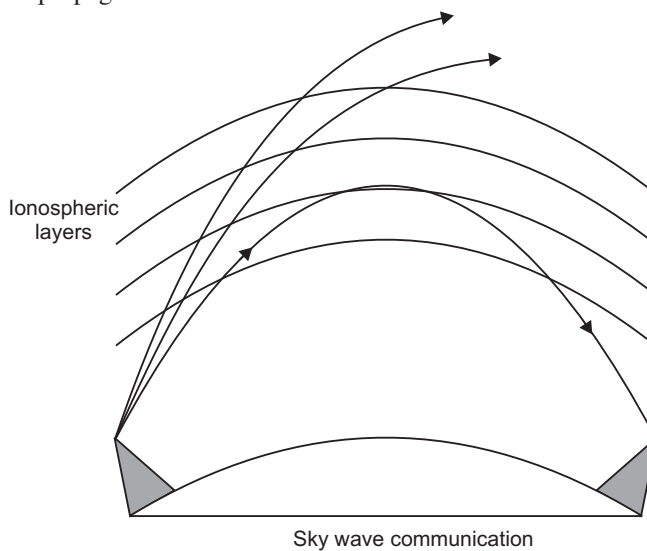

The Ionospheric layers act as a reflector for a certain range of frequencies (from few MHz to 40MHz). Hence these waves reach from the transmitting antenna to the receiving antenna via their reflection from the ionosphere.

23. (i) Torque on the loop $\tau = MB \sin \theta$ $\theta = 0$ $M \parallel B$

$$= 0 \quad [\because M \text{ and } B \text{ are parallel}]$$

(ii) Magnitude of force

$$\begin{aligned} |F| &= \frac{\mu_0 I_1 I_2 l}{2 r_1 r_2} \\ &= 2 \times 10^{-7} \times 2 \times 1 \times 4 \times 10^{-2} \times \frac{1}{2 \times 10^{-2}} \times \frac{1}{45 \times 10^{-2}} \\ &= 16 \times 10^{-7} \times \frac{45 \times 2}{2 \times 45} = \frac{8 \times 5 \times 10^{-7}}{9} = 4.44 \times 10^{-7} \text{N} \end{aligned}$$

Direction of force is towards conductor (attractive).

25. (i) $\frac{1}{\sqrt{LC}} = \frac{1}{\sqrt{10 \times 40 \times 10^{-6}}} = 50 \text{ rad/s}$

(ii) Current at resonance

$$I_{rms} = \frac{V_{rms}}{R} = \frac{240}{60} = 4 \text{A}$$

(iii) V_{rms} across inductor

$$V_{rms} = I_{rms} \times L = 4 \times 50 \times 10 = 2000 \text{V}$$

CBSE EXAMINATION PAPERS

ALL INDIA-2012

Time allowed: 3 hours

Maximum marks: 70

General Instructions: As given in CBSE Examination Papers Delhi-2011.

CBSE (All India) Set-I

- Two wires of equal length, one of copper and the other of manganin have the same resistance. Which wire is thicker?
- What are the directions of electric and magnetic field vectors relative to each other and relative to the direction of propagation of electromagnetic waves?
- How does the angular separation between fringes in single-slit diffraction experiment change when the distance of separation between the slit and screen is doubled?
- A bar magnet is moved in the direction indicated by the arrow between two coils PQ and CD . Predict the directions of induced current in each coil



- For the same value of angle incidence, the angles of refraction in three media A , B and C are 15° , 25° and 35° respectively. In which medium would the velocity of light be minimum?
- A proton and an electron have same kinetic energy. Which one has greater de-Broglie wavelength and why?
- Mention the two characteristic properties of the material suitable for making core of a transformer.
- A charge ' q ' is placed at the centre of a cube of side l . What is the electric flux passing through each face of the cube?
- A test charge ' q ' is moved without acceleration from A to C along the path from A to B and then from B to C in electric field E as shown in the figure. (i) Calculate the potential difference between A and C . (ii) At which point (of the two) is the electric potential more and why?

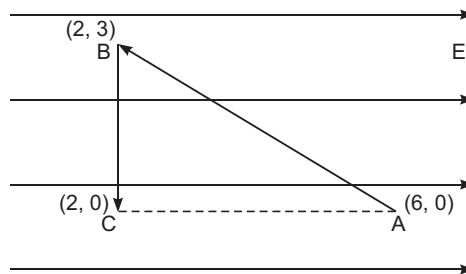

10. An electric dipole is held in a uniform electric field.
- Show that the net force acting on it is zero.
 - The dipole is aligned parallel to the field. Find the work done in rotating it through the angle of 180°
11. State the underlying principle of a transformer. How is the large scale transmission of electric energy over long distances done with the use of transformers?
12. A capacitor of capacitance of 'C' is being charged by connecting it across a dc source along with an ammeter. Will the ammeter show a momentary deflection during the process of charging? If so, how would you explain this momentary deflection and the resulting continuity of current in the circuit? Write the expression for the current inside the capacitor.
13. An object AB is kept in front of a concave mirror as shown in the figure.

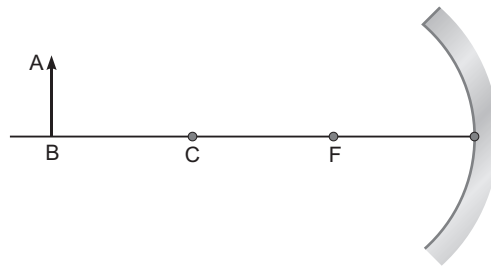

- Complete the ray diagram showing the image formation of the object.
 - How will the position and intensity of the image be affected if the lower half of the mirror's reflecting surface is painted black?
14. Draw a labelled ray diagram of a reflecting telescope. Mention its two advantages over the refracting telescope.
15. Describe briefly with the help of a circuit diagram, how the flow of current carries in a p-n-p transistor is regulated with emitter-base junction forward biased and base-collector junction reverse biased.
16. In the given block diagram of a receiver, identify the boxes labelled as X and Y and write their functions.

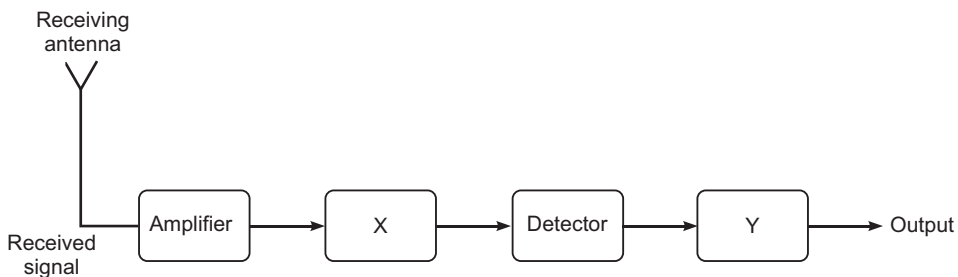

17. A light bulb is rated 100 W for 220 V ac supply of 50 Hz. Calculate
- the resistance of the bulb;
 - the rms current through the bulb

OR

An alternating voltage given by $V = 140 \sin 314 t$ is connected across a pure resistor of 50Ω . Find

- (i) the frequency of the source.
- (ii) the rms current through the resistor.

18. A circular coil of N turns and radius R carries a current I . It is unwound and rewound to make another coil of radius $R/2$, current I remaining the same. Calculate the ratio of the magnetic moments of the new coil and the original coil.
19. Deduce the expression for the electrostatic energy stored in a capacitor of capacitance ' C ' and having charge ' Q '.
How will the (i) energy stored and (ii) the electric field inside the capacitor be affected when it is completely filled with a dielectric material of dielectric constant ' K '?
20. Calculate the value of the resistance R in the circuit shown in the figure so that the current in the circuit is 0.2 A . What would be the potential difference between points B and E ?

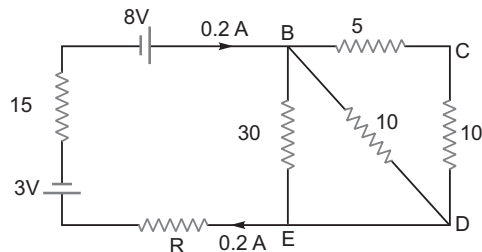

21. You are given three lenses L_1 , L_2 and L_3 each of focal length 20 cm . An object is kept at 40 cm in front of L_1 , as shown. The final real image is formed at the focus ' I ' of L_3 . Find the separations between L_1 , L_2 and L_3 .

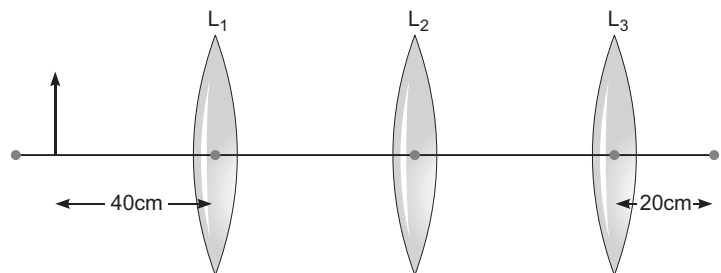

22. Define the terms (i) 'cut-off voltage' and (ii) 'threshold frequency' in relation to the phenomenon of photoelectric effect.
Using Einstein's photoelectric equation show how the cut-off voltage and threshold frequency for a given photosensitive material can be determined with the help of a suitable plot/graph.
23. A series LCR circuit is connected to an ac source. Using the phasor diagram, derive the expression for the impedance of the circuit. Plot a graph to show the variation of current with frequency of the source, explaining the nature of its variation.
24. Mention three 'different modes of propagation used in communication system. Explain with the help of a diagram how long distance communication can be achieved by ionospheric reflection of radio waves.

25. Draw a plot of potential energy of a pair of nucleons as a function of their separations. Mark the regions where the nuclear force is (i) attractive and (ii) repulsive. Write any two characteristic features of nuclear forces.
26. In a Geiger–Marsden experiment, calculate the distance of closest approach to the nucleus of $Z = 80$, when an α -particle of 8 MeV energy impinges on it before it comes momentarily to rest and reverses its direction.
How will the distance of closest approach be affected when the kinetic energy of the α -particle is doubled?

OR

- The ground state energy of hydrogen atom is -13.6 eV. If an electron makes a transition from an energy level -0.85 eV to -3.4 eV, calculate the wavelength of the spectral line emitted. To which series of hydrogen spectrum does this wavelength belong?
27. Define relaxation time of the free electrons drifting in a conductor. How is it related to the drift velocity of free electrons? Use this relation to deduce the expression for the electrical resistivity of the material.
28. (a) In Young’s double slit experiment, derive the condition for (i) constructive interference and (ii) destructive interference at a point on the screen.
(b) A beam of light consisting of two wavelengths, 800 nm and 600 nm is used to obtain the interference fringes in a Young’s double slit experiment on a screen placed 1.4 m away. If the two slits are separated by 0.28 mm, calculate the least distance from the central bright maximum where the bright fringes of the two wavelengths coincide.

OR

- (a) How does an unpolarised light incident on a polaroid get polarised?
Describe briefly, with the help of a necessary diagram, the polarisation of light by reflection from a transparent medium.
- (b) Two polaroids ‘A’ and ‘B’ are kept in crossed position. How should a third polaroid ‘C’ be placed between them so that the intensity of polarised light transmitted by polaroid B reduces to $1/8$ th of the intensity of unpolarised light incident on A?
29. (a) Describe briefly, with the help of a diagram, the role of the two important processes involved in the formation of a p - n junction.
(b) Name the device which is used as a voltage-regulator. Draw the necessary circuit diagram and explain its working.

OR

- (a) Explain briefly the principle on which a transistor-amplifier works as an oscillator. Draw the necessary circuit diagram and explain its working.
(b) Identify the equivalent gate for the following circuit and write its truth table.

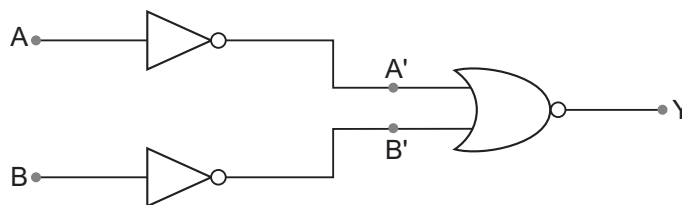

30. (a) Write the expression for the force, F , acting on a charged particle of charge ' q ', moving with a velocity v in the presence of both electric field E and magnetic field B . Obtain the condition under which the particle moves undeflected through the fields.
- (b) A rectangular loop of size $l \times b$ carrying a steady current I is placed in a uniform magnetic field B . Prove that the torque acting on the loop is given by $\tau = m \times B$, where m is the magnetic moment of the loop.

OR

- (a) Explain, giving reasons, the basic difference in converting a galvanometer into (i) a voltmeter and (ii) an ammeter.
- (b) Two long straight parallel conductors carrying steady current I_1 and I_2 are separated by a distance ' d '. Explain briefly, with the help of a suitable diagram, how the magnetic field due to one conductor acts on the other. Hence deduce the expression for the force acting between the conductors. Mention the nature of this force.

CBSE (All India) Set-II

Questions uncommon to Set-I

2. A charge q is placed at the centre of a cube of side l . What is the electric flux passing through two opposite faces of the cube?
5. A proton and an electron have same velocity. Which one has greater de-Broglie wavelength and why?
8. In a single-slit diffraction experiment, the width of the slit is made double the original width. How does this affect the size and intensity of the central diffraction band?
11. A test charge ' q ' is moved without acceleration from A to C along the path from A to B and then from B to C in electric field E as shown in the figure. (i) Calculate the potential difference between A and C . (ii) At which point (of the two) is the electric potential more and why?
16. A light bulb is rated 200 W for 220 V ac supply of 50 Hz. Calculate
- the resistance of the bulb;
 - the rms current through the bulb.

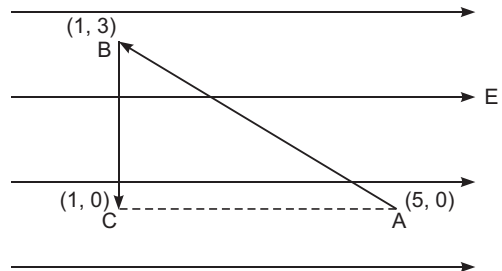

OR

- An alternating voltage given by $V = 280 \sin 50 \pi t$ is connected across a pure resistor of 40Ω . Find
- the frequency of the source.
 - the rms current through the resistor.
17. A circular coil of ' N ' turns and diameter ' d ' carries a current ' I '. It is unwound and rewound to make another coil of diameter ' $2d$ ', current ' I ' remaining the same. Calculate the ratio of the magnetic moments of the new coil and the original coil.

19. You are given three lenses L_1 , L_2 and L_3 each of focal length 15 cm. An object is kept at 20 cm in front of L_1 , as shown. The final real image is formed at the focus 'I' of L_3 . Find the separations between L_1 , L_2 and L_3 .

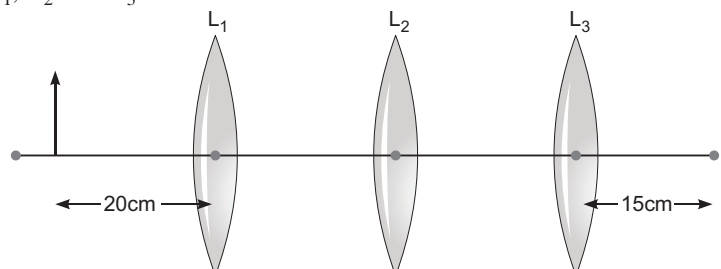

23. Calculate the value of the resistance R in the circuit shown in the figure so that the current in the circuit is 0.2 A. What would be the potential difference between points A and B?

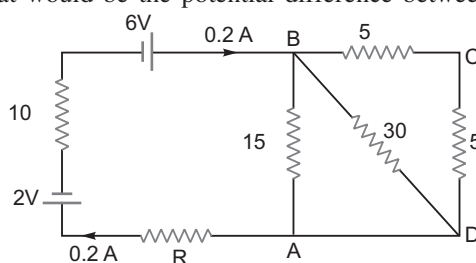

27. In a Geiger– Marsden experiment, calculate the distance of closest approach to the nucleus of $Z = 75$, when an α -particle of 5 MeV energy impinges on it before it comes momentarily to rest and reverses its direction.

How will the distance of closest approach be affected when the kinetic energy of the α -particle is doubled?

OR

The ground state energy of hydrogen atom is -13.6 eV. If an electron makes a transition from an energy level -0.85 eV to -1.51 eV, calculate the wavelength of the spectral line emitted. To which series of hydrogen spectrum does this wavelength belong?

CBSE (All India) Set–III

Questions uncommon to Set – I & II

- How does the fringe width, in Young's double-slit experiment, change when the distance of separation between the slits and screen is doubled?
- A charge ' q ' is placed at the centre of a cube. What is the electric flux passing through the cube?
- The speed of an electromagnetic wave in a material medium is given by $v = \frac{1}{\sqrt{\mu \epsilon}}$, being the permeability of the medium and ϵ its permittivity. How does its frequency change?
- A circular coil of closely wound N turns and radius r carries a current I . Write the expressions for the following:
 - the magnetic field at its centre
 - the magnetic moment of this coil

10. Describe briefly with the help of a circuit diagram, the paths of current carriers in an $n-p-n$ transistor with emitter-base junction forward biased and base-collector junction reverse biased.
12. A light bulb is rated 150 W for 220 V ac supply of 60 Hz. Calculate
 (i) the resistance of the bulb;
 (ii) the rms current through the bulb.

OR

An alternating voltage given by $V = 70 \sin 100 \pi t$ is connected across a pure resistor of 25Ω . Find

- (i) the frequency of the source.
 (ii) the rms current through the resistor.
16. A test charge ' q ' is moved without acceleration from A to C along the path from A to B and then from B to C in electric field E as shown in the figure. (i) Calculate the potential difference between A and C. (ii) At which point (of the two) is the electric potential more and why?
20. Explain briefly the following terms used in communication system:
 (i) Transducer
 (ii) Repeater
 (iii) Amplification
22. You are given three lenses L_1 , L_2 and L_3 each of focal length 10 cm. An object is kept at 15 cm in front of L_1 , as shown. The final real image is formed at the focus ' I ' of L_3 . Find the separations between L_1 , L_2 and L_3 .

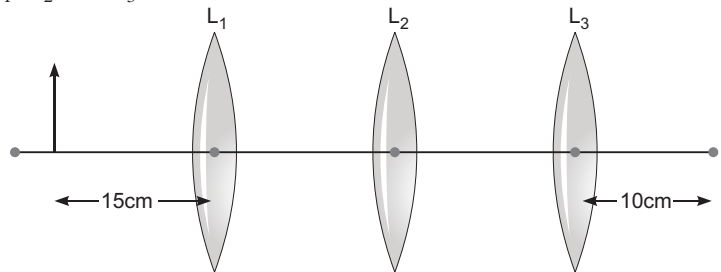
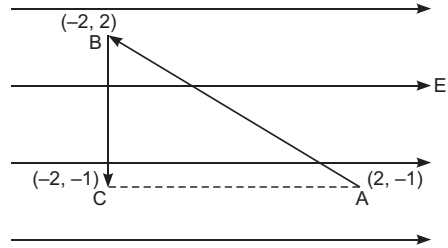

26. Calculate the value of the resistance R in the circuit shown in the figure so that the current in the circuit is 0.2 A. What would be the potential difference between points A and D?

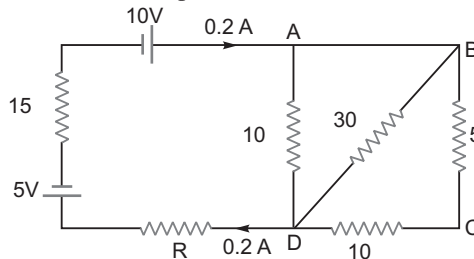

Solutions

CBSE (All India) SET-I

1. We know

$$R = \frac{l}{A};$$

For copper,

$$R_{\text{Cu}} = \rho_{\text{Cu}} \frac{l_{\text{Cu}}}{A_{\text{Cu}}} \quad \dots(i)$$

For manganin,

$$R_m = \rho_m \frac{l_m}{A_m} \quad \dots(ii)$$

But $\rho_m = \rho_{\text{Cu}}$,

and $l_m = l_{\text{Cu}}$, $R_{\text{Cu}} = R_m$

Equation (i) and equation (ii)

$$\frac{\rho_m}{\rho_{\text{Cu}}} = \frac{A_m}{A_{\text{Cu}}} = 1$$

Hence $A_m = A_{\text{Cu}}$

Manganin wire is thicker.

2. Both electric field and magnetic fields are electromagnetic waves. These waves are perpendicular to each other and perpendicular to the direction of propagation.

3. Angular separation is $\frac{D}{d} = \frac{\lambda}{d}$

Since λ is independent of D , Angular separation would remain same.

- 4.

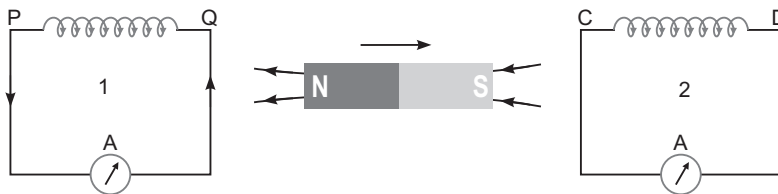

In the figure, N pole is receding away coil (1), so in coil (1), the nearer faces will act as S-pole and in coil (2) the nearer face will also act as S-pole to oppose the approach of magnet towards coil (2), so current in coils will flow clockwise as seen from the side of magnet. The direction of current will be from P to Q in coil (1) and from C to D in coil (2).

5. From Snell's law $n = \frac{\sin i}{\sin r} = \frac{c}{v}$

For given $i, v = \sin r$; r is minimum in medium A, so velocity of light is minimum in medium A.

6. We know, de Broglie wavelength

$$\frac{h}{\sqrt{2mE_k}}$$

For same *K.E.* of electron and proton.

$$\text{As } \frac{m_p}{m_e}$$

Hence wavelength of electron is greater than that of proton.

7. Two characteristic properties:

- (i) Low hysteresis loss
- (ii) Low coercivity

8. By Gauss's Theorem in electrostatics

$$= \oint E \cdot ds = \frac{q}{\epsilon_0}$$

Total flux through all six faces would be 6Φ where Φ = Flux through one face.

$$\text{Hence, } 6 \Phi = \frac{q}{\epsilon_0} \Rightarrow \Phi = \frac{q}{6 \epsilon_0}$$

9. (i) From the given diagram, potential difference between A and C

$$V_C - V_A = \int_A^C E \cdot dl \cos 180^\circ = E \times 4 = 4E$$

Hence, $V_C - V_A = 4E$

(ii) $V_C > V_A$

Because direction of electric field is in decreasing potential.

10. (i) The dipole moment of dipole is

$$|P| = q(2a)$$

Force on $-q$ at A = $-qE$

Force on $+q$ at B = $+qE$

Net force on the dipole = $qE - qE = 0$

(ii) Work done on dipole

$$W = U = PE(\cos \theta_1 - \cos \theta_2) = PE(\cos 0^\circ - \cos 180^\circ) = 2PE$$

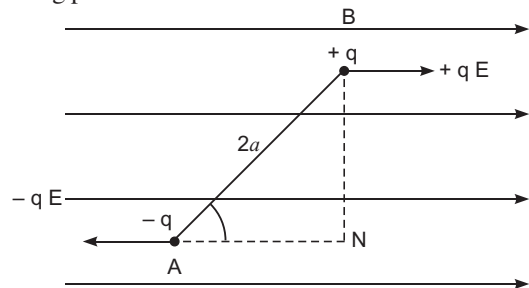

11. The principle of transformer is based upon the principle of mutual induction which states that due to continuous change in the current in the primary coil an emf gets induced across the secondary coil. At the power generating station, the step up transformers step up the output voltage which reduces the current through the cables and hence reduce resistive power loss. Then, at the consumer end, a step down transformer step down the voltage.

Hence, the large scale transmission of electric energy over long distances done with the use of transformers is taken place.

12. Yes, because of the production of displacement current between the plate of capacitor on account of changing electric field.

Current inside the capacitor

$$I_D = \epsilon_0 \frac{dE}{dt}$$

13. (i) Image formed will be inverted diminished between C and F .

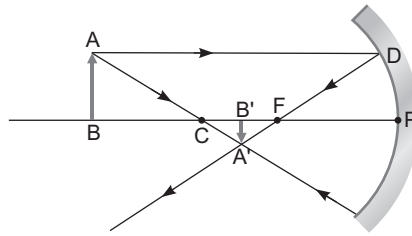

- (ii) No change in position of image and its intensity will get reduced.

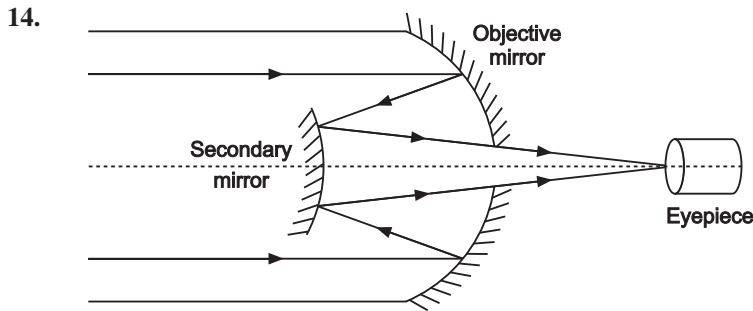

Advantages:

- (i) It is free from chromatic aberration.
 - (ii) Its resolving power is greater than refracting telescope due to larger aperture of mirror.
15. The emitter-base junction is given a small forward bias, while base collector junction is given a large reverse bias.

Under the forward biasing of emitter-base region, the positive holes of P region move towards the base. Due to thin base most of holes (about 98%) entering it pass onto collector while a very few of them (nearly 2%) combine with the electrons of base. As soon as a hole combines with the electron, a fresh electron leaves the negative terminal of battery V_{EE} and enters the base. This causes a very small base current I_B . The holes entering the collector move under the aiding reverse bias towards terminal C . As a hole reaches terminal C , an electron leaves the negative terminal of battery V_{CC} and neutralises the hole. This causes the collector current I_C . Both these currents I_B and I_C combine to form the emitter current I_e i.e.,

$$I_E = I_B + I_C$$

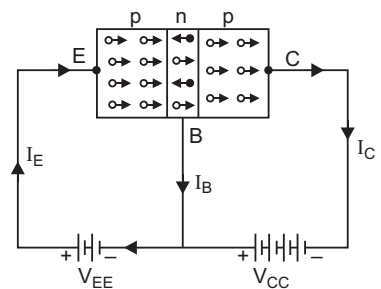

Obviously the holes are the charge carriers within the p-n-p transistor while the electrons are charge carriers in external circuit.

16.

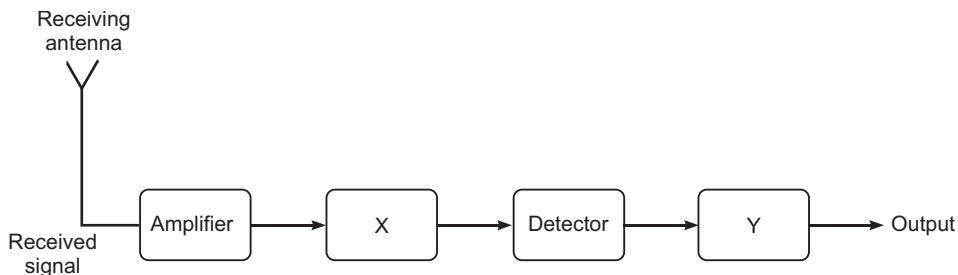

Here, X IF stage (Intermediate Frequency stage)

Its function is to change the carrier frequency to lower frequency.

Y Amplifier

Its function is to amplify the signal because the detected signal may not be strong enough to use by the user.

$$17. (a) R = \frac{V_{rms}^2}{P} = \frac{220^2}{100} = 48$$

$$(b) I_{rms} = \frac{P}{V_{rms}} = \frac{100}{220} = 0.45 \text{ A}$$

OR

$$(i) V = 140 \sin 314t$$

$$\therefore V = V_0 \sin t$$

$$\text{Hence } \frac{V_0}{\sqrt{2}} = \frac{140}{\sqrt{2}} = 98.9 \text{ V}$$

$$\frac{314}{2\pi} = 50 \text{ Hz}$$

$$(ii) V_{rms} = \frac{V_0}{\sqrt{2}} = \frac{140}{\sqrt{2}} = 98.9 \text{ V}$$

$$I = \frac{V_{rms}}{R} = \frac{98.9}{50} = 1.97 \text{ A}$$

18. As length of wire remains the same

$$N_1 \cdot 2\pi R = N_2 \cdot 2\pi \frac{R}{2}$$

$$N_2 = 2N_1$$

Magnetic moment of a coil, $m = NAI$

For the coil of radius R , magnetic moment

$$m_1 = N_1 I A_1 = N_1 I \pi R^2$$

For the coil of radius $\frac{R}{2}$, magnetic moment

$$m_2 = N_2 I A_2 = \frac{2N_1 I \pi \left(\frac{R}{2}\right)^2}{4} = \frac{N_1 I \pi R^2}{2}$$

Now, $\frac{m_2}{m_1} = 1:2$

- 19.** When a capacitor is charged by a battery, work is done by the charging battery at the expense of its chemical energy. This work is stored in the capacitor in the form of electrostatic potential energy.

Consider a capacitor of capacitance C . Initial charge on capacitor is zero. Initial potential difference between capacitor plates zero. Let a charge Q be given to it in small steps. When charge is given to capacitor, the potential difference between its plates increases. Let at any instant

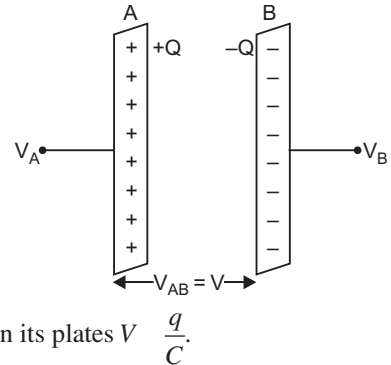

when charge on capacitor be q , the potential difference between its plates $V = \frac{q}{C}$.

Now work done in giving an additional infinitesimal charge dq to capacitor

$$dW = V dq = \frac{q}{C} dq$$

The total work done in giving charge from 0 to Q will be equal to the sum of all such infinitesimal works, which may be obtained by integration. Therefore total work

$$W = \int_0^Q V dq = \int_0^Q \frac{q}{C} dq$$

$$= \frac{1}{C} \left[\frac{q^2}{2} \right]_0^Q = \frac{1}{C} \left(\frac{Q^2}{2} - 0 \right) = \frac{Q^2}{2C}$$

If V is the final potential difference between capacitor plates, then $Q = CV$

$$W = \frac{(CV)^2}{2C} = \frac{1}{2} CV^2 = \frac{1}{2} QV$$

This work is stored as electrostatic potential energy of capacitor *i.e.*,

Electrostatic potential energy, $U = \frac{Q^2}{2C} = \frac{1}{2} CV^2 = \frac{1}{2} QV$

When battery is disconnected

(i) Energy stored will be decreased. The energy becomes, $U = \frac{Q_0^2}{2C} = \frac{Q_0^2}{2KC_0} = \frac{U_0}{K}$

Thus, energy is reduced to $\frac{1}{K}$ times the initial energy.

(ii) In the presence of dielectric the electric field is reduced to $E = \frac{E_0}{K}$.

- 20.** Here, $R_{BCD} = 5 + 10 = 15$

Effective resistance between B and E

$$\frac{1}{R_{BE}} = \frac{1}{30} + \frac{1}{10} + \frac{1}{15} \quad R_{BE} = 5$$

Applying Kirchoff's Law

$$5 \times 0.2 + R \times 0.2 + 15 \times 0.2 = 8 - 3$$

$$R = 5$$

Hence

$$V_{BE} = IR_{BE} \\ = 0.2 \times 5 = 1 \text{ volt}$$

21. Given $f_1 = f_2 = f_3 = 20 \text{ cm}$

For lens L_1

$$u_1 = -40 \text{ cm}$$

By lens formula $\frac{1}{v_1} - \frac{1}{u_1} = \frac{1}{f_1}$

$$\frac{1}{v_1} - \frac{1}{-20} = \frac{1}{-40} \quad v_1 = 40 \text{ cm}$$

For lens L_2

$$f_2 = 20 \text{ cm}, v_2 = 20 \text{ cm}, u_2 = ?$$

By lens formula, $\frac{1}{v_2} - \frac{1}{u_2} = \frac{1}{f_2}$

$$\frac{1}{20} - \frac{1}{u_2} = \frac{1}{20}$$

$$\frac{1}{u_2} = 0 \quad u_2 = \infty$$

Thus lens L_2 should produce image at infinity.

Hence, for L_2 , its objective should be at focus. The image formed by lens L_1 is at 40 cm on the right side of lens L_1 which lies at 20 cm left of lens L_2 i.e., focus of lens L_2 .

Hence, the distance between L_1 and $L_2 = 40 + 20 = 60 \text{ cm}$.

As the image formed by lens L_2 lies at infinity, then, the distance between lens L_2 and L_3 does not matter.

Hence, the distance between L_2 and L_3 can have any value.

22. (i) Cut off or stopping potential is that minimum value of negative potential at anode which just stops the photo electric current.

- (ii) For a given material, there is a minimum frequency of light below which no photo electric emission will take place, this frequency is called as threshold frequency.

By Einstein's photo electric equation

$$KE_{max} = \frac{hC}{\lambda} - h\nu_0$$

$$eV_0 = h\nu - h\nu_0$$

$$V_0 = \frac{h}{e}\nu - \frac{h}{e}\nu_0$$

Clearly, $V_0 - \nu$ graph is a straight line.

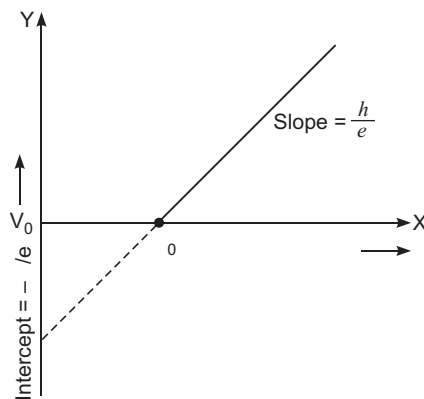

- 23. Expression for Impedance in LCR series circuit:** Suppose resistance R , inductance L and capacitance C are connected in series and an alternating source of voltage $V = V_0 \sin t$ is applied across it. (fig. a) On account of being in series, the current (i) flowing through all of them is the same.

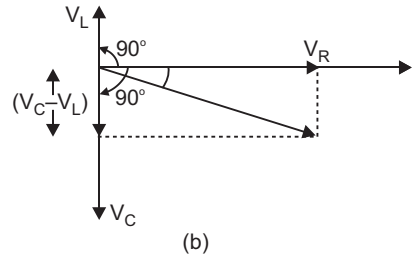
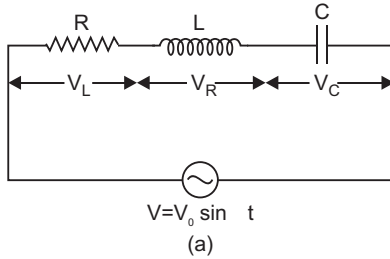

Suppose the voltage across resistance R is V_R , voltage across inductance L is V_L and voltage across capacitance C is V_C . The voltage V_R and current i are in the same phase, the voltage V_L will lead the current by angle 90° while the voltage V_C will lag behind the current by angle 90° (fig. b). Clearly V_C and V_L are in opposite directions, therefore their resultant potential difference $V_C - V_L$ (if $V_C > V_L$).

Thus V_R and $(V_C - V_L)$ are mutually perpendicular and the phase difference between them is 90° . As applied voltage across the circuit is V , the resultant of V_R and $(V_C - V_L)$ will also be V . From fig.

$$V^2 = V_R^2 + (V_C - V_L)^2 \quad V = \sqrt{V_R^2 + (V_C - V_L)^2} \quad \dots(i)$$

But $V_R = Ri, V_C = X_C i$ and $V_L = X_L i \quad \dots(ii)$

where $X_C = \frac{1}{C}$ capacitance reactance and $X_L = L$ inductive reactance

$$\text{Impedance of circuit, } Z = \frac{V}{i} = \sqrt{R^2 + (X_C - X_L)^2}$$

i.e. $Z = \sqrt{R^2 + (X_C - X_L)^2} = \sqrt{R^2 + \left(\frac{1}{C} - L\right)^2}$

$$\text{Instantaneous current } I = \frac{V_0 \sin(t)}{\sqrt{R^2 + \left(\frac{1}{C} - L\right)^2}}$$

The phase difference (ϕ) between current and voltage is given by

$$\tan \phi = \frac{X_C - X_L}{R}$$

The graph of variation of peak current i_m with frequency is shown in fig.

With increase in frequency, current first increases and then decreases. At resonant frequency, the current amplitude is maximum.

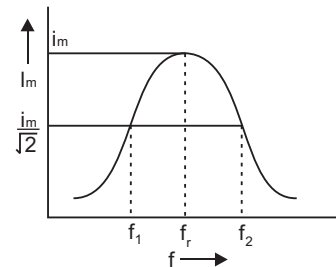

24. Three mode of propagation of electromagnetic waves:

- (i) Ground waves
- (ii) Sky waves
- (iii) Space waves

Sky wave propagation is used for long distance communication by ionospheric reflection of radio wave

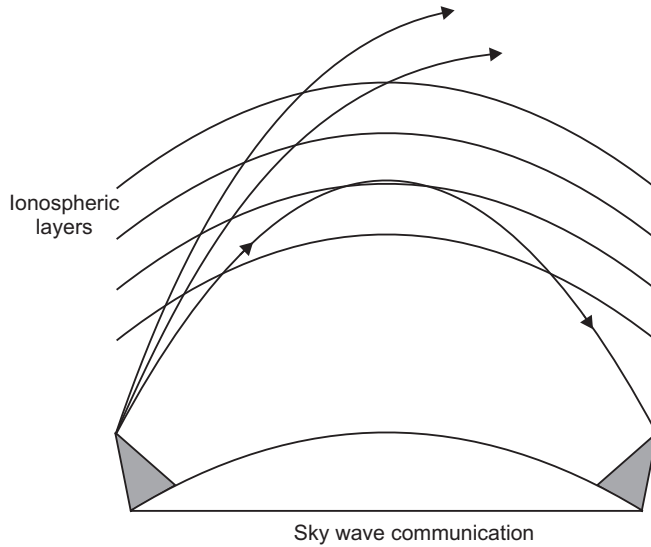

When radio waves (frequency range 3MHz – 30 MHz), emitted from the transmitting antenna, reach the receiving antenna after reflection from the ionosphere which acts as a reflector for radio waves.

25. Part *AB* represents repulsive force and Part *BCD* represents attractive force.

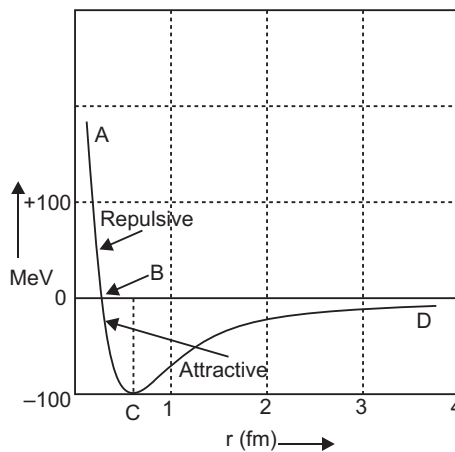

Conclusions:

- (1) Nuclear forces are attractive and stronger, than electrostatic force.
 (2) Nuclear forces are charge-independent.

- 26.** Let r_0 be the distance of closest approach where the $K.E.$ of α -particle is converted into its potential energy.

Given, $Z = 80, E_k = 8\text{MeV}$

$$K = \frac{1}{4} \frac{(Ze)(2e)}{r_0}$$

$$r_0 = \frac{1}{4} \frac{(Ze)(2e)}{K} = \frac{2Ze^2}{4K}$$

$$r_0 = \frac{9 \cdot 10^9 \cdot 2 \cdot 80 \cdot (1.6 \cdot 10^{-19})^2}{8 \cdot 10^6 \cdot (1.6 \cdot 10^{-19})}$$

$$= \frac{18 \cdot 80 \cdot 1.6 \cdot 10^{-10}}{8 \cdot 10^6} \text{ m} = 2.88 \times 10^{-14} \text{ m}$$

As $r_0 \propto \frac{1}{K}$

If kinetic energy (K) of α -particle is doubled, the distance of closest approach will become half.

OR

As we know:

$$E_n = \frac{13.6}{n^2} \text{ eV} \quad \dots(i)$$

For $n = 1, E_1 = 13.6 \text{ eV}$

When electron undergoes transitions from $E_A = 0.85\text{eV}$ to $E_B = 3.4\text{eV}$

Then, from equation (i)

$$-0.85 = \frac{13.6}{n_A^2} \quad n_A = 4$$

Similarly, $-3.4 = \frac{13.6}{n_B^2} \quad n_B = 2$

Hence electron transits from $n = 4$ to $n = 2$. It corresponds to Balmer series.

We know, $\frac{1}{\lambda} = R \left[\frac{1}{n_B^2} - \frac{1}{n_A^2} \right]$

Here, $n_A = 4, n_B = 2, R = 1.097 \cdot 10^7 \text{ m}^{-1}$

Then, $\frac{1}{\lambda} = 1.097 \cdot 10^7 \left[\frac{1}{2^2} - \frac{1}{4^2} \right] = 4862 \text{ \AA}$

- 27.** Relaxation time of free electrons drifting in a conductor is the average time elapsed between two successive collisions.

The relation between τ and v_d is

$$v_d = \frac{eE}{m}$$

Let a conductor of length 'l' and area of cross-section 'A' with electron density n. The current flowing through the conductor is

$$I = -neAv_d = neA \frac{eE}{m} = \frac{ne^2EA}{m}$$

If V is the potential difference applied across the two ends, then electric field (E) $\frac{V}{l}$

Then current becomes

$$I = \frac{nAe^2V}{ml}$$

Then,
$$\frac{V}{I} = \frac{ml}{ne^2A}$$

By Ohm's Law $R = \frac{V}{I}$

$$R = \frac{m}{ne^2} \frac{l}{A} = \frac{l}{A} \frac{m}{ne^2}$$

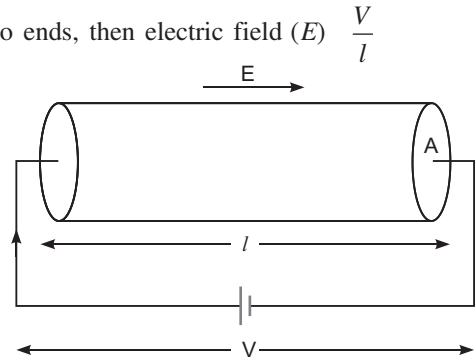

28. (a) Conditions of Constructive and Destructive Interference:

Suppose two coherent waves travel in the same direction along a straight line, the frequency of each wave is $\frac{\omega}{2\pi}$ and amplitudes of electric field are a_1 and a_2 respectively. If at any time t , the electric fields of waves at a point are y_1 and y_2 respectively and phase difference is ϕ , then equation of waves may be expressed as

$$y_1 = a_1 \sin(\omega t) \quad \dots(i)$$

$$y_2 = a_2 \sin(\omega t + \phi) \quad \dots(ii)$$

According to Young's principle of superposition, the resultant displacement at that point will be

$$y = y_1 + y_2 \quad \dots(iii)$$

Substituting values of y_1 and y_2 from (i) and (ii) in (iii), we get

$$y = a_1 \sin(\omega t) + a_2 \sin(\omega t + \phi)$$

Using trigonometric relation

$$\sin(\omega t + \phi) = \sin \omega t \cos \phi + \cos \omega t \sin \phi,$$

we get $y = a_1 \sin \omega t + a_2 (\sin \omega t \cos \phi + \cos \omega t \sin \phi)$

$$(a_1 + a_2 \cos \phi) \sin \omega t + (a_2 \sin \phi) \cos \omega t \quad \dots(iv)$$

Let $a_1 + a_2 \cos \phi = A \cos \alpha$... (v)

and $a_2 \sin t + A \sin t$...*(vi)*

where A and ϕ are new constants.

Then equation *(iv)* gives $y = A \cos t + A \sin t = A \sin(t + \phi)$...*(vii)*

This is the equation of the resultant disturbance. Clearly the amplitude of resultant disturbance is A and phase difference from first wave is ϕ . The values of A and ϕ are determined by *(v)* and *(vi)*. Squaring *(v)* and *(vi)* and then adding, we get

$$(a_1 + a_2 \cos \phi)^2 + (a_2 \sin \phi)^2 = A^2 \cos^2 \phi + A^2 \sin^2 \phi$$

or $a_1^2 + a_2^2 \cos^2 \phi + 2a_1a_2 \cos \phi + a_2^2 \sin^2 \phi = A^2 (\cos^2 \phi + \sin^2 \phi)$

As $\cos^2 \phi + \sin^2 \phi = 1$, we get

$$A^2 = a_1^2 + a_2^2 + 2a_1a_2 \cos \phi$$

or $A^2 = a_1^2 + a_2^2 + 2a_1a_2 \cos \phi$

$$\text{Amplitude, } A = \sqrt{a_1^2 + a_2^2 + 2a_1a_2 \cos \phi} \quad \dots\text{(viii)}$$

As the intensity of a wave is proportional to its amplitude in arbitrary units $I \propto A^2$

Intensity of resultant wave

$$I = A^2 = a_1^2 + a_2^2 + 2a_1a_2 \cos \phi \quad \dots\text{(ix)}$$

Clearly the intensity of resultant wave at any point depends on the amplitudes of individual waves and the phase difference between the waves at the point.

Constructive Interference : For maximum intensity at any point $\cos \phi = 1$

or phase difference, $0, 2\pi, 4\pi, 6\pi, \dots$

$$2n\pi \quad (n = 0, 1, 2, \dots) \quad \dots\text{(x)}$$

The maximum intensity,

$$I_{\max} = a_1^2 + a_2^2 + 2a_1a_2 = (a_1 + a_2)^2 \quad \dots\text{(xi)}$$

Path difference $\frac{\lambda}{2}$ Phase difference $\frac{2\pi}{\lambda} \times \frac{\lambda}{2} = \pi$ n $\dots\text{(xii)}$

Clearly the maximum intensity is obtained in the region of superposition at those points where waves meet in the same phase or the phase difference between the waves is even multiple of π or path difference between them is the integral multiple of $\frac{\lambda}{2}$ and maximum intensity is $(a_1 + a_2)^2$ which is greater than the sum intensities of individual waves by an amount $2a_1a_2$.

Destructive Interference : For minimum intensity at any point $\cos \phi = -1$

or phase difference, $\pi, 3\pi, 5\pi, 7\pi, \dots$

$$(2n + 1)\pi, \quad n = 1, 2, 3, \dots \quad \dots\text{(xiii)}$$

In this case the minimum intensity,

$$I_{\min} = a_1^2 + a_2^2 - 2a_1a_2 = (a_1 - a_2)^2 \quad \dots\text{(xiv)}$$

Path difference,

$$\frac{\pi}{2} \text{ Phase difference}$$

$$\frac{\pi}{2} (2n + 1) \quad (2n + 1) \frac{\pi}{2} \quad \dots(xv)$$

Clearly, the minimum intensity is obtained in the region of superposition at those points where waves meet in opposite phase or the phase difference between the waves is odd multiple of $\frac{\pi}{2}$ or path difference between the waves is odd multiple of $\frac{\lambda}{2}$ and minimum intensity $(a_1 - a_2)^2$ which is less than the sum of intensities of the individual waves by an amount $2a_1a_2$.

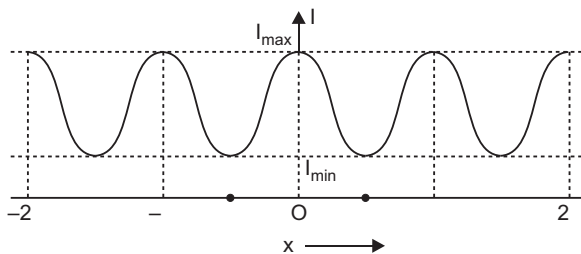

From equations (xii) and (xvi) it is clear that the intensity $2a_1a_2$ is transferred from positions of minima to maxima. This implies that the **interference is based on conservation of energy**.

Variation of Intensity of light with position x is shown in fig.

(b) Given $\lambda_1 = 800 \text{ nm} = 800 \times 10^{-9} \text{ m}$

$\lambda_2 = 600 \text{ nm} = 600 \times 10^{-9} \text{ m}$

$D = 1.4 \text{ m}$

$d = 0.28 \text{ mm} = 0.28 \times 10^{-3} \text{ m}$

For least distance of coincidence of fringes, there must be a difference of 1 in order of λ_1 and λ_2 .

As $n_1 \lambda_1 = n_2 \lambda_2$,

If $n_1 = n$, $n_2 = n + 1$

$$y_{n+1} = (y_n + 1) \lambda_2$$

$$\frac{nD}{d} \lambda_1 = \frac{(n + 1)D}{d} \lambda_2$$

$$n \lambda_1 = (n + 1) \lambda_2$$

$$n \frac{\lambda_1}{\lambda_2} = \frac{(n + 1) \lambda_2}{\lambda_1} = \frac{600}{800} = \frac{3}{4}$$

$$y_{\min} = \frac{nD}{d} \lambda_1$$

$$= \frac{3 \times 1.4 \times 800 \times 10^{-9}}{0.28 \times 10^{-3}}$$

$$= 12000 \times 10^{-6}$$

$$= 12 \times 10^{-3} \text{ m}$$

OR

- (a) A polaroid consists of long chain molecules aligned in a particular direction. The electric vectors along the direction of the aligned molecules get absorbed. So, when an unpolarised light falls on a polaroid, it lets only those of its electric vectors that are oscillating along a direction perpendicular to its aligned molecules to pass through it. The incident light thus gets linearly polarised.

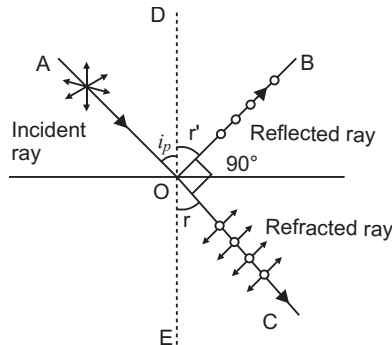

Whenever unpolarised light is incident on the boundary between two transparent media, the reflected light gets partially or completely polarised. When reflected light is perpendicular to the refracted light, the reflected light is a completely polarised light.

- (b) Let the angle between the pass axis of A and C =

$$\text{Intensity of light passing through A} = \frac{I_0}{2}$$

$$\text{Intensity of light passing through C} = \frac{I_0}{2} \cos^2$$

$$\begin{aligned} \text{Intensity of light passing through B} &= \frac{I_0}{2} \cos^2 \cdot \cos^2(90^\circ) \\ &= \frac{I_0}{2} \cos^2 \cdot \sin^2 = \frac{I_0}{2} (\cos \cdot \sin)^2 \end{aligned}$$

According to question

$$\frac{I_0}{2} (\cos \sin)^2 = \frac{I_0}{8}$$

$$\frac{I_0}{2} \frac{2 \sin \cos}{2}^2 = \frac{I_0}{8}$$

$$\sin 2 = 1$$

$$\text{or, } 2 = 90 \quad = 45^\circ$$

The third polaroid is placed at 45° .

29. (a) Two important processes occur during the formation of a p - n junction are (i) diffusion and (ii) drift.

(i) **Diffusion:** In n -type semiconductor, the concentration of electrons is much greater as compared to concentration of holes; while in p -type semiconductor, the concentration of holes is much greater than the concentration of electrons. When a p - n junction is formed, then due to concentration gradient, the holes diffuse from p side to n side ($p \rightarrow n$) and electrons diffuse from n side to p -side ($n \rightarrow p$). This motion of charge carriers gives rise to diffusion current across the junction.

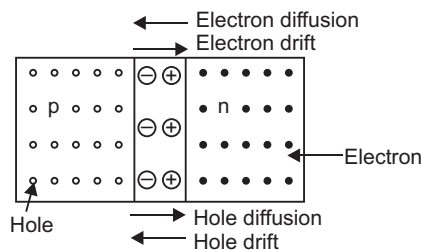

(ii) **Drift:** The drift of charge carriers occurs due to electric field. Due to built in potential barrier an electric field directed from n -region to p -region is developed across the junction. This field causes motion of electrons on p -side of the junction to n -side and motion of holes on n -side of junction to p -side. Thus a drift current starts. This current is opposite to the direction of **diffusion current**.

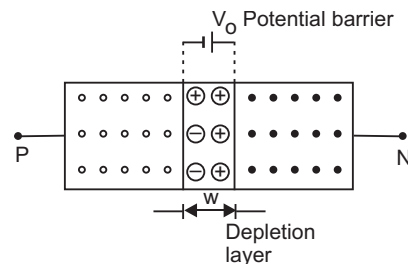

- (b) Zener diode is used as voltage regulator.

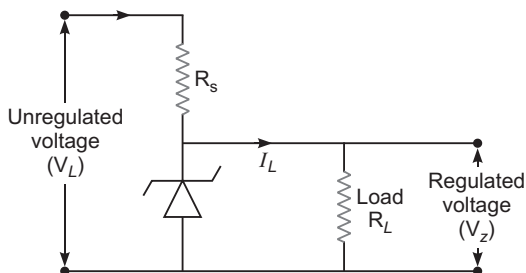

Any increase/decrease in the input voltage results in increase/decrease of the voltage drop across R_s without any change in voltage across the zener diode. Thus, the zener diode acts as a voltage regulator.

OR

- (a) **A transistor as an Oscillator:**

The circuit of a tuned collector in CE configuration is shown in figure.

The circuit contains tuned circuit made of variable capacitor C and an inductor L in the collector circuit and hence is named as tuned *collector oscillator*.

The feed back coil L connected to base circuit is mutually coupled with coil L (due to phenomenon of mutual induction); the mutual inductance of L and L being M . In practice L and L form the primary and secondary coil of the transformer.

The biasing is provided by emitter resistance R_E and potential divider arrangement consisting of resistances R_1 and R_2 . The capacitor C_1 connected in the base circuit provides low reactance path to the oscillations and the capacitor C_E is the emitter by-pass capacitor so that the resistor R_E has no effect on the ac operation of the circuit.

Circuit Operation. When the collector supply voltage is switched on by closing switch S , collector current starts increasing and the capacitor C is charged. When the capacitor attains maximum charge, it discharges through coil L , setting up oscillations of natural frequency.

$$f = \frac{1}{2\sqrt{LC}}$$

These oscillations induce a small voltage in coil L by mutual induction. This induced voltage is the feed back voltage; its frequency is same as that of resonant LC circuit but its magnitude depends on the number of turns in L and coupling between L and L . The feedback voltage is applied between the base and emitter and appears in the amplified form in the collector circuit. A part of this amplifier energy is used to meet losses taking place in oscillatory circuit to maintain oscillations in tank circuit and the balance is radiated out in the form of electromagnetic waves.

Positive Feed back. The feed back applied in tuned collector oscillator circuit is positive. This may be seen as follows: A phase shift of 180° is created between the voltages of L and L due to transformer action. A further phase shift of 180° arises between base-emitter and collector circuit due to transistor action in CE configuration. Thus the net phase becomes 360° (or zero); which is the required condition for a positive feed back. Due to positive feed back the energy fed back to the tank circuit is in phase with the generated oscillations, thus maintaining oscillations.

(b) Output $y = \overline{\overline{A} \cdot \overline{\overline{B}}} = \overline{\overline{A} \cdot \overline{B}} = A \cdot B$

The equivalent gate for the given circuit is AND gate

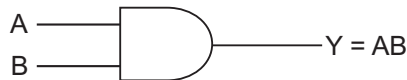

Truth table

A	B	Y
0	0	0
0	1	0
1	0	0
1	1	1

30. (a) Electric force on particle, $F_e = qE$

Magnetic force on particle, $F_m = q(v \times B)$

Total force, $F = F_e + F_m$

$$F = q(E + v \times B)$$

If a charge particle enters perpendicular to both the electric and magnetic fields then it may happen that the electric and magnetic forces cancel each other and so the particle will pass undeflected.

In such a case, $F = 0$

$$q(E - v \times B) = 0 \quad E = (v \times B)$$

$$E = B \times v$$

$$E = Bv \sin 90^\circ = Bv \text{ (when } 90^\circ \text{)}$$

$$v = \frac{E}{B} \text{ (when } v, E \text{ and } B \text{ are mutually perpendicular)}$$

(b) **Torque on a current carrying loop:** Consider a rectangular loop PQRS of length l , breadth b

suspended in a uniform magnetic field \mathbf{B} . The length of loop PQ , $RS = l$ and breadth QR , $SP = b$. Let at any instant the normal to the plane of loop make an angle θ with the

direction of magnetic field \mathbf{B} and I be the current in the loop. We know that a force acts on a current carrying wire placed in a magnetic field. Therefore, each side of the loop will experience a force. The net force and torque acting on the loop will be determined by the forces acting on all sides of the loop. Suppose that the forces on sides PQ , QR , RS and SP are

\mathbf{F}_1 , \mathbf{F}_2 , \mathbf{F}_3 and \mathbf{F}_4 respectively. The sides QR and SP make angle $(90^\circ - \theta)$ with the direction of magnetic field. Therefore each of the forces

\mathbf{F}_2 and \mathbf{F}_4 acting on these sides has same magnitude $F = B l b \sin (90^\circ - \theta) = B l b \cos \theta$.

According to Fleming's left hand rule the forces \mathbf{F}_2 and \mathbf{F}_4 are equal and opposite but their line of action is same. Therefore these forces cancel each other i.e. the resultant of \mathbf{F}_2 and \mathbf{F}_4 is zero.

The sides PQ and RS of current loop are perpendicular to the magnetic field, therefore the magnitude of each of forces \mathbf{F}_1 and \mathbf{F}_3 is

$$F = I l B \sin 90^\circ = I l B.$$

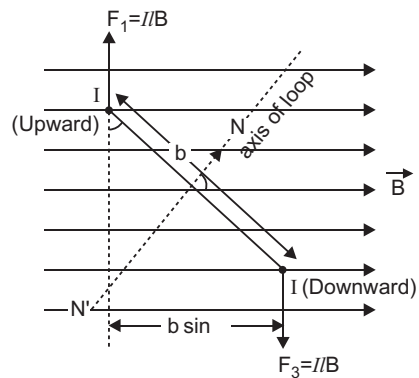
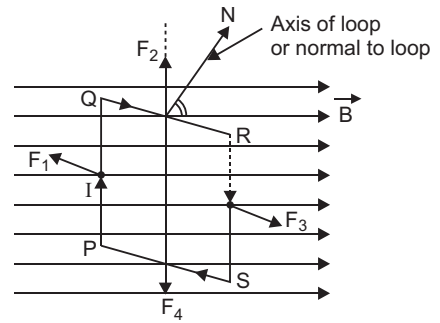

According to Fleming’s left hand rule the forces F_1 and F_3 acting on sides PQ and RS are equal and opposite, but their lines of action are different; therefore the resultant force of

F_1 and F_3 is zero, but they form a couple called the *deflecting couple*. When the normal to plane of loop makes an angle with the direction of magnetic field B , the perpendicular distance between F_1 and F_3 is $b \sin$.

Moment of couple or Torque,

(Magnitude of one force F) perpendicular distance (BIl) $(b \sin) I (lb) B \sin$

But lb area of loop A (say)

Torque, $IAB \sin$

If the loop contains N -turns, then $NI AB \sin$

In vector form $NI A B$.

The magnetic dipole moment of rectangular current loop $= M = NIA$

$$M \perp B$$

Direction of torque is perpendicular to direction of area of loop as well as the direction of magnetic field *i.e.*, along $I A \perp B$.

OR

(a) Conversion of Galvanometer into Ammeter

A galvanometer may be converted into ammeter by using very small resistance in parallel with the galvanometer coil. The small resistance connected in parallel is called a **shunt**. If G is resistance of galvanometer, I_g is current in galvanometer for full scale deflection, then for conversion of galvanometer into ammeter of range I ampere, the shunt is given by

$$S = \frac{I_g}{I - I_g} G$$

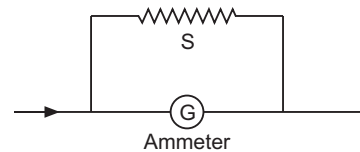

Conversion of Galvanometer into Voltmeter

A galvanometer may be converted into voltmeter by connecting high resistance (R) in series with the coil of galvanometer. If V volt is the range of voltmeter formed, then series resistance

$$R = \frac{V}{I_g} - G$$

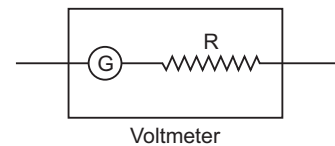

(b) The magnetic field produced by current I_1 at any point on conductor RS is

$$B_1 = \frac{\mu_0 I}{2d}$$

This field acts perpendicular to the conductor RS and points into the plane of paper. It exerts a force on RS . The force acting on length l of the conductor RS will be

$$F_{21} = I_2 l B_1 \sin 90^\circ$$

Similarly, an equal force is exerted on the wire PQ by the field of conductor RS .

$$F_{12} = \frac{\mu_0 I_1 I_2}{2d} l$$

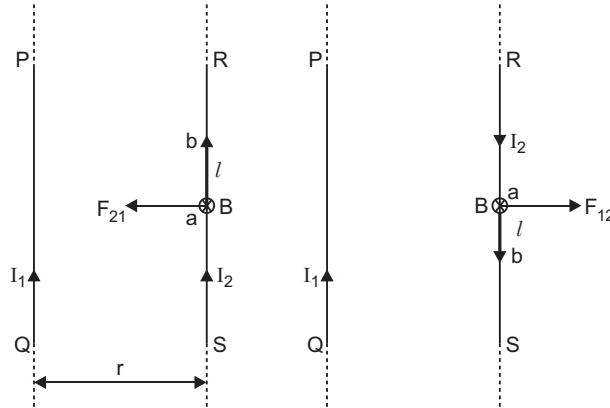

Thus, when the currents in the two conductor are in the same direction, the force between them are attractive. When the currents flow in opposite directions, the forces between the two conductors are repulsive.

CBSE (All India) Set-II

2. By symmetry, the flux through each of the six faces of the cube will be same when charge q is placed at its centre.

$$E = \frac{1}{6} \cdot \frac{q}{\epsilon_0}$$

Thus, electric flux passing through two opposite faces of the cube = $2 \cdot \frac{1}{6} \cdot \frac{q}{\epsilon_0}$

5. de Broglie wavelength (λ) is given as

$$\frac{h}{mv}$$

Given v_p v_e

where v_p = velocity of proton

v_e = velocity of electron

Since $m_p > m_e$

From the given relation

$$\frac{1}{m}, \text{ hence } \lambda_p < \lambda_e$$

Thus, electron has greater de Broglie wavelength, if accelerated with same speed.

8. In single slit diffraction experiment fringe width is

$$\frac{2 D}{d}$$

If d is doubled, the width of central maxima is halved. Thus size of central maxima is reduced to half. Intensity of diffraction pattern varies square of slit width. So, when the slit gets double, it makes the intensity four times.

Thus electron has greater de Broglie wavelength, if accelerated with same speed.

11. (i) As, work done is independent of path followed, therefore, we may directly move from A to C
 $V_C - V_A =$ Potential difference between A and C.

$$= \int_A^C E \cdot dl = \int_A^C E dl \cos 180^\circ = -E \int_A^C dl = -E \cdot 4d = -4Ed$$

Hence, $V_C - V_A = 4Ed$

- (ii) The direction of electric field is always towards the decreasing potential. Hence, electric potential at C would be more $V_C > V_A$.

16. (i) $P = 200 \text{ W}$, $V_{\text{rms}} = 220 \text{ V}$, $F = 50 \text{ Hz}$

We know

$$P = \frac{V_{\text{rms}}^2}{R} \quad \text{or} \quad R = \frac{V_{\text{rms}}^2}{P} = \frac{220^2}{200} = 242 \Omega$$

(ii) $P = I_{\text{rms}} V_{\text{rms}}$
 $I_{\text{rms}} = \frac{P}{V_{\text{rms}}} = \frac{200}{220} = 0.909 \text{ A}$

OR

Given $V = 280 \sin 50\pi t$

(a) Here, $V_0 = 280 \text{ V}$, $f = 50 \text{ Hz}$

(b) $V_{\text{rms}} = \frac{V_0}{\sqrt{2}} = \frac{280}{\sqrt{2}} = 197.99 \text{ V}$

$$I_{\text{rms}} = \frac{V_{\text{rms}}}{R} = \frac{197.99 \text{ V}}{40 \Omega} = 4.95 \text{ A}$$

17. We know,

magnetic moment (m) = NIA

where N = No. of turns

Then, length of wire remains same

Thus, $N \cdot 2 \cdot \frac{d}{2} = N' \cdot 2 \cdot \frac{2d}{2}$

$$N = \frac{N'}{2}$$

Now, $m_A = NIA_A = NI \left(\frac{d}{2}\right)^2 = \frac{1}{4} NI d^2$

Similarly $m_B = N' I A_B = \frac{N'}{2} I \left(\frac{2d}{2}\right)^2 = \frac{1}{2} (NI d^2)$

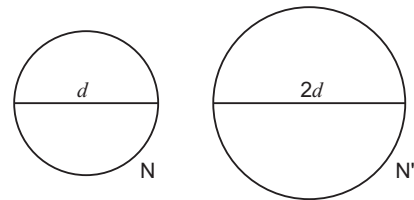

$$\frac{m_B}{m_A} = \frac{\frac{1}{2}}{\frac{1}{4}} = \frac{2}{1} \qquad \frac{m_B}{m_A} = \frac{2}{1}$$

19. Given $f_1 = f_2 = f_3 = 15\text{ cm}$

We have, lens formula

$$\frac{1}{v_1} - \frac{1}{u_1} = \frac{1}{f_1} \qquad u_1 = -20\text{ cm}, f_1 = 15\text{ cm}$$

$$\frac{1}{v_1} - \frac{1}{-20} = \frac{1}{15} \qquad v_1 = 60\text{ cm}$$

So, the image formed by lens L_2 is at infinity.

It means that the object for L_2 lies at its focus.

So, $u_2 = 15\text{ cm}$

Hence, distance between L_1 and L_2 is

$$d_1 = v_1 + u_2 = 60 + 15 = 75\text{ cm}$$

As the image formed by lens L_2 lies at infinity then, the distance between L_2 and L_3 does not matter. Hence, the distance between L_2 and L_3 can have any value.

23. The equivalent diagram of given electric circuit is

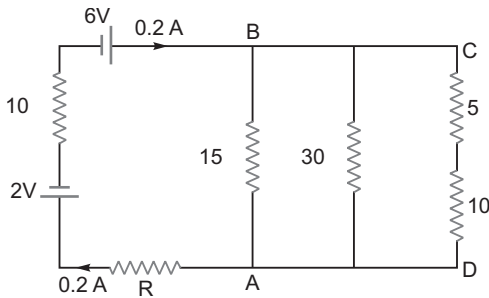

Effective resistance between A and B

$$\frac{1}{R} = \frac{1}{10} + \frac{1}{30} + \frac{1}{15} \qquad R = 5$$

Applying Kirchoff's Law

$$5 \times 0.2 + R(0.2) + 10(0.2) = 6 - 2$$

$$R = 5$$

When $R =$ unknown value of resistance

$$V_{AB} = 5 \times 0.2 = 1\text{ volt}$$

27. Let r_0 be the distance of closest approach where the $K.E$ of α -particle is converted into its potential energy.

Given $Z = 75, E_k = 5\text{ MeV}$

$$E_k = \frac{1}{4\pi\epsilon_0} \frac{(2e)(Ze)}{r}$$

$$\text{or } r_0 = \frac{1}{4} \frac{(2e)(Ze)}{E_k}$$

$$r_0 = \frac{9 \times 10^9 \times 75 \times 2 \times (1.6 \times 10^{-19})^2}{5 \times 10^6 \times 1.6 \times 10^{-19}} = \frac{18 \times 75 \times 1.6 \times 10^{10}}{8 \times 10^6} = 2.7 \times 10^{-14} \text{ m}$$

$$\text{As } r_0 = \frac{1}{E_k}$$

Hence, the distance of closest approach is halved if $K.E$ is doubled.

OR

$$\text{As we know, } E_n = \frac{13.6}{n^2} eV \quad \dots(i)$$

For $n = 1$, $E_1 = 13.6 eV$

When electron undergoes transition from $E_A = 0.85 eV$

Then, from equation (i)

$$-0.85 = \frac{13.6}{n_A^2} \quad n_A = 4$$

$$\text{Similarly, } -1.51 = \frac{13.6}{n_B^2} \quad n_B = 3$$

Hence, electron transits from $n = 4$ to $n = 3$ which corresponds to Paschen series of hydrogen atom.

We know

$$\frac{1}{\lambda} = R \left(\frac{1}{n_B^2} - \frac{1}{n_A^2} \right)$$

Here $n_A = 4$, $n_B = 3$, $R = 1.0974 \times 10^7 \text{ m}^{-1}$

$$\text{Then } \frac{1}{\lambda} = 1.097 \times 10^7 \left(\frac{1}{3^2} - \frac{1}{4^2} \right)$$

$$= 1875 \text{ nm}$$

CBSE (All India) Set-III

1. The fringe width is

$$\frac{D}{d}$$

If D (distance between slits and screen) is doubled, then fringe width will be doubled.

3. The total flux passing through the cube is

$$\frac{q}{\epsilon_0}$$

4. The frequency of electromagnetic waves does not change while travelling through a medium.

9. The magnetic field at the centre due a circular coil of N turns and radius r carrying current I is

$$B = \frac{\mu_0 NI}{2r}$$

The magnetic moment of the coil is

$$m = NIA = NI \pi r^2$$

10. The given transistor is $p-n-p$ transistor. The emitter is reverse biased and the collector is forward biased.

Action of $n-p-n$ transistor

An NPN transistor is equivalent to two $P-N$ junction diodes placed back to back with their very thin P -regions connected together. The circuit diagram for the operation of NPN transistor is shown in fig. The two batteries V_{EE} and V_{CC} represent emitter supply and collector supply respectively. *The emitter-base junction is forward biased and the base-collector junction is reverse biased.* Consequently the internal potential barrier at emitter-base junction neutralises while the width of depletion layer at collector-base junction increases.

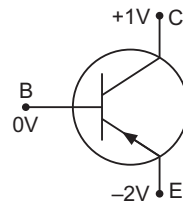

Base Current and Collector Current: Under forward bias of emitter-base junction, the electrons in emitter and holes in base are compelled to move towards the junction, thus the depletion layer of emitter-base junction is eliminated. As the base region is very thin, most electrons (about 98%) starting from emitter region cross the base region and reach the collector while only a few of them (about 2%) combine with an equal number of holes of base-region and get neutralised. As soon as a hole (in P -region) combines with an electron, a covalent bond of crystal atom of base region breaks releasing an electron-hole pair. The electron released is attracted by positive terminal of emitter battery V_{EE} , giving rise to a feeble base current (I_B). Its direction in external circuit is from emitter to base. The hole released in the base region compensates the loss of hole neutralised by electrons.

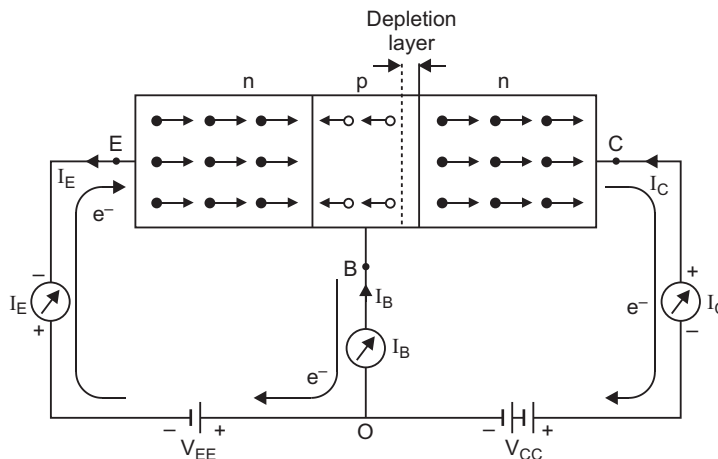

The electrons crossing the base and entering the collector, due to reverse biasing of collector-base junction, are attracted towards the positive terminal of collector battery V_{CC} . In the process an equal number of electrons leave the negative terminal of battery V_{CC} and enter the positive terminal of battery V_{EE} . This causes a current in collector circuit, called the collector current. In

addition to this the collector current is also due to flow of minority charge carriers under reverse bias of base-collector junction. This current is called the leakage current.

Thus, collector current is formed of two components:

(i) Current (I_{nc}) due to flow of electrons (majority charge carriers) moving from emitter to collector.

(ii) leakage current ($I_{leakage}$) due to minority charge carriers, i.e., $I_c = I_{nc} + I_{leakage}$.

Emitter Current: When electrons enter the emitter battery V_{EE} from the base causing base current or electrons enter the collector battery V_{CC} from the collector causing collector current, an equal number of electrons enter from emitter battery V_{EE} to emitter, causing the emitter current. The process continues.

Relation between Emitter, Base and Collector Currents:

Applying Kirchoff's I law at terminal O , we get

$$I_E = I_B + I_C$$

That is, the emitter current I_E is the sum of base current I_B and the collector current I_C . This is the fundamental relation between currents in the bipolar transistor circuit.

12. (i) $P = 150 \text{ W}$, $V_{rms} = 220 \text{ V}$, $f = 60 \text{ Hz}$

$$\text{We have } P = \frac{V_{rms}^2}{R} \quad R = \frac{V_{rms}^2}{P}$$

$$R = \frac{220^2}{150} = 322.6$$

$$(ii) P = I_{rms} V_{rms} \quad I_{rms} = \frac{P}{V_{rms}}$$

$$I_{rms} = \frac{150}{220} = 0.68 \text{ A}$$

OR

We know, $V = V_0 \sin \omega t$

Given $V = 70 \sin 100 \pi t$

$$(a) V_0 = 70 \text{ volt}, \quad \omega = 100$$

$$2\pi f = 100 \quad [\because \omega = 2\pi f]$$

$$f = 50 \text{ Hz}$$

$$(b) V_{rms} = \frac{V_0}{\sqrt{2}} = \frac{70}{\sqrt{2}}$$

$$I_{rms} = \frac{V_{rms}}{R} = \frac{70/\sqrt{2}}{25} \quad [\text{where } R = 25 \Omega]$$

$$= \frac{70}{25\sqrt{2}} = 1.98 \text{ A}$$

16. (i) From the given diagram,
potential difference between A and C

$$V_C - V_A = \int_A^C E \cdot dl = \int_A^C E dl \cos 180^\circ = -E \int_A^C dl = -E \cdot AC = -4E$$

So, $V_C - V_A = 4E$

- (ii) The direction of electric field is in the decreasing potential. Hence, the electric potential will be more at C.

Hence, $V_C > V_A$

20. (i) **Transducer:** Any device which converts one form of energy into another.
(ii) **Repeater:** It is a combination of a receiver and a transmitter. A repeater, picks up the signal from the transmitter, amplifies and retransmits it to receiver sometimes with a change in carrier frequency.
(iii) **Amplification:** It is the process of increasing the amplitude of a signal using an electronic circuit. (i.e., amplifier). It is necessary to compensate for attenuation of signal in communication system.

22. Given $f_1 = f_2 = f_3 = 10 \text{ cm}$, $u_1 = -15 \text{ cm}$

By lens formula $\frac{1}{v_1} - \frac{1}{u_1} = \frac{1}{f_1}$

$$\frac{1}{v_1} - \frac{1}{-15} = \frac{1}{10} \Rightarrow \frac{1}{v_1} = \frac{1}{10} - \frac{1}{15} = \frac{3 - 2}{30} = \frac{1}{30}$$

$$v_1 = 30 \text{ cm}$$

Since, final image is formed by lens L_3 at focus. Hence, for L_3 , the object must be at infinity. Thus lens L_2 should produce image at infinity. So for L_2 , its object should be at focus.

The image formed by lens L_1 is at 15 cm on the right side of lens L_1 which lies at 10 cm left of lens L_2 , i.e., focus of lens L_2 .

Hence, distance between L_1 and $L_2 = 30 \text{ cm} + 10 \text{ cm} = 40 \text{ cm}$

As the image formed by Lens L_2 lies at infinity. Then, the distance between lens L_2 and L_3 does not matter.

Hence, the distance between L_2 and L_3 can have any value.

26. The equivalent diagram of the given electrical circuit is as follows.

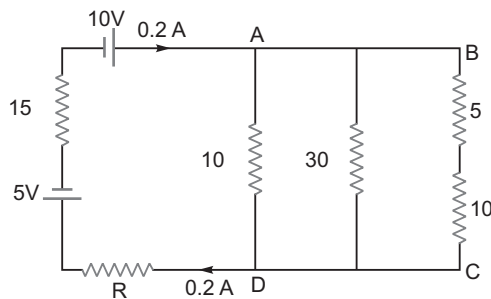

The effective resistance between A and D

$$\frac{1}{R} = \frac{1}{10} + \frac{1}{30} + \frac{1}{15} = \frac{3 + 1 + 2}{30}$$

$$R = 5$$

Applying Kirchhoff Law, to find unknown R .

$$5 \times 0.2 + R \times 0.2 + 15 \times 0.2 = +10 - 5$$

$$1 + \frac{R}{5} = 3 \quad R = 5$$

Hence $V_{AD} = 5 \times 0.2 = 1$ volt

CBSE EXAMINATION PAPERS

FOREIGN-2012

Time allowed: 3 hours

Maximum marks: 70

General Instructions: As given in CBSE Examination Papers Delhi-2011.

CBSE (Foreign) Set-I

1. Why is the potential inside a hollow spherical charged conductor constant and has the same value as on its surface?
2. A magnetic needle, free to rotate in a vertical plane, orients itself vertically at a certain place on the Earth. What are the values of (i) horizontal component of Earth's magnetic field and (ii) angle of dip at this place?
3. The closed loop (PQRS) of wire is moved into a uniform magnetic field at right angles to the plane of the paper as shown in the figure. Predict the direction of the induced current in the loop.
4. Name the electromagnetic waves, which (i) maintain the Earth's warmth and (ii) are used in aircraft navigation.
5. How does focal length of a lens change when red light incident on it is replaced by violet light? Give reason for your answer.
6. Write the relationship between the size of a nucleus and its mass number (A).
7. Show on a graph the variation of the de Broglie wavelength (λ) associated with an electron, with the square root of accelerating potential (V).
8. Define dipole moment of an electric dipole. Is it a scalar or a vector?
9. A conductor of length ' l ' is connected to a dc source of potential ' V '. If the length of the conductor is tripled by gradually stretching it, keeping ' V ' constant, how will (i) drift speed of electrons and (ii) resistance of the conductor be affected? Justify your answer.

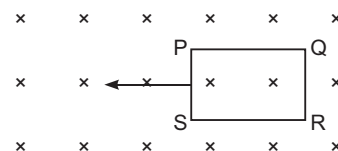

10. Two students 'X' and 'Y' perform an experiment on potentiometer separately using the circuit given:

Keeping other parameters unchanged, how will the position of the null point be affected it

- (i) 'X' increases the value of resistance R in the set-up by keeping the key K_1 closed and the key K_2 open?
- (ii) 'Y' decreases the value of resistance S in the set-up, while the key K_2 remain open and the key K_1 closed?

Justify.

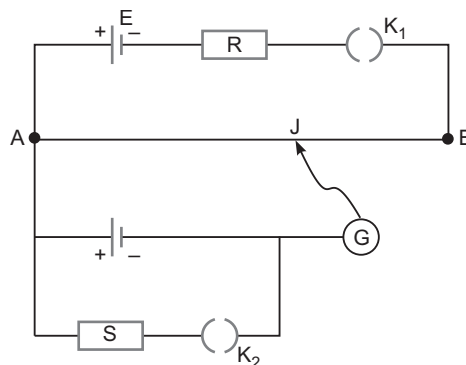

11. A particle of charge ' q ' and mass ' m ' is moving with velocity V . It is subjected to a uniform magnetic field B directed perpendicular to its velocity. Show that it describes a circular path. Write the expression for its radius.
12. Calculate the quality factor of a series LCR circuit with $L = 2.0$ H, $C = 2$ F and $R = 10$. Mention the significance of quality factor in LCR circuit.
13. Explain briefly how electromagnetic waves are produced by an oscillating charge. How is the frequency of the em waves produced related to that of the oscillating charge?
14. In a given sample, two radioisotopes, A and B , are initially present in the ratio of 1:4. The half lives of A and B are respectively 100 years and 50 years. Find the time after which the amounts of A and B become equal.
15. Figure shows a block diagram of a transmitter. Identify the boxes ' X ' and ' Y ' and write the their functions.

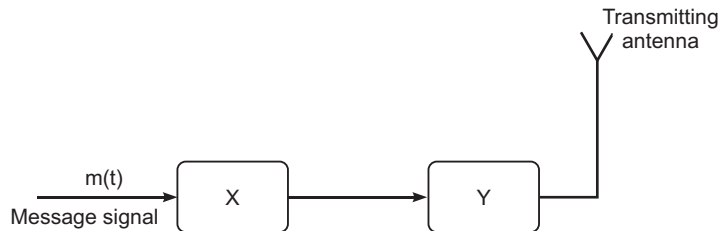

16. Trace the path of a ray of light passing through a glass prism (ABC) as shown in the figure. If the refractive index of glass is $\sqrt{3}$, find out of the value of the angle of emergence from the prism.

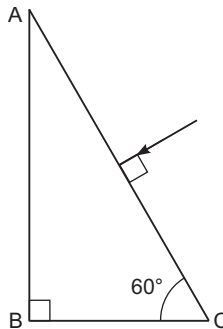

17. Write two characteristic features to distinguish between n -type and p -type semiconductors.

OR

How does a light emitting diode (LED) work? Give two advantages of LED's over the conventional incandescent lamps.

18. A short bar magnet of magnetic moment 0.9 J/T is placed with its axis at 30° to a uniform magnetic field. It experiences a torque of 0.063 J.
 - (i) Calculate the magnitude of the magnetic field.
 - (ii) In which orientation will the bar magnet be in stable equilibrium in the magnetic field?
19. State Gauss's law in electrostatics. A cube with each side ' a ' is kept in an electric field given by $E = C \hat{i}$, (as is shown in the figure) where C is a positive dimensional constant. Find out

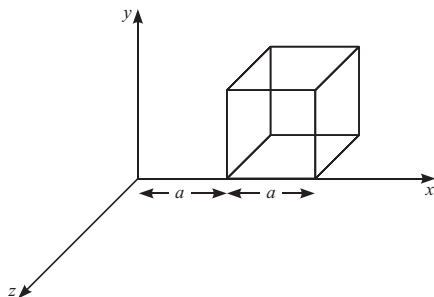

- (i) the electric flux through the cube, and
(ii) the net charge inside the cube
20. A capacitor of $200\mu\text{F}$ is charged by a 300V battery. The battery is then disconnected and the charged capacitor is connected to another uncharged capacitor of $100\mu\text{F}$. Calculate the difference between the final energy stored in the combined system and the initial energy stored in the single capacitor.
21. Draw a labelled diagram of a moving coil galvanometer and explain its working. What is the function of radial magnetic field inside the coil?
22. Define power of a lens. Write its units. Deduce the relation $\frac{1}{f} = \frac{1}{f_1} + \frac{1}{f_2}$ for two thin lenses kept in contact coaxially.

23. Write two characteristic features observed in photoelectric effect which support the photon picture of electromagnetic radiation.

Draw a graph between the frequency of incident radiation (ν) and the maximum kinetic energy of the electrons emitted from the surface of a photosensitive material. State clearly how this graph can be used to determine (i) Planck's constant and (ii) work function of the material.

24. Define modulation index. Give its physical significance. For an amplitude modulated wave, the maximum amplitude is found to be 10V while the minimum amplitude is 2V . Determine the modulation index.
25. Two cells of emfs \mathcal{E}_1 , \mathcal{E}_2 and internal resistance r_1 and r_2 respectively are connected in parallel as shown in the figure.

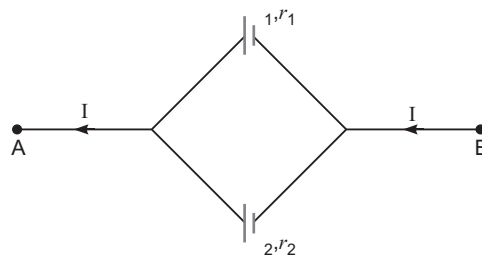

- Deduce the expressions for
- the equivalent e.m.f. of the combination,
 - the equivalent resistance of the combination, and
 - the potential difference between the points A and B.
26. Using Bohr's postulates for hydrogen atom, show that the total energy (E) of the electron in the stationary states can be expressed as the sum of kinetic energy (K) and potential energy (U), where $K = -2U$. Hence deduce the expression for the total energy in the n th energy level of hydrogen atom.
27. Define a wavelength. Use Huygens' geometrical construction to show the propagation of a plane wavefront from a rarer medium (i) to a denser medium (ii) undergoing refraction. Hence derive Snell's law of refraction.

OR

- (a) Use Huygens' geometrical construction to show the behaviour of a plane wavefront.
 (i) passing through a biconvex lens;
 (ii) reflecting by a concave mirror.
- (b) When monochromatic light is incident on a surface separating two media, why does the refracted light have the same frequency as that of the incident light?
- 28.** (a) What is the effect on the interference fringes in a Young's double slit experiment when
 (i) the separation between the two slits is decreased?
 (ii) the width of the source slit is increased?
 (iii) the monochromatic source is replaced by a source of white light?
 Justify your answer in each case.
- (b) The intensity at the central maxima in Young's double slit experimental set-up is I_0 . Show that the intensity at a point where the path difference is $\lambda/3$ is $I_0/4$.

OR

- (a) Obtain the conditions for the bright and dark fringes in diffraction pattern due to a single narrow slit illuminated by a monochromatic source.
 Explain clearly why the secondary maxima go on becoming weaker with increasing n .
- (b) When the width of the slit is made double, how would this affect the size and intensity of the central diffraction band? Justify.
- 29.** (a) State the principle on which AC generator works. Draw a labelled diagram and explain its working.
- (b) A conducting rod held horizontally along East-West direction is dropped from rest from a certain height near the Earth's surface. Why should there be an induced emf across the ends of the rod?
 Draw a plot showing the instantaneous variation of emf as a function of time from the instant it begins to fall.

OR

- (a) State the principle of a step-up transformer. Explain, with the help of a labelled diagram, its working.
- (b) Describe briefly any two energy losses, giving the reasons for their occurrence in actual transformers.
- 30.** (a) Draw the circuit for studying the input and output characteristics of an $n-p-n$ transistor in CE configuration. Show, how from the output characteristics, the information about the current amplification factor (β_{ac}) can be obtained.
- (b) Draw a plot of the transfer characteristic (V_0 versus V_i) for a base-biased transistor in CE configuration. Show for which regions in the plot, the transistor can operate as a switch.

OR

Why is a zener diode considered as a special purpose semiconductor diode?

Draw the I-V characteristic of a zener diode and explain briefly how reverse current suddenly increases at the breakdown voltage.

Describe briefly with the help of a circuit diagram how a zener diode works to obtain a constant dc voltage from the unregulated dc output of a rectifier.

CBSE (Foreign) Set-II

Questions uncommon to Set-I

1. What is the angle of dip at a place where the horizontal and vertical components of the Earth's magnetic field are equal?
2. Show on a graph variation of the de-Broglie wavelength (λ) associated with the electron versus $1/\sqrt{V}$, where V is the accelerating potential for the electron.
7. The closed loop (PQRS) of wire is moved out of a uniform magnetic field at right angles to the plane of the paper as shown in the figure. Predict the direction of the induced current in the loop.

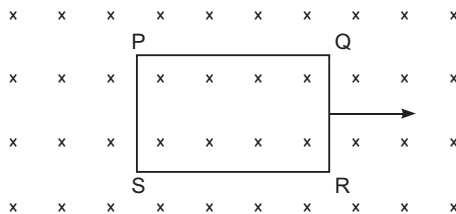

8. Why is there no work done in moving a charge from one point to another on an equipotential surface?
10. A magnetised needle of magnetic moment $4.8 \times 10^{-2} \text{ J T}^{-1}$ is placed at 30° with the direction of uniform magnetic field of magnitude $3 \times 10^{-2} \text{ T}$. Calculate the torque acting on the needle.
12. Trace the path of ray (P) of light passing through the glass prism as shown in the figure. The prism is made of glass with critical angle $i_c = 40^\circ$.

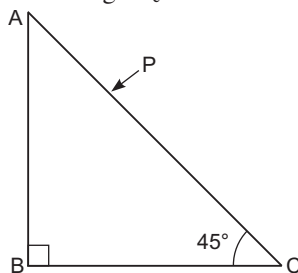

13. In a given sample, two radioactive nuclei, A and B , are initially present in the ratio of 4:1. The half lives of A and B are respectively 25 years. Find the time after which the amounts of A and B become equal.
14. Calculate the quality factor of a series LCR circuit with $L = 4.0 \text{ H}$, $C = 1 \text{ F}$ and $R = 20 \text{ } \Omega$. Mention the significance of quality factor in LCR circuit.
15. Figure shows a block diagram of a detector for amplitude modulated signal. Identify the boxes 'X' and 'Y' and write their functions.
26. A capacitor of 150 pF is charged by a 220 V battery. The battery is then disconnected and the charged capacitor is connected to another uncharged capacitor of 50 pF . Calculate the difference between the final energy stored in the combined system and the initial energy stored in the single capacitor.

CBSE (Foreign) Set-III**Questions uncommon to Set – I & II**

1. Write the relation between de-Broglie wavelength (λ) associated with the electron and its kinetic energy E .
2. What are isotopes? Give one example.
5. A small magnet is pivoted to move freely in the magnetic meridian. At what place on the surface of the Earth will the magnet be vertical?
7. Why do the equipotential due to a uniform electric field not intersect each other?
9. A right angle prism is placed as shown in the figure. Given that the prism is made of glass with critical angle 40° , trace the path of the ray P incident normal to the face AC .

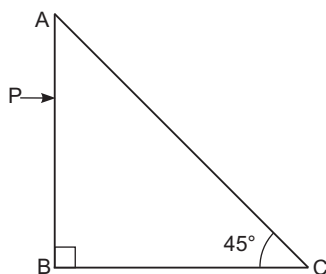

11. A short bar magnet of magnetic moment 0.5 J/T is placed with its axis is 30° to a uniform magnetic of 0.1 T . Calculate (i) the magnitude of the torque experienced and (ii) the direction on which it acts.
14. A conductor of length ' l ' is connected to a dc source of potential ' V '. If the length of the conductor is doubled by gradually stretching it, keeping ' V ' constant, how will (i) drift speed of electrons and (ii) resistance of the conductor be affected? Justify your answer.
15. Calculate the quality factor of a series LCR circuit with $L = 4.0 \text{ H}$, $C = 4 \text{ F}$ and $R = 20 \text{ } \Omega$. Mention the significance of quality factor in LCR circuit.
21. Define modulation index. Give its physical significance.
For an amplitude modulated wave, the maximum amplitude is $4V$. Determine the modulation index .
27. A capacitor of 400pF is charged by a $100V$ battery. The battery is then disconnected and the charged capacitor is connected to another uncharged capacitor of 100 pF . Calculate the difference between the final energy stored in the combined system and the initial energy stored in the single capacitor.

Solutions

CBSE (Foreign) Set-I

- Electric field intensity is zero inside the hollow spherical charged conductor. So, no work is done in moving a test charge inside the conductor and on its surface. Therefore, there is no potential difference between any two points inside or on the surface of the conductor.
- (a) 0° (b) 90°
- By Lenz's law, the direction of induced current is such that it opposes its own cause of production. The induced current opposes the increase in magnetic flux. Hence the direction of induced current is *PSRQP* (anticlockwise).
- (i) Infrared rays
(ii) Microwaves.
- We know $\frac{1}{f} = \frac{1}{R_1} + \frac{1}{R_2}$
 $f = \frac{1}{\left(\frac{1}{R_1} + \frac{1}{R_2}\right)}$ and $v = \frac{c}{\mu}$

The increase in refractive index would result in decrease of focal length of lens. Hence, we can say by replacing red light with violet light, decreases the focal length of the lens used.

- The relationship is

$$R = R_0 A^{1/3}$$

where R = Radius of nucleus

A = Mass number

- We know $\frac{1.22}{\sqrt{V}} \text{ \AA}$

$$\sqrt{V} = \text{constant}$$

The nature of the graph between λ and \sqrt{V} is hyperbola.

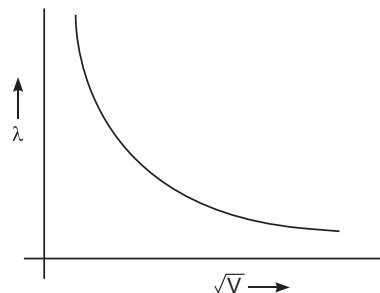

- Dipole moment of an electric dipole is the product of either of charge and the length of dipole. It is a vector quantity.

$$P = q(2a)$$

- (i) We know that $v_d = \frac{eV}{ml} = \frac{1}{l}$

When length is tripled, the drift velocity becomes one-third.

$$(ii) R = \frac{l}{A}, \quad l = 3l$$

New resistance

$$R \frac{l}{A} = \frac{3l}{A/3} = 9R$$

$$R' = 9R$$

Hence, the new resistance will be 9 times the original.

10. (i) By increasing resistance R the current through AB decreases, so potential gradient decreases. Hence a greater length of wire would be needed for balancing the same potential difference. So the null point would shift towards B .
- (ii) By decreasing resistance S , the current through AB remains the same, potential gradient does not change. As K_2 is open so there is no effect of S on null point.
11. When a particle of charge ' q ' of mass ' m ' is directed to move perpendicular to the uniform magnetic field ' B ' with velocity ' v '

The force on the charge

$$F = q(v \times B)$$

This magnetic force acts always perpendicular to the velocity of charged particle. Hence magnitude of velocity remains constant but direction changes continuously. Consequently the path of the charged particle in a perpendicular magnetic field becomes circular. The magnetic force (qvB) provides the necessary centripetal force to move along a circular path.

Then,
$$qvB = \frac{mv^2}{r} \quad r = \frac{mv}{qB}$$

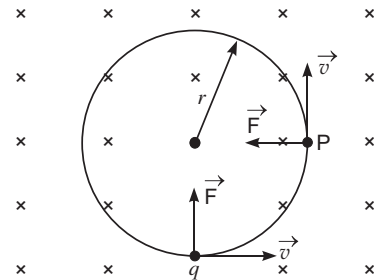

Here r = radius of the circular path followed by the charge.

12. We have,
$$Q = \frac{1}{R} \sqrt{\frac{L}{C}}$$

$$= \frac{1}{10} \sqrt{\frac{2}{2 \cdot 10^{-6}}} = 100$$

It signifies the sharpness of resonance.

13. An oscillating or accelerated is supposed to be source of an electromagnetic wave. An oscillating change produces an oscillating electric field in space which further produces an oscillating magnetic field which in turn is a source of electric field. These oscillating electric and magnetic field, hence, keep on regenerating each other and an electromagnetic wave is produced
- The frequency of em wave = Frequency of oscillating charge

14. We have
$$N = N_0 e^{-\lambda t}$$

For radio isotopes A and B, we can write

$$N_A = N_0 e^{-\lambda_A t} \quad \dots(i)$$

$$N_B = 4N_0 e^{-\lambda_B t} \quad \dots(ii)$$

Let t be the time after which $N_A = N_B$

$$t_A = t_B \quad t(\text{say})$$

$$N_0 e^{-\lambda t} = 4N_0 e^{-\lambda' t} \quad \therefore e^{-\lambda t} = 4 e^{-\lambda' t}$$

$$\log_e 4 = \lambda' t - \lambda t \log_e e$$

$$2 \log_e 2 = \frac{\log_e 2}{T_{B_{1/2}}} t - \frac{\log_e 2}{T_{A_{1/2}}} t \quad \therefore \frac{\log_e 2}{T} = 2 \left(\frac{1}{50} - \frac{1}{100} \right) t$$

$$t = 200 \text{ years}$$

15. X Amplitude Modulator
Y Power Amplifier

Function of X: The original message signal has very small energy and dies out very soon if transmitted directly as such. Hence, these signals are modulated by mixing with very high frequency waves (carrier wave) by modulator power.

Function of Y: The signal cannot be transmitted as such because they get weakened after travelling long distance. Hence, use of power amplifier provides them necessary power before feeding the signal to the transmitting antenna.

16. Given $n_g = \sqrt{3}$
 $i = 0^\circ$

At the interface AC,

By Snell's Law

$$\frac{\sin i}{\sin r} = \frac{n_g}{n_a}$$

But $\sin i = \sin 0^\circ = 0$, hence $r = 0^\circ$

At the interface AB, $i = 30^\circ$

Applying Snell's Law

$$\frac{\sin 30^\circ}{\sin e} = \frac{n_a}{n_g} = \frac{1}{\sqrt{3}} \quad \sin e = \sqrt{3} \sin 30^\circ \quad e = 60^\circ$$

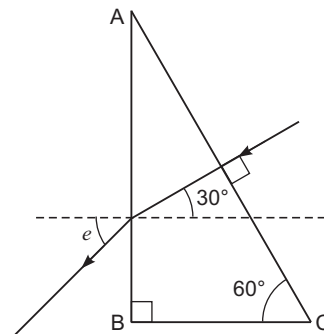

- 17.

n-type Semiconductor	p-type Semiconductor
(i) It is formed by doping pentavalent impurities.	(i) It is doped with trivalent impurities.
(iii) The electrons are majority carriers and holes are minority carriers ($n_e = n_h$).	(ii) The holes are majority carriers and electrons are minority carriers ($n_h = n_e$).

OR

A light emitting diode is simply a forward biased *p-n* junction which emits spontaneous light radiation. At the junction, energy is released in the form of photons due to the recombination of the excess minority charge carrier with the majority charge carrier.

Advantages

- (i) Low operational voltage and less power.
- (ii) Fast action and no warm up time required.

18. (i) We know $M = B \cos \theta$

$$\text{or } M = B \cos \theta$$

$$0.063 = 0.9 \times B \times \sin 30$$

$$\text{or } B = 0.14 \text{ T}$$

(ii) The position of minimum energy corresponds to position of stable equilibrium.

$$\text{The energy (U)} = -MB \cos \theta$$

$$\text{When } \theta = 0 \quad U = -MB = \text{Minimum energy}$$

Hence, when the bar magnet is placed parallel to the magnetic field, it is the state of stable equilibrium.

19. (i) Gauss's Law in electrostatics states that the total electric flux through a closed surface enclosing a charge is equal to $\frac{1}{\epsilon_0}$ times the magnitude of that charge.

$$\oint_s E \cdot dS = \frac{q}{\epsilon_0}$$

(ii) Net flux $\phi = \oint_s E \cdot dS$

$$\text{where } \phi = \int_1 E \cdot dS$$

$$= 2aC \int_1 dS \cos 0 = 2aC \int_1 dS = 2a^3 C$$

$$\phi_2 = aC \int_2 dS \cos 180 = -a^3 C$$

$$= 2a^3 C - (-a^3 C) = 3a^3 C \text{ Nm}^2 \text{ C}^{-1}$$

(iii) Net charge (q) enclosed = $3a^3 C$ coulomb

$$q = 3a^3 C \text{ coulomb.}$$

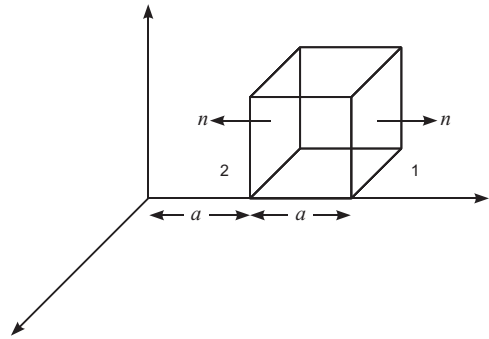

20. Initial energy of capacitor (U_i) = $\frac{1}{2} CV^2$

$$U_i = \frac{1}{2} \times 200 \times 10^{-12} \times (300)^2 = 9 \times 10^{-6} \text{ J}$$

$$\text{Charge on capacitor 'Q'} = CV = 200 \times 10^{-12} \times 300 = 6 \times 10^{-8} \text{ C}$$

When both capacitors are connected then let V be common potential difference across the two capacitors.

The charge would be shared between them.

$$\text{Hence, } Q = q_1 + q_2, \quad \frac{q_1}{C_1} = \frac{q_2}{C_2}$$

$$q_1 = \text{charge on capacitor (first)}$$

$$q_2 = \text{charge on capacitor (second)}$$

$$C_1 = 200 \text{ pF}, \quad C_2 = 100 \text{ pF}$$

$$\frac{q_1}{200 \times 10^{-12}} = \frac{q_2}{100 \times 10^{-12}} \quad q_1 = 2q_2$$

$$\text{Then } Q = q_1 + q_2 = 3q_2 \quad q_2 = \frac{Q}{3} = \frac{60 \text{ nC}}{3} = 20 \text{ nC}$$

and $q = 2q' = 40 \text{ nC}$

Hence, total final energy $U_f = \frac{q^2}{2C} = \frac{(40 \times 10^{-9})^2}{2 \times 200 \times 10^{-12}}$

$$U_f = \frac{1}{2} \frac{(40 \times 10^{-9})^2}{200 \times 10^{-12}} = \frac{1}{2} \frac{(20 \times 10^{-9})^2}{100 \times 10^{-12}}$$

$$U_f = 6 \times 10^{-6} \text{ J}$$

Energy difference $(U) = U_f - U_i = 6 \times 10^{-6} - 9 \times 10^{-6} = -3 \times 10^{-6} \text{ J}$

$U = 3 \times 10^{-6} \text{ J}$ (in magnitude)

21. Moving coil galvanometer: A galvanometer is used to detect current in a circuit.

Construction: It consists of a rectangular coil wound on a non-conducting metallic frame and is suspended by phosphor bronze strip between the pole-pieces (N and S) of a strong permanent magnet.

A soft iron core in cylindrical form is placed between the coil.

One end of coil is attached to suspension wire which also serves as one terminal (T_1) of galvanometer. The other end of coil is connected to a loosely coiled strip, which serves as the other terminal (T_2). The other end of the suspension is attached to a torsion head which can be rotated to set the coil in zero position. A mirror (M) is fixed on the phosphor bronze strip by means of which the deflection of the coil is measured by the lamp and scale arrangement. The levelling screws are also provided at the base of the instrument.

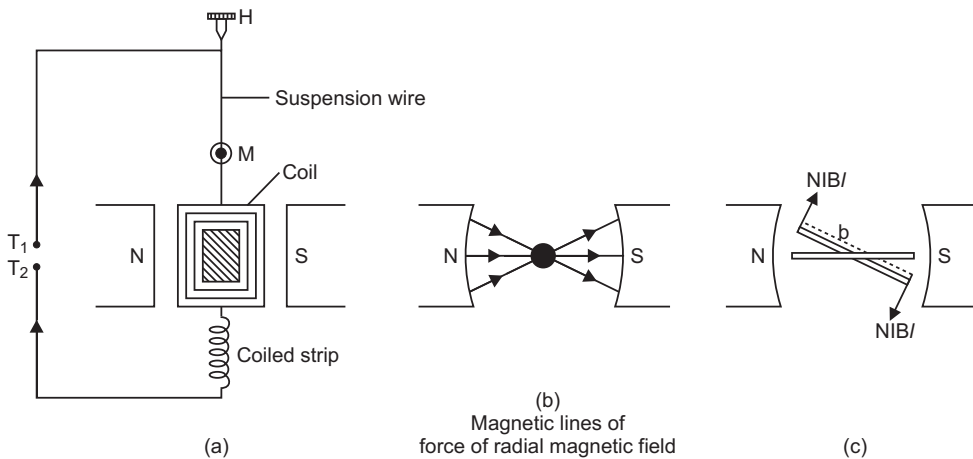

The pole pieces of the permanent magnet are cylindrical so that the magnetic field is radial at any position of the coil.

Principle and working: When current (I) is passed in the coil, torque acts on the coil, given by

$$NIAB \sin \theta$$

where θ is the angle between the normal to plane of coil and the magnetic field of strength B , N is the number of turns in a coil.

When the magnetic field is radial, as in the case of cylindrical pole pieces and soft iron core, then in every position of coil the plane of the coil, is parallel to the magnetic field lines, so that $\sin 90 = 1$

Deflecting torque, $NIAB$

If C is the torsional rigidity of the wire and θ is the twist of suspension strip, then restoring torque $C\theta$

For equilibrium, deflecting torque = restoring torque

i.e. $NIAB = C\theta$

$$\theta = \frac{NAB}{C} I \quad \dots(i)$$

i.e. $\theta \propto I$

deflection of coil is directly proportional to current flowing in the coil and hence we can construct a linear scale.

22. Power of lens: It is the reciprocal of focal length of a lens.

$$P = \frac{1}{f} \text{ (} f \text{ is in metre)}$$

Unit of power of lens: Diopter.

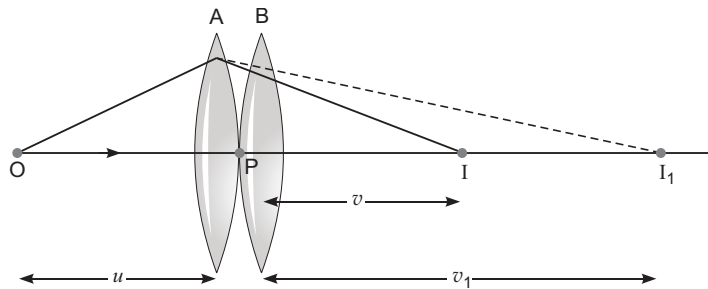

An object is placed at point O . The lens A produces an image at I_1 which serves as a virtual object for lens B which produces final image at I .

Given, the lenses are thin. The optical centres (P) of the lenses A and B is co-incident.

For lens A , we have

$$\frac{1}{v_1} - \frac{1}{u} = \frac{1}{f_1} \quad \dots(i)$$

For lens B , we have $\frac{1}{v} - \frac{1}{v_1} = \frac{1}{f_2} \quad \dots(ii)$

Adding equations (i) and (ii),

$$\frac{1}{v} - \frac{1}{u} = \frac{1}{f_1} + \frac{1}{f_2} \quad \dots(iii)$$

If two lenses are considered as equivalent to a single lens of focal length f , then

$$\frac{1}{v} - \frac{1}{u} = \frac{1}{f} \quad \dots(iv)$$

From equation (iii) and equation (iv), we can write

$$\frac{1}{f} = \frac{1}{f_1} = \frac{1}{f_2}$$

23. (a) All photons of light of a particular frequency ‘ ν ’ have same energy and momentum whatever the intensity of radiation may be.

(b) Photons are electrically neutral and are not affected by presence of electric and magnetic fields,

(i) From this graph, the Planck constant can be calculated by the slope of the current

$$h = \frac{(KE)}{\nu}$$

(ii) Work function is the minimum energy required to eject the photo-electron from the metal surface.

$h\nu_0$, where ν_0 = Threshold frequency

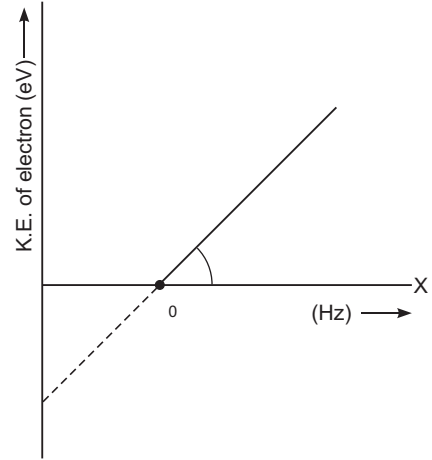

24. **Modulation index:** It is the ratio of peak value of modulating signal to the peak value of carrier wave.

$$\frac{A_m}{A_c}$$

Physical significance: It signifies the level of distortion or noise. A lower value of modulation index indicates a lower distortion in the transmitted signal.

Maximum amplitude, $A_{max} = A_c + A_m = 10 \text{ V}$

Minimum aptitude, $A_{min} = A_c - A_m = 2 \text{ V}$

Modulation index = $\frac{A_{max} - A_{min}}{A_{max} + A_{min}} = \frac{10 - 2}{10 + 2} = \frac{8}{12} = \frac{2}{3}$.

25. Here, $I = I_1 = I_2 \dots(i)$

Let V = Potential difference between A and B .

For cell 1

Then, $V = I_1 r_1 \implies I_1 = \frac{V}{r_1}$

Similarly, for cell $I_2 = \frac{2V}{r_2}$

Putting these values in equation (i)

$$I = \frac{1}{r_1} V = \frac{2}{r_2} V$$

or $I = \frac{1}{r_1} = \frac{2}{r_2} \implies V = \frac{1}{r_1} = \frac{1}{r_2}$

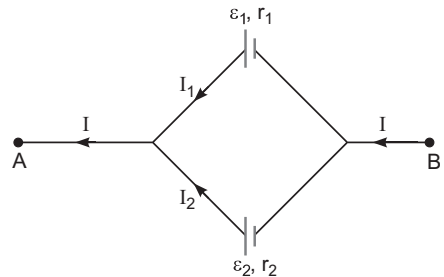

$$\text{or} \quad V = \frac{I r_1 r_2}{r_1 + r_2} \quad \dots(ii)$$

Comparing the above equation with the equivalent circuit of emf ' \mathcal{E} ' and internal resistance ' r_{eq} ' then,

$$\mathcal{E} = I r_{eq} \quad \dots(iii)$$

Then

$$(i) \quad r_{eq} = \frac{r_1 r_2}{r_1 + r_2} \quad (ii) \quad r_{eq} = \frac{r_1 r_2}{r_1 + r_2}$$

(iii) The potential difference between A and B

$$V = \mathcal{E} - I r_{eq}$$

- 26.** Energy of an electron in the stationary orbits of the hydrogen atom can be obtained by adding its kinetic and potential energies.

For electron revolving in an orbit of radius r hydrogen ($z = 1$) atom with speed v .

$$\frac{mv^2}{r} = \frac{1}{4} \frac{e^2}{r^2} \quad (\text{from first postulate of Bohr's atom model})$$

$$KE = \frac{1}{2} mv^2 = \frac{1}{2} \frac{e^2}{4r} \quad \dots(ii)$$

The potential energy is due to the presence of charge ($+e$) on the nucleus and is given by

$$\begin{aligned} PE &= \text{Potential} \times \text{charge} \\ &= \frac{1}{4} \frac{e^2}{r} \cdot (-e) = -\frac{1}{4} \frac{e^2}{r} \quad \dots(iii) \end{aligned}$$

Total energy = $KE + PE$

$$\begin{aligned} E_n &= \frac{1}{2} \frac{e^2}{4r} - \frac{1}{4} \frac{e^2}{r} \\ E_n &= -\frac{1}{4} \frac{e^2}{r} \quad \dots(iv) \end{aligned}$$

According to Bohr's second postulate

$$mvr = \frac{nh}{2\pi} \quad v = \frac{nh}{2\pi mr} \quad \dots(v)$$

From equation (i)

$$\begin{aligned} \frac{m}{r} \frac{n^2 h^2}{4\pi^2 m^2 r^2} &= \frac{1}{4} \frac{e^2}{r^2} \\ r &= \frac{n^2 h^2}{m e^2} \end{aligned}$$

Substituting the value of r in equation (iv), we have

$$E_n = -\frac{me^4}{8n^2 h^2}$$

27. Wavefront : A wavefront is a locus of all particles of medium vibrating in the same phase.

Huygen's Principle : There are some phenomena like interference, diffraction and polarisation which could not be explained by Newton's corpuscular theory. They were explained by wave theory first proposed by Huygen.

The assumptions of Huygen's theory are : (i) A source sends waves in all possible directions. **The locus of particles of a medium vibrating in the same phase is called a wavefront.** For a point source, the wavefront is spherical; while for a line source the wavefront is cylindrical. The distant wavefront is plane.

Each point of a wavefront acts as a source of secondary wavelets. The envelope of all wavelets at a given instant gives the position of a new wavefront.

Proof of Snell's law of Refraction using Huygen's wave theory : When a wave starting from one homogeneous medium enters the another homogeneous medium, it is deviated from its path. This phenomenon is called **refraction**. In transversing from first medium to another medium, the frequency of wave remains unchanged but its speed and the wavelength both are changed. Let XY be a surface separating the two media '1' and '2'. Let v_1 and v_2 be the speeds of waves in these media.

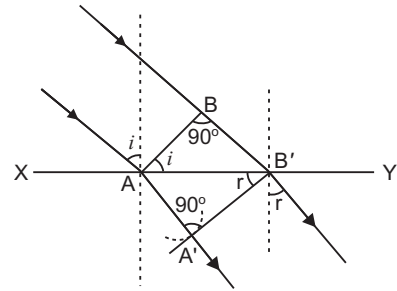

Suppose a plane wavefront AB in first medium is incident obliquely on the boundary surface XY and its end A touches the surface at A at time $t = 0$ while the other end B reaches the surface at point B after time-interval t . Clearly $BB = v_1 t$. As the wavefront AB advances, it strikes the points between A and B of boundary surface. According to Huygen's principle, secondary spherical wavelets originate from these points, which travel with speed v_1 in the first medium and speed v_2 in the second medium.

First of all secondary wavelet starts from A , which traverses a distance $AA' (= v_2 t)$ in second medium in time t . In the same time-interval t , the point of wavefront traverses a distance $BB (= v_1 t)$ in first medium and reaches B , from, where the secondary wavelet now starts. Clearly $BB = v_1 t$ and $AA = v_2 t$.

Assuming A as centre, we draw a spherical arc of radius $AA' (= v_2 t)$ and draw tangent $B'A$ on this arc from B' . As the incident wavefront AB advances, the secondary wavelets start from points between A and B , one after the other and will touch $A'B'$ simultaneously. According to Huygen's principle $A'B'$ is the new position of wavefront AB in the second medium. Hence **$A'B'$ will be the refracted wavefront.**

First law : As AB , $A'B'$ and surface XY are in the plane of paper, therefore the perpendicular drawn on them will be in the same plane. As the lines drawn normal to wavefront denote the rays, therefore we may say that the incident ray, refracted ray and the normal at the point of incidence all lie in the same plane.

This is the first law of refraction.

Second law : Let the incident wavefront AB and refracted wavefront $A'B'$ make angles i and r respectively with refracting surface XY .

In right-angled triangle ABB , $\angle ABB = 90^\circ$

$$\sin i = \frac{BB}{AB} = \frac{v_1 t}{AB} \quad \dots(i)$$

Similarly in right-angled triangle $AA'B$, $\angle AA'B = 90^\circ$

$$\sin r = \frac{AA'}{AB} = \frac{v_2 t}{AB} \quad \dots(ii)$$

Dividing equation (i) by (ii), we get

$$\frac{\sin i}{\sin r} = \frac{v_1}{v_2} = \text{constant} \quad \dots(iii)$$

As the rays are always normal to the wavefront, therefore the incident and refracted rays make angles i and r with the normal drawn on the surface XY i.e. i and r are the angle of incidence and angle of refraction respectively. According to equation (3) :

The ratio of sine of angle of incidence and the sine of angle of refraction is a constant and is equal to the ratio of velocities of waves in the two media. This is the second law of refraction, and is called the Snell's law.

When a light wave travels from rarer to denser medium, the speed decreases. It does not imply reduction its energy. This is because energy of wave depends on its frequency and not on its speed.

OR

(a) Wave Nature of Light : Huygen's Theory

There are some phenomena like interference, diffraction and polarisation which could not be explained by Newton's corpuscular theory. They were explained by wave theory first proposed by Huygen.

The assumptions of Huygen's theory are :

- (i) A source sends waves in all possible directions. **The locus of particles of a medium vibrating in the same phase is called a wavefront.** For a point source, the wavefront is spherical; while for a line source the wavefront is cylindrical. The distant wavefront is plane.
- (ii) Each point of a wavefront acts as a source of secondary wavelets. The envelope of all wavelets at a given instant gives the position of a new wavefront.

Rectilinear Propagation of Light : According to Newton's corpuscular theory, the path of light is a straight line, but according to wave theory the rectilinear propagation of light is only approximate.

- (i) **The action of a convex lens :** A plane wavefront becomes spherical convergent wavefront after refraction. Fig.

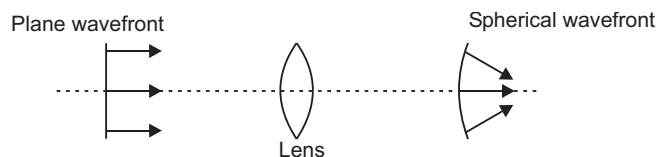

(ii) **Action of concave mirror :** A plane wavefront becomes spherical convergent after reflection. Fig.

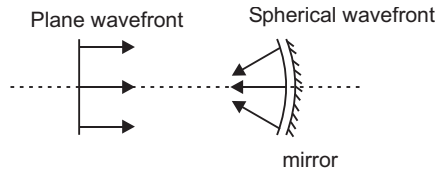

(b) As frequency of light is the characteristic of its source, light reflects and refracts due to the interaction of incident light with the atoms of the medium. These atoms always take up the frequency of the incident light which forces them to vibrate and emit light of same frequency. Hence, frequency remains same.

28. (a) (i) Fringe width $(\Delta x) = \frac{D}{d}$

If d decreases, Δx increases

(ii) For interference fringe, the condition is

$$\frac{s}{D} \ll \frac{\lambda}{d}$$

where s = size of source, D = distance of source from slits.

If the source slit width increases, fringe pattern gets less sharp or faint.

When the source slit is made wide which does not fulfil the above condition and interference pattern not visible.

(iii) The central fringes are white. On the either side of the central white fringe the coloured bands (few coloured maxima and minima) will appear. This is because fringes of different colours overlap.

(b) Intensity at a point is

$$I = I_0 \cos^2 \frac{\phi}{2}$$

At path difference $\frac{\lambda}{3}$, the phase difference, $\frac{2\pi}{\lambda} \cdot \frac{\lambda}{3} = \frac{2\pi}{3}$

$$I = I_0 \cos^2 \frac{1}{2} \cdot \frac{2\pi}{3} = I_0 \cos^2 \frac{\pi}{3} = \frac{I_0}{4}$$

OR

(a) **Diffraction of light at a single slit :** When monochromatic light is made incident on a single slit, we get diffraction pattern on a screen placed behind the slit. The diffraction pattern contains bright and dark bands, the intensity of central band is maximum and goes on decreasing on both sides.

Explanation : Let AB be a slit of width ' a ' and a parallel beam of monochromatic light is incident on it. According to Fresnel the diffraction pattern is the result of superposition of a large number of waves, starting from different points of illuminated slit.

Let θ be the angle of diffraction for waves reaching at point P of screen and AN the perpendicular dropped from A on wave diffracted from B .

The path difference between rays diffracted at points A and B ,

$$BP - AP = BN$$

In $\triangle ANB$, $\angle ANB = 90^\circ$ and $\angle BAN = \theta$

$$\sin \theta = \frac{BN}{AB} \text{ or } BN = AB \sin \theta$$

As $AB = a$ width of slit

Path difference,

$$a \sin \theta \quad \dots(i)$$

To find the effect of all coherent waves at P , we have to sum up their contribution, each with a different phase. This was done by Fresnel by rigorous calculations, but the main features may be explained by simple arguments given below :

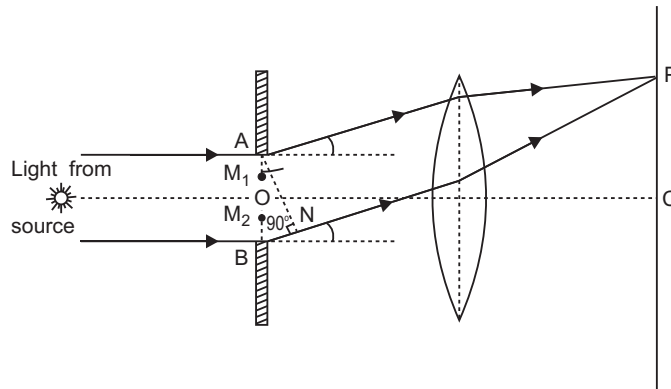

At the central point C of the screen, the angle θ is zero. Hence the waves starting from all points of slit arrive in the same phase. This gives maximum intensity at the central point C .

If point P on screen is such that the path difference between rays starting from edges A and B is $a \sin \theta$, then path difference

$$a \sin \theta = \frac{a}{2} \sin \theta - \frac{a}{2} \sin \theta$$

If angle θ is small, $\sin \theta \approx \theta$ $\dots(ii)$

Minima : Now we divide the slit into two equal halves AO and OB , each of width $\frac{a}{2}$. Now for

every point, M_1 in AO , there is a corresponding point M_2 in OB , such that $M_1M_2 = \frac{a}{2}$; Then

path difference between waves arriving at P and starting from M_1 and M_2 will be $\frac{a}{2} \sin \theta - \frac{a}{2} \sin \theta$. This means that the contributions from the two halves of slit AO and OB are

opposite in phase and so cancel each other. Thus equation (2) gives the angle of diffraction at which intensity falls to zero. Similarly it may be shown that the intensity is zero for

$\sin \theta = \frac{n\lambda}{a}$, with n as integer. Thus the general condition of **minima** is

$$a \sin \theta = n\lambda \quad \dots(iii)$$

Secondary Maxima : Let us now consider angle θ such that

$$\sin^{-1} \frac{3}{2a}$$

which is midway between two dark bands given by

$$\sin^{-1} \frac{1}{a} \text{ and } \sin^{-1} \frac{2}{a}$$

Let us now divide the slit into three parts. If we take the first two of parts of slit, the path difference between rays diffracted from the extreme ends of the first two parts

$$\frac{2}{3} a \sin \theta \quad \frac{2}{3} a \quad \frac{3}{2a}$$

Then the first two parts will have a path difference of $\frac{a}{2}$ and cancel the effect of each other.

The remaining third part will contribute to the intensity at a point between two minima. Clearly there will be a maxima between first two minima, but this maxima will be of much weaker intensity than central maximum. This is called *first secondary maxima*. In a similar manner we can show that there are secondary maxima between any two consecutive minima; and the intensity of maxima will go on decreasing with increase of order of maxima. In general the position of n th maxima will be given by

$$a \sin \theta = n \frac{\lambda}{2}, \quad [n = 1, 2, 3, 4, \dots] \quad \dots(iv)$$

The intensity of secondary maxima decrease with increase of order n because with increasing n , the contribution of slit decreases.

For $n = 2$, it is one-fifth, for $n = 3$, it is one-seventh and so on.

(b) Width of central Maxima ' $\Delta \theta = \frac{2D}{a}$

a size of slit

If size of slit is doubled, width of central maxima becomes half. Intensity varies as square of slit width. If width of slit is doubled, intensity gets four times.

29. (a) **AC generator:** A dynamo or generator is a device which converts mechanical energy into electrical energy. It is based on the principle of electromagnetic induction.

Construction: It consists of the four main parts:

- (i) **Field Magnet:** It produces the magnetic field. In the case of a low power dynamo, the magnetic field is generated by a permanent magnet, while in the case of large power dynamo, the magnetic field is produced by an electromagnet.
- (ii) **Armature:** It consists of a large number of turns of insulated wire in the soft iron drum or ring. It can revolve round an axle between the two poles of the field magnet. The drum or ring serves the two purposes: (i) It serves as a support to coils and (ii) It increases the magnetic field due to air core being replaced by an iron core.
- (iii) **Slip Rings:** The slip rings R_1 and R_2 are the two metal rings to which the ends of armature coil are connected. These rings are fixed to the shaft which rotates the armature coil so that the rings also rotate along with the armature.
- (iv) **Brushes:** These are two flexible metal plates or carbon rods (B_1 and B_2) which are fixed and constantly touch the revolving rings. The output current in external load R_L is taken through these brushes.

Working: When the armature coil is rotated in the strong magnetic field, the magnetic flux linked with the coil changes and the current is induced in the coil, its direction being given by Fleming's right hand rule. Considering the armature to be in vertical position and as it rotates in anticlockwise direction, the wire ab moves upward and cd downward, so that the direction of induced current is shown in fig. In the external circuit, the current flows along $B_1 R_L B_2$. The direction of current remains unchanged during the first half turn of armature. During the second half revolution, the wire ab moves downward and cd upward, so the direction of current is reversed and in external circuit it flows along $B_2 R_L B_1$. Thus the direction of induced emf and current changes in the external circuit after each half revolution.

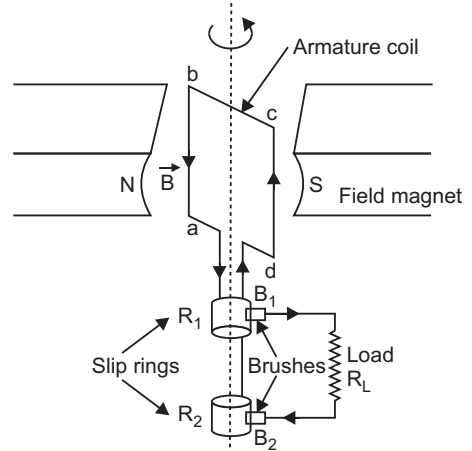

Expression for Induced emf: If N is the number of turns in coil, f the frequency of rotation, A area of coil and B the magnetic induction, then induced emf

$$e = \frac{d}{dt} \left\{ NBA (\cos 2\pi f t) \right\}$$

$$= 2\pi NBA f \sin 2\pi f t$$

Obviously, the emf produced is alternating and hence the current is also alternating.

Current produced by an ac generator cannot be measured by moving coil ammeter; because the average value of ac over full cycle is zero.

The source of energy generation is the mechanical energy of rotation of armature coil.

- (b) As the earth's magnetic field lines are cut by the falling rod, the change in magnetic flux takes place. This change in flux induces an emf across the ends of the rod.

Since the rod is falling under gravity,

$$v = gt \quad (\because u = 0)$$

$$\text{Induced emf, } \mathcal{E} = Blv$$

$$= \frac{Blgt}{t}$$

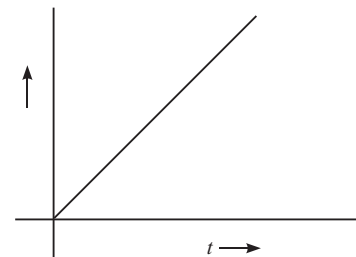

OR

- (a) **Transformer:** Transformer is a device by which an alternating voltage may be decreased or increased. This is based on the principle of mutual-induction.

Construction: It consists of laminated core of soft iron, on which two coils of insulated copper wire are separately wound. These coils are kept insulated from each other and from the iron-core, but are coupled through mutual induction. The number of turns in these coils are different. Out of these coils one coil is called *primary coil* and other is called the *secondary coil*. The terminals of primary coils are connected to AC mains and the terminals of the secondary coil are connected to external circuit in which alternating current of desired voltage is required. Transformers are of two types:

1. **Step up Transformer:** It transforms the alternating low voltage to alternating high voltage and in this the number of turns in secondary coil is more than that in primary coil. (i.e., $N_S > N_P$).
2. **Step down Transformer:** It transforms the alternating high voltage to alternating low voltage and in this the number of turns in secondary coil is less than that in primary coil (i.e., $N_S < N_P$).

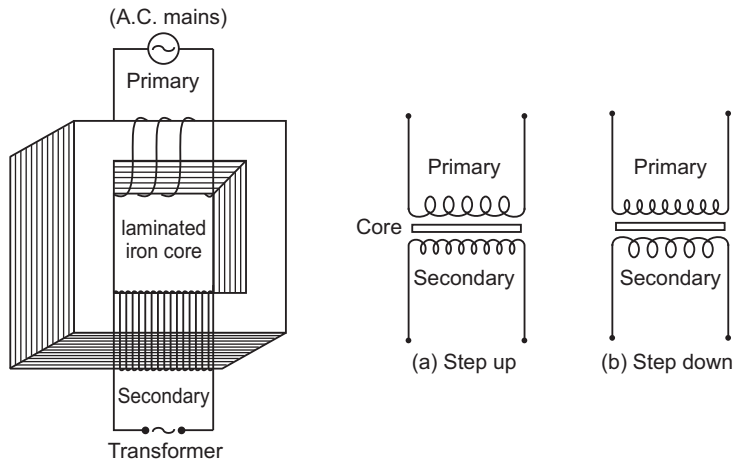

Working: When alternating current source is connected to the ends of primary coil, the current changes continuously in the primary coil; due to which the magnetic flux linked with the secondary coil changes continuously, therefore the alternating emf of same frequency is developed across the secondary.

Let N_p be the number of turns in primary coil, N_S the number of turns in secondary coil and the magnetic flux linked with each turn. **We assume that there is no leakage of flux so that the flux linked with each turn of primary coil and secondary coil is the same.** According to Faraday's laws the emf induced in the primary coil

$$e_p = -N_p \frac{d\phi}{dt} \quad \dots(i)$$

and emf induced in the secondary coil

$$e_s = -N_S \frac{d\phi}{dt} \quad \dots(ii)$$

From (i) and (ii)

$$\frac{e_s}{e_p} = \frac{N_S}{N_P} \quad \dots(iii)$$

If the resistance of primary coil is negligible, the emf (e_p) induced in the primary coil, will be equal to the applied potential difference (V_p) across its ends. Similarly if the secondary circuit is open, then the potential difference V_S across its ends will be equal to the emf (e_s) induced in it; therefore

$$\frac{V_S}{V_P} = \frac{e_s}{e_p} = \frac{N_S}{N_P} \quad r \text{ (say)} \quad \dots(iv)$$

where $r = \frac{N_S}{N_P}$ is called the *transformation ratio*. If i_p and i_s are the instantaneous currents in primary and secondary coils and there is no loss of energy; then

For about 100% efficiency, Power in primary = Power in secondary

$$\frac{V_p i_p}{i_p} = \frac{V_s i_s}{i_s} \quad \dots(v)$$

In step up transformer, $N_s > N_p$ $r > 1$;

So $V_s > V_p$ and $i_s < i_p$

i.e. step up transformer increases the voltage.

(b) (i) **Flux leakage:** There is always some flux leakage, that is, not all of the flux due to primary passes through the secondary due to poor design of the core or the air gaps in the core.

(ii) **Eddy currents:** The alternating magnetic flux induces eddy currents in the iron core and causes heating.

30. (a) **Characteristic Curves:** The circuit diagram for determining the static characteristic curves of an *n-p-n* transistor in common-emitter configuration is shown in figure.

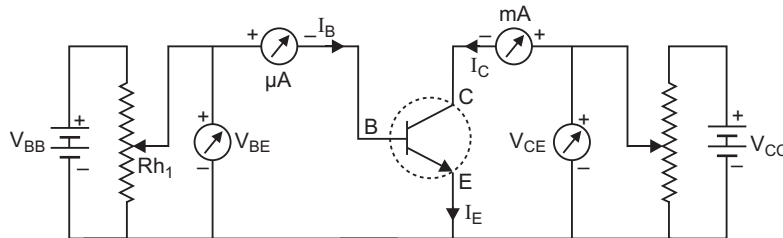

Output characteristics: These characteristics are obtained by plotting collector current I_C versus collector-emitter voltage V_{CE} at a fixed value of base current I_B . The base current is changed to some other fixed value and the observations of I_C versus V_{CE} are repeated. Fig. represents the output characteristics of a common-emitter circuit.

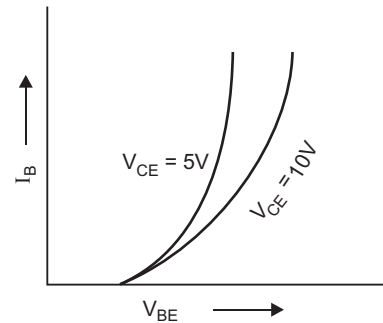

The characteristic curves show:

(i) **When collector-emitter voltage V_{CE} is increased from zero, the collector current I_C increases as V_{CE} increases from 0 to 1 V only and then the collector current becomes almost constant and independent of V_{CE} . The value of V_{CE} upto which collector current I_C changes is called the *knee voltage* V_{knee} .**

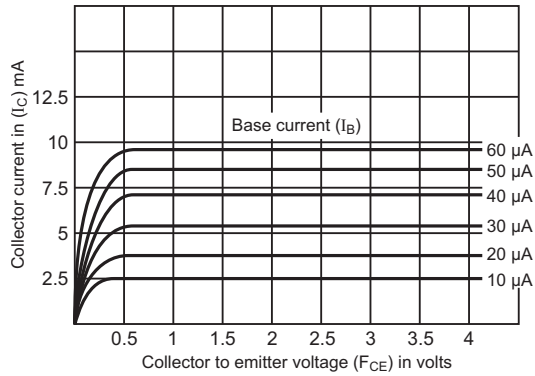

Determination of Current Gain

Current gain $\frac{I_C}{I_B}$ V_{CE}

We take the active region of output characteristics *i*, the region where collector current (I_C) is almost independent of V_{CE} .

Now we choose any two characteristic curves for given values of I_B and find the two corresponding values of I_C .

Then $\frac{I_C}{I_B} = \frac{(I_C)_2}{(I_B)_2} = \frac{(I_C)_1}{(I_B)_1}$

From graph $(I_C)_1 = 5.2 \text{ mA}$, $(I_C)_2 = 7.3 \text{ mA}$

$(I_B)_1 = 30 \text{ A}$, $(I_B)_2 = 40 \text{ A}$

$$\frac{(7.3 - 5.2) \text{ mA}}{(40 - 30) \text{ A}} = \frac{2.1 \times 10^{-3}}{10 \times 10^{-6}} \quad \mathbf{210}$$

Using any two curves from output characteristics current amplification factor $a_c = \frac{I_C}{I_B}$.

- (b) A switch is a device which can turn ON and OFF current in an electrical circuit. A transistor can be used to turn current ON or OFF rapidly in electrical circuits.

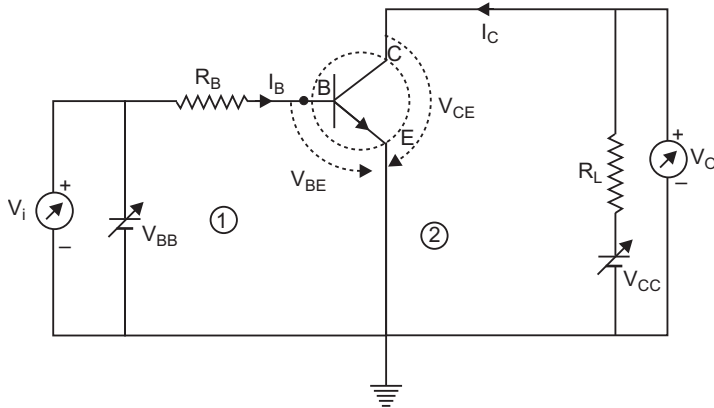

Operation: The circuit diagram of $n-p-n$ transistor in CE configuration working as a switch is shown in fig. V_{BB} and V_{CC} are two dc supplies which bias base-emitter and emitter collector junctions respectively.

Let V_{BB} be the input supply voltage. This is also input dc voltage (V_i). The dc output voltage is taken across collector-emitter terminals, R_L is the load resistance in output circuit.

Applying Kirchoff's second law to input and output meshes (1) and (2), we get

$$V_{BB} - I_B R_B - V_{BE} = 0 \quad \dots(i)$$

$$\text{and } V_{CC} - I_C R_L - V_{CE} = 0 \quad \dots(ii)$$

We have $V_{BB} = V_i$ and $V_{CE} = V_0$, so above equations take the form

$$V_i - V_{BE} - I_B R_B = 0 \quad \dots(iii)$$

$$\text{and } V_0 - V_{CE} - I_C R_L = 0 \quad \dots(iv)$$

Let us see the change in V_0 due to a change in V_i . In case of Si transistor; the barrier voltage across base-emitter junction is 0.6 V. Therefore, when V_i is less than 0.6 V, there is no collector current ($I_C = 0$), so transistor will be in cut off state. Hence, from (iv) with $I_C = 0$; $V_0 = V_{CC}$.

When V_i becomes greater than 0.6 V, I_C begins to flow and increase with increase of V_i . Thus, from (iv), V_0 decreases upto $V_i = 1$ V; the increase in I_C is linear and so decrease in output voltage V_0 is **linear**.

Beyond $V_i = 1$ V, the change in collector current and hence in output voltage V_0 is non-linear and the transistor goes into saturation. With further increase in V_i , the output voltage further decrease towards zero (though it never becomes zero).

If we plot V_0 versus V_i , we get the graph as shown in fig. [This characteristics curve is also called transfer characteristic curve of base biased transistor.]

The curve shows that there are non-linear regions.

(i) between cut off state and active state and (ii) between active state and saturation state; thus showing that the transitions (i) from cut off to active state and from active to saturation state are not sharply defined.

Now we are in the position to explain the action of **transistor as a switch**. When transistor is non-conducting ($I_C = 0$), it is said to be '**switched off**' but when it is conducting (I_C is not zero); it is said to be '**switched ON**'.

As long as input voltage V_i is low and unable to overcome the barrier voltage of the emitter base junction, V_0 is high ($I_C = 0$ and $V_0 = V_{CC}$), so the transistor is 'switched OFF' and if it is high enough to derive the transistor into saturation (I_C is high and so $V_0 = V_{CC} - I_C R_L$) is low, very near to zero, so the transistor is 'switched ON'. Thus we can say low input switches the transistor is **OFF state** and high input switches it ON.

The switching circuits are designed in such a way that the transistor does not remain in active state.

The transistor can operate as a switch in cut off region and saturation region.

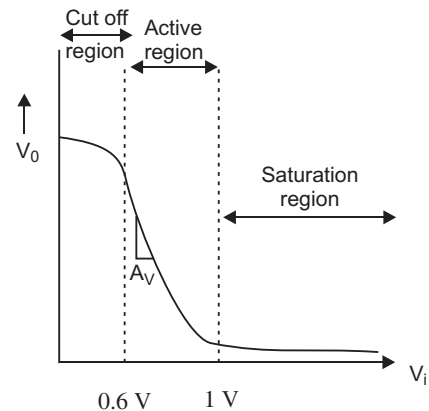

OR

A zener diode is considered as a special purpose semiconductor diode because it is designed to operate under reverse bias in the breakdown region.

We know that reverse current is due to the flow of electrons (minority carriers) from p n and holes from n p . As the reverse bias voltage is increased, the electric field at the junction becomes significant. When the reverse bias voltage $V = V_z$, then the electric field strength is high enough to pull valence electrons from the host atoms on the p -side which are accelerated to n -side. These electrons causes high current at breakdown.

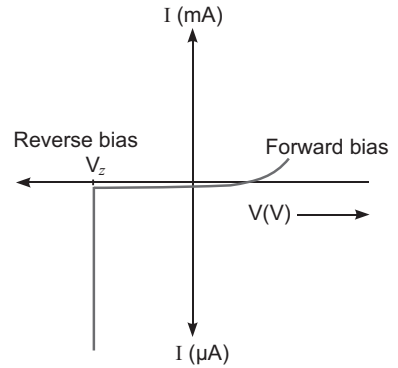

Working:

The unregulated dc voltage output of a rectifier is connected to the zener diode through a series resistance R_s such that the zener diode is reverse biased. Now, any increase/decrease in the input voltage results in increase/decrease of the voltage drop across R_s without any change in voltage across the zener diode. Thus, the zener diode acts as a voltage regulator.

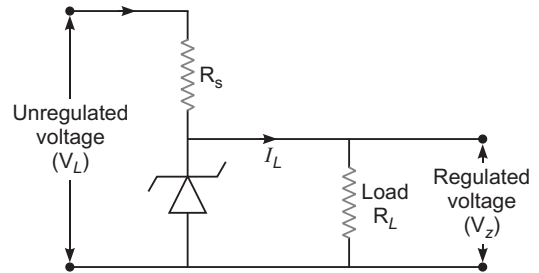

CBSE (Foreign) Set-II

1. We know $\frac{B_V}{B_H} \tan$
 Given $B_V = B_H$ then $\tan = 1$
 Angle of dip, 45°
2. $\frac{h}{\sqrt{2} \text{ meV}}$

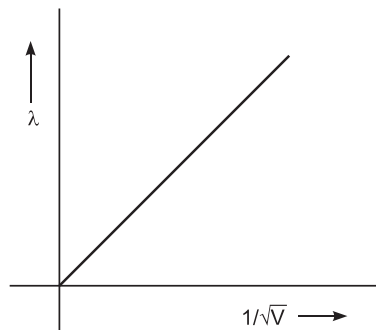

7. From the given figure, it is clear that the magnetic flux decreases. By Lenz's law, the induced current opposes the change in flux by producing the magnetic field in the same direction as the external magnetic field. By right hand thumb rule, the induced current will flow in a clockwise direction. *i.e.*, *PQRSP*.

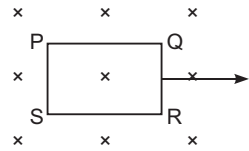

8. The potential difference between any two points of equipotential surface is zero. We have

$$\frac{W}{q} = dv \quad (\because dv = 0)$$

Thus $W = 0$, the work done in moving a charge on an equipotential is zero.

10. We have, $\tau = M B \sin \theta$

where τ = torque acting on magnetic needle

M = Magnetic moment

B = Magnetic field strength

$$\begin{aligned} \text{Then } \tau &= 4.8 \times 10^{-2} \times 3 \times 10^{-2} \sin 30^\circ \\ &= 4.8 \times 10^{-2} \times 3 \times 10^{-2} \times \frac{1}{2} \\ &= 7.2 \times 10^{-4} \text{ Nm} \end{aligned}$$

12. From the figure, the incident ray is normal to the surface of prism. So, incident angle = 0°

Then, angle of refraction will be zero. It means that the ray of light will pass through the prism undeviated, reaches the other end of prism.

The second angle of incident = 45° (greater than critical angle of prism). The ray of light undergoes the phenomenon of total internal reflection and continues in the same manner.

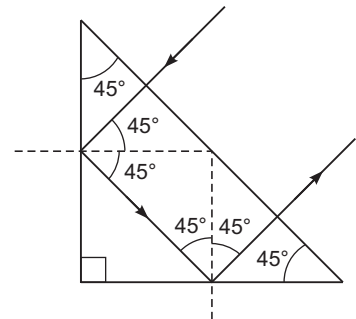

13. We have $N = N_0 e^{-\lambda t}$

For radio isotopes A and B, we can write

$$N_A = 4N_0 e^{-\lambda_A t}$$

$$N_B = N_0 e^{-\lambda_B t}$$

Let t be the time after which $N_A = N_B$

$$4N_0 e^{-\lambda_A t} = N_0 e^{-\lambda_B t}$$

$$4 e^{-\lambda_A t} = e^{-\lambda_B t}$$

$$\log_e 4 = (\lambda_B t - \lambda_A t) \log_e e$$

$$2 \log_e 2 = \frac{\log_e 2}{T_{A1/2}} - \frac{\log_e 2}{T_{B1/2}} t \qquad 2 = \frac{1}{25} - \frac{1}{50} t$$

$$2 = \frac{2}{50} t \qquad t = 100 \text{ years.}$$

14. We have, the quality factor ' Q ' of a series LCR

$$Q = \frac{1}{R} \sqrt{\frac{L}{C}} \quad \text{Here, } R = 20, L = 4H, C = 10^{-6}F$$

$$Q = \frac{1}{20} \sqrt{\frac{4}{10^{-6}}} = 100$$

The quality factor measures the sharpness of resonance of an LCR circuit.

15. Here X Rectifier
 Y Envelope detector

Rectifier: It allows only the positive half of the AM input wave to go onwards.
It separates the message signal from the carrier wave.

26. Given, $C_1 = 150 \text{ pF} = 150 \times 10^{-12}F$
 $V_1 = 200 \text{ V}$

Initial energy of the first capacitor

$$U_1 = \frac{1}{2} C_1 V_1^2 = \frac{1}{2} (150 \times 10^{-12}) (200)^2$$

$$= 3 \times 10^{-6} \text{ J}$$

When another uncharged capacitor of capacitance $C_2 = 50 \text{ pF} = 50 \times 10^{-12}F$ is connected across the first capacitor, common potential (V) =

$$= \frac{q_1}{C_1} = \frac{q_2}{C_2} = \frac{C_1 V_1}{C_1 + C_2}$$

$$= \frac{150 \times 10^{-12} \times 200}{(150 + 50) \times 10^{-12}} = 150 \text{ V}$$

Final energy, $U_2 = \frac{1}{2} (C_1 + C_2) V^2$

$$= \frac{1}{2} (150 + 50) \times 10^{-12} (150)^2 = 2.25 \times 10^{-6} \text{ J}$$

Change in energy, $U_2 - U_1 = 2.25 \times 10^{-6} - 3 \times 10^{-6} = -0.75 \times 10^{-6} \text{ J}$

CBSE (Foreign) Set-III

1. Relation between the de Broglie wavelength (λ) associated with the electron and its kinetic energy

$$\lambda = \frac{h}{\sqrt{2mE}} \quad \text{where } m = \text{Mass of electron}$$

$$E = KE \text{ of electron}$$

2. Isotopes are the two or more nuclides having the same atomic number (Z) but different mass number (A).

One example of isotope is 1_1H , 2_1H , 3_1H . (i.e., isotopes of hydrogen)

5. Poles of the earth.

7. This is because, at the point of intersection there will be two values of electric potential which is not possible.

9. From the given figure, incident angle = 0

Then angle of refraction will be zero. Thus the light ray will pass through the prism undeviated, and reaches to the other end of prism.

The second angle of incident = 45° which is greater than the critical angle of prism.

Hence the light ray undergoes the phenomenon of total internal reflection making angle 90° with the incident ray.

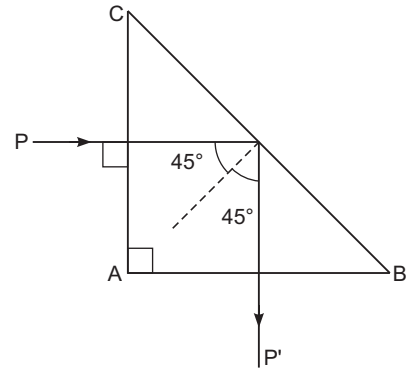

11. (i) We know $\tau = MB \sin \theta$

where τ = Torque acting on a short bar magnet

M = Magnetic moment

B = Magnetic field

$$= 0.5 \times 0.1 \times \sin 30^\circ$$

$$= 0.5 \times 0.1 \times \frac{1}{2} = 2.5 \times 10^{-2} \text{ Nm}$$

- (ii) The direction of torque is always perpendicular to the plane containing magnetic moment and magnetic field $M \times B$.

14. (i) We know that drift speed

$$v_d = \frac{eV}{ml} \cdot \frac{1}{l}$$

When length of the conductor is doubled, drift velocity gets halved.

- (ii) As $R = \frac{l}{A}$

Now, $l = 2l$ and $A = \frac{A}{2}$

$$\text{New resistance, } R = \frac{(2l)}{\frac{A}{2}} = 4 \frac{l}{A}$$

Thus, resistance becomes four times.

15. We have, the quality factor of a series LCR.

$$Q = \frac{1}{R} \sqrt{\frac{L}{C}} \quad \text{where } R = 20$$

$$C = 4 \text{ F}$$

$$L = 4 \text{ H}$$

$$Q = \frac{1}{20} \sqrt{\frac{4}{4 \cdot 10^{-6}}} = \frac{1}{20} \cdot 10^3$$

$$Q = 50$$

The quality factor measures the sharpness of resonance of an LCR circuit.

21. **Modulation index:** It is the ratio of peak value of modulating signal to the peak value of carrier wave.

$$\frac{A_m}{A_c}$$

It signifies the level of distortion.

Maximum amplitude, $A_{max} = A_c + A_m = 8V$

Minimum amplitude, $A_{min} = A_c - A_m = 4V$

$$\begin{aligned} &= \frac{A_{max}}{A_{min}} = \frac{8}{4} = 2 \\ &= \frac{A_{max}}{A_c} = \frac{8}{4} = 2 \end{aligned}$$

27. Given, $C_1 = 400 \text{ pF} = 400 \times 10^{-12} \text{ F}$

$$V_1 = 100 \text{ V}$$

$$\begin{aligned} \text{Initial energy, } U_1 &= \frac{1}{2} C_1 V_1^2 \\ &= \frac{1}{2} \times 400 \times 10^{-12} \times (100)^2 \\ &= 2 \times 10^{-6} \text{ J} \end{aligned}$$

When another uncharged capacitor of capacitance $C_2 = 100 \text{ pF}$ is connected across the first

$$\begin{aligned} \text{capacitor, common potential (V)} &= \frac{q_1}{C_1} = \frac{q_2}{C_2} = \frac{C_1 V_1}{C_1 + C_2} \\ &= \frac{400 \times 10^{-12} \times 100}{(400 + 100) \times 10^{-12}} = 80 \text{ V} \end{aligned}$$

$$\begin{aligned} \text{Final energy, } U_2 &= \frac{1}{2} (C_1 + C_2) V^2 \\ &= \frac{1}{2} (400 + 100) \times 10^{-12} \times (80)^2 = 1.6 \times 10^{-6} \text{ J} \end{aligned}$$

Difference in energy

$$\begin{aligned} U_2 - U_1 &= 1.6 \times 10^{-6} \text{ J} - 2 \times 10^{-6} \text{ J} \\ &= -0.4 \times 10^{-6} \text{ J} \end{aligned}$$

CBSE Examination Papers

Delhi–2013

SET-I

Time allowed : 3 hours

Maximum marks: 70

General Instructions:

- (i) All questions are compulsory.
- (ii) There are 29 questions in total. Questions 1 to 8 are very short answer questions and carry one mark each.
- (iii) Questions 9 to 16 carry two marks each, questions 17 to 25 carry three marks each, **question 26 is value-based question** carry four marks and questions 27 to 29 carry five marks each.
- (iv) There is no overall choice. However, an internal choice has been provided in one question of two marks, one question of three marks and all three questions of five marks each. You have to attempt only one of the given choices in such questions.
- (v) Use of calculators is not permitted. However, you may use log tables if necessary.
- (vi) You may use the following values of physical constants wherever necessary.

$$c \quad 3 \times 10^8 \text{ m/s}$$

$$h \quad 6.63 \times 10^{-34} \text{ Js}$$

$$e \quad 1.6 \times 10^{-19} \text{ C}$$

$$\mu_0 \quad 4 \times 10^{-7} \text{ TmA}^{-1}$$

$$\frac{1}{4\pi\epsilon_0} \quad 9 \times 10^9 \text{ Nm}^2 / \text{C}^2$$

$$m_e \quad 9.1 \times 10^{-31} \text{ kg}$$

1. What are permanent magnets? Give one example.
2. What is the geometrical shape of equipotential surfaces due to a single isolated charge?
3. Which of the following waves can be polarized (i) Heat waves (ii) Sound waves? Give reason to support your answer.
4. A capacitor has been charged by a dc source. What are the magnitudes of conduction and displacement currents, when it is fully charged?
5. Write the relationship between angle of incidence 'i', angle of prism 'A' and angle of minimum deviation for a triangular prism.

6. The given graph shows the variation of photo-electric current (I) versus applied voltage (V) for two different photosensitive materials and for two different intensities of the incident radiation. Identify the pairs of curves that correspond to different materials but same intensity radiation.

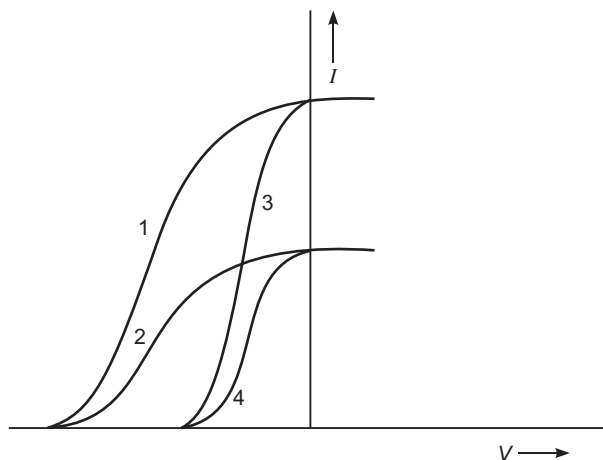

7. A 10 V battery of negligible internal resistance is connected across a 200 V battery and a resistance of 38Ω as shown in the figure. Find the value of the current in circuit.

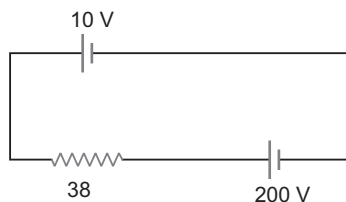

8. The emf of a cell always greater than its terminal voltage. Why? Give reason.
9. (a) Write the necessary conditions for the phenomenon of total internal reflection to occur.
 (b) Write the relation between the refractive index and critical angle for a given pair of optical media.
10. State Lenz's Law.
 A metallic rod held horizontally along east-west direction, is allowed to fall under gravity. Will there be an emf induced at its ends? Justify your answer.
11. A convex lens of focal length 25 cm is placed coaxially in contact with a concave lens of focal length 20 cm. Determine the power of the combination. Will the system be converging or diverging in nature?
12. An ammeter of resistance 0.80Ω can measure current upto 1.0 A.
 (i) What must be the value of shunt resistance to enable the ammeter to measure current upto 5.0 A?
 (ii) What is the combined resistance of the ammeter and the shunt?

13. In the given circuit diagram, a voltmeter 'V' is connected across a lamp 'L'. How would (i) the brightness of the lamp and (ii) voltmeter reading 'V' be affected, if the value of resistance 'R' is decreased? Justify your answer.

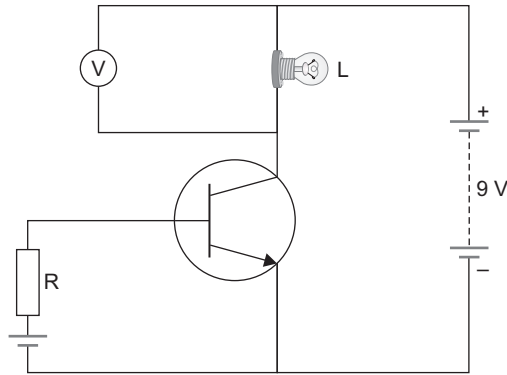

14. (a) An em wave is travelling in a medium with a velocity $v = v\hat{i}$. Draw a sketch showing the propagation of the em wave, indicating the direction of the oscillating electric and magnetic fields.
- (b) How are the magnitudes of the electric and magnetic fields related to the velocity of the em wave?
15. Block diagram of a receiver is shown in the figure:

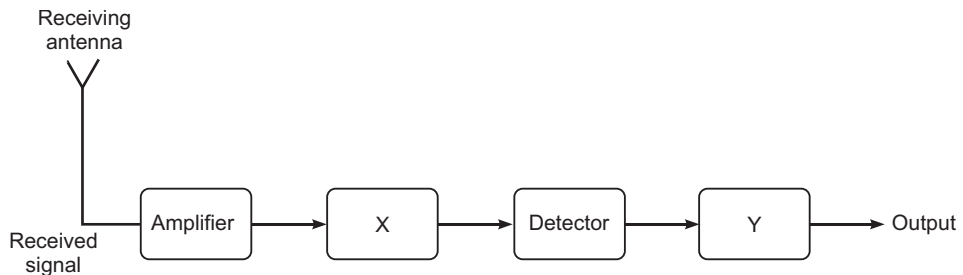

- (a) Identity 'X' and 'Y'.
- (b) Write their functions.
16. Explain, with the help of a circuit diagram, the working of a photo-diode. Write briefly how it is used to detect the optical signals.

OR

Mention the important considerations required while fabricating a p-n junction diode to be used as a Light Emitting Diode (LED). What should be the order of band gap of an LED if it is required to emit light in the visible range?

17. Write three important factors which justify the need of modulating a message signal. Show diagrammatically how an amplitude modulated wave is obtained when a modulating signal is superimposed on a carrier wave.

18. A capacitor of unknown capacitance is connected across a battery of V volts. The charge stored in it is 360 C . When potential across the capacitor is reduced by 120 V , the charge stored in it becomes 120 C .

Calculate:

- The potential V and the unknown capacitance C .
- What will be the charge stored in the capacitor, if the voltage applied had increased by 120 V ?

OR

A hollow cylindrical box of length 1 m and area of cross-section 25 cm^2 is placed in a three dimensional coordinate system as shown in the figure. The electric field in the region is given by

$E = 50x\hat{i}$, where E is in NC^{-1} and x is in metres. Find

- Net flux through the cylinder.
- Charge enclosed by the cylinder.

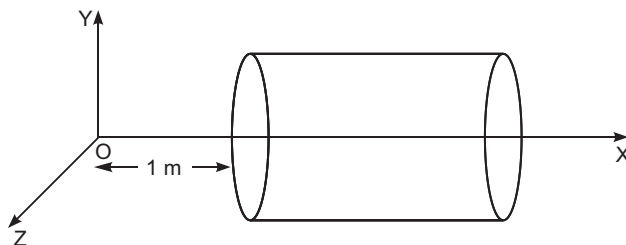

19. (a) In a typical nuclear reaction, e.g.
- $${}^2_1\text{H} + {}^2_1\text{H} \rightarrow {}^3_2\text{He} + \text{n} + 3.27\text{MeV},$$
- although number of nucleons is conserved, yet energy is released. How? Explain.
- (b) Show that nuclear density in a given nucleus is independent of mass number A .
20. (a) Why photoelectric effect can not be explained on the basis of wave nature of light? Give reasons.
- (b) Write the basic features of photon picture of electromagnetic radiation on which Einstein's photoelectric equation is based.
21. A metallic rod of length ' l ' is rotated with a frequency ν with one end hinged at the centre and the other end at the circumference of a circular metallic ring of radius r , about an axis passing through the centre and perpendicular to the plane of the ring. A constant uniform magnetic field B parallel to the axis is present every where. Using Lorentz force, explain how emf is induced between the centre and the metallic ring and hence obtain the expression for it.
22. Output characteristics of an n-p-n transistor in CE configuration is shown in the figure. Determine:
- dynamic output resistance
 - dc current gain and
 - ac current gain at an operating point $V_{\text{CE}} = 10 \text{ V}$, when $I_{\text{B}} = 30 \text{ A}$.

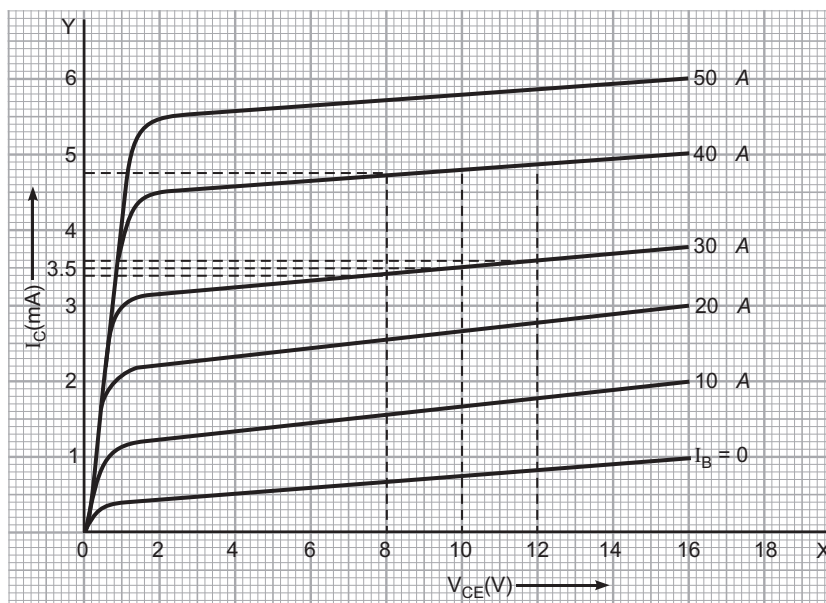

23. Using Bohr's postulates, obtain the expression for the total energy of the electron in the stationary states of the hydrogen atom. Hence draw the energy level diagram showing how the line spectra corresponding to Balmer series occur due to transition between energy levels.
24. (a) In what way is diffraction from each slit related to the interference pattern in a double slit experiment?
- (b) Two wavelengths of sodium light 590 nm and 596 nm are used, in turn, to study the diffraction taking place at a single slit of aperture 2×10^{-4} m. The distance between the slit and the screen is 1.5 m. Calculate the separation between the positions of the first maxima of the diffraction pattern obtained in the two cases.
25. In a series LCR circuit connected to an ac source of variable frequency and voltage $v = v_m \sin \omega t$, draw a plot showing the variation of current (I) with angular frequency (ω) for two different values of resistance R_1 and R_2 ($R_1 < R_2$). Write the condition under which the phenomenon of resonance occurs. For which value of the resistance out of the two curves, a sharper resonance is produced? Define Q-factor of the circuit and give its significance.
26. **While travelling back to his residence in the car, Dr. Pathak was caught up in a thunderstorm. It became very dark. He stopped driving the car and waited for thunderstorm to stop. Suddenly he noticed a child walking alone on the road. He asked the boy to come inside the car till the thunderstorm stopped. Dr. Pathak dropped the boy at his residence. The boy insisted that Dr. Pathak should meet his parents. The parents expressed their gratitude to Dr. Pathak for his concern for safety of the child.**

Answer the following question based on the above information:

- (a) Why is it safer to sit inside a car during a thunderstorm?
- (b) Which two values are displayed by Dr. Pathak in his actions?
- (c) Which values are reflected in parents' response to Dr. Pathak?
- (d) Give an example of a similar action on your part in the past from everyday life.

27. (a) Draw a ray diagram showing the image formation by a compound microscope. Hence obtain expression for total magnification when the image is formed at infinity.
- (b) Distinguish between myopia and hypermetropia. Show diagrammatically how these defects can be corrected.

OR

- (a) State Huygen's principle. Using this principle draw a diagram to show how a plane wave front incident at the interface of the two media gets refracted when it propagates from a rarer to a denser medium. Hence verify Snell's law of refraction.
- (b) When monochromatic light travels from a rarer to a denser medium, explain the following, giving reasons:
- Is the frequency of reflected and refracted light same as the frequency of incident light?
 - Does the decrease in speed imply a reduction in the energy carried by light wave?
28. (a) State the working principle of a potentiometer. With the help of the circuit diagram, explain how a potentiometer is used to compare the emf's of two primary cells. Obtain the required expression used for comparing the emfs.
- (b) Write two possible causes for one sided deflection in a potentiometer experiment.

OR

- (a) State Kirchhoff's rules for an electric network. Using Kirchhoff's rules, obtain the balance condition in terms of the resistances of four arms of Wheatstone bridge.
- (b) In the meterbridge experimental set up, shown in the figure, the null point 'D' is obtained at a distance of 40 cm from end A of the meterbridge wire. If a resistance of 10Ω is connected in series with R_1 , null point is obtained at $AD = 60$ cm. Calculate the value of R_1 and R_2 .

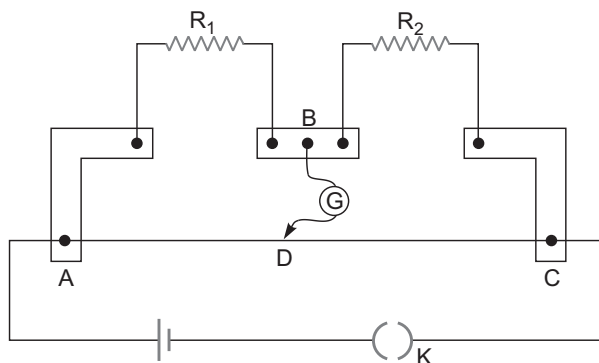

29. (a) Derive the expression for the torque on a rectangular current carrying loop suspended in a uniform magnetic field.
- (b) A proton and a deuteron having equal momenta enter in a region of uniform magnetic field at right angle to the direction of the field. Depict their trajectories in the field.

OR

- (a) A small compass needle of magnetic moment 'm' is free to turn about an axis perpendicular to the direction of uniform magnetic field 'B'. The moment of inertia of the needle about the axis is 'I'. The needle is slightly disturbed from its stable position and then released. Prove that it executes simple harmonic motion. Hence deduce the expression for its time period.

- (b) A compass needle, free to turn in a vertical plane orients itself with its axis vertical at a certain place on the earth. Find out the values of (i) horizontal component of earth's magnetic field and (ii) angle of dip at the place.

SET-II

Questions Uncommon to Set-I

- A cell of emf 'E' and internal resistance 'r' draws a current 'I'. Write the relation between terminal voltage 'V' in terms of E, I and r.
- Which of the following substances are diamagnetic?
Bi, Al, Na, Cu, Ca and Ni
- A heating element is marked 210 V, 630 W. What is the value of the current drawn by the element when connected to a 210 V dc source?
- An ammeter of resistance 1 Ω can measure current upto 1.0 A (i) What must be the value of the shunt resistance to enable the ammeter to measure upto 5.0 A? (ii) What is the combined resistance of the ammeter and the shunt?
- A convex lens of focal length 20 cm is placed coaxially in contact with a concave lens of focal length 25 cm. Determine the power of the combination. Will the system be converging or diverging in nature?
- Using Bohr's postulates, obtain the expression for (i) kinetic energy and (ii) potential energy of the electron in stationary state of hydrogen atom.
Draw the energy level diagram showing how the transitions between energy levels result in the appearance of Lyman Series.
- Figure shows a rectangular loop conducting PQRS in which the arm PQ is free to move. A uniform magnetic field acts in the direction perpendicular to the plane of the loop. Arm PQ is moved with a velocity v towards the arm RS. Assuming that the arms QR, RS and SP have negligible resistances and the moving arm PQ has the resistance r , obtain the expression for (i) the current in the loop (ii) the force and (iii) the power required to move the arm PQ.

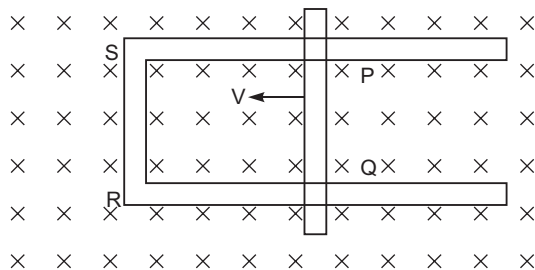

- Distinguish between 'sky waves' and 'space waves' modes of propagation in communication system.
 - Why is sky wave mode propagation restricted to frequencies upto 40 MHz?
 - Give two examples where space wave mode of propagation is used.

SET-III**Questions Uncommon to Set-I and II**

6. A 5 V battery of negligible internal resistance is connected across a 200 V battery and a resistance of 39 Ω as shown in the figure. Find the value of the current.

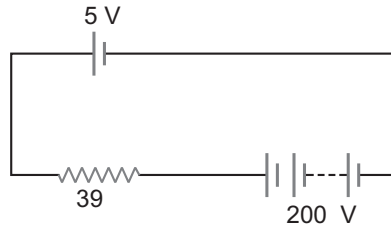

9. An ammeter of resistance 0.6 Ω can measure current upto 1.0 A. Calculate (i) The shunt resistance required to enable the ammeter to measure current upto 5.0 A (ii) The combined resistance of the ammeter and the shunt.
15. A convex lens of focal length 30 cm is placed coaxially in contact with a concave lens of focal length 40 cm. Determine the power of the combination. Will the system be converging or diverging in nature?
19. (a) Write two characteristic features distinguishing the diffraction pattern from the interference fringes obtained in Young's double slit experiment.
 (b) Two wavelengths of sodium light 590 nm and 596 nm are used, in turn, to study the diffraction taking place due to a single slit of aperture 1×10^{-4} m. The distance between the slit and the screen is 1.8 m. Calculate the separation between the positions of the first maxima of the diffraction pattern obtained in the two cases.
21. (a) In a nuclear reaction

$${}^3_2\text{He} + {}^3_2\text{He} \rightarrow {}^4_2\text{He} + {}^1_1\text{H} + {}^1_1\text{H} + 12.86\text{MeV}$$
, though the number of nucleons is conserved on both sides of the reaction, yet the energy is released. How? Explain.
 (b) Draw a plot of potential energy between a pair of nucleons as a function of their separation. Mark the regions where potential energy is (i) positive and (ii) negative.
25. (a) Using Bohr's postulates, obtain the expression for total energy of the electron in the n^{th} orbit of hydrogen atom.
 (b) What is the significance of negative sign in the expression for the energy?
 (c) Draw the energy level diagram showing how the line spectra corresponding to Paschen series occur due to transition between energy levels.



Solutions

CBSE (Delhi) Set-I

1. Substances that retain their ferromagnetic property for a long period of time at room temperature are called permanent magnets.

Examples : Steel, alnico, cobalt and ticonal.

2. Spherical shape with point charges $q > 0$ or $q < 0$ at the centre.
3. (i) Heat waves: As heat waves are transverse or electromagnetic in nature.
4. During charging of a capacitor by a d.c. source,

$$I_c = I_d = \frac{dQ}{dt} = \frac{d}{dt} (C \cdot E)$$

When capacitor is fully charged then $(E) = \text{Max}$

So $I_c = I_d = 0$

5. Angle of incidence $i = \frac{A}{2} = \frac{m}{2}$

Concept : $i + e = A$

But at minimum angle of deviation, $i = e$

6. Pairs of curves for different materials and same intensity radiations are graphs (1, 3) and (2, 4).

Concept : Stopping potential depends on (i) nature of material (ii) frequency of radiation.

7. If cells are in oppositions

$$E_{\text{net}} = E_1 - E_2 \\ = (200 - 10) \text{ V} = 190 \text{ V}$$

$$\text{Current } I = \frac{E_{\text{net}}}{R_{\text{eq}}} = \frac{190}{38} = 5 \text{ A}$$

8. (i) In an open circuit, the emf of a cell and terminal voltage are same.
- (ii) In closed circuit, a current is drawn from the source, so, $V = E - Ir$, it is true/valid, because each cell has some finite resistance.

9. (a) (i) Light ray must travel from denser medium into rarer medium.

(ii) The angle of incidence in denser medium must be greater than the critical angle.

(b) Relation for pair of optical media with refractive indices n_1 and n_2 ($n_2 > n_1$).

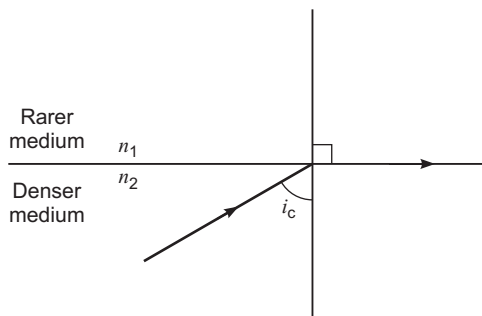

From snell's law $= \frac{\sin i_c}{\sin 90^\circ} = n_{21} = {}_2n_1 = \frac{n_1}{n_2}$

$$\sin i_c = \frac{n_1}{n_2}$$

10. The polarity of the induced emf at the open ends of a closed loop is such that it tends to produce a current which opposes the change in magnetic flux that produced it.



Yes, an *emf* will be induced at its ends.

Justification: As the metallic rod falls down, the magnetic flux due to vertical component of Earth's magnetic field keeps on changing.

11. Convex lens and concave lens are in contact as shown in fig.

$$\begin{aligned} \text{Power of convex lens } P_1 &= \frac{1}{f_1(\text{in m})} = \frac{100}{f_1(\text{in cm})} \\ &= \frac{100}{25} \\ &= 4\text{D} \end{aligned}$$

$$\begin{aligned} \text{Power of convex lens } P_2 &= \frac{1}{f_2} = \frac{100}{20} \\ &= -5\text{D} \end{aligned}$$

$$\begin{aligned} \text{Power of combination } P &= P_1 + P_2 \\ &= 4\text{D} + (-5\text{D}) \\ &= -1\text{D} \end{aligned}$$

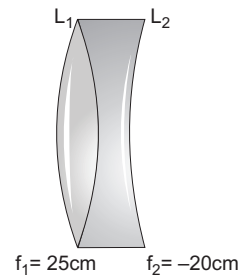

System of lenses is diverging in nature.

12. (i) Fig. shows an ammeter of resistance 0.80 that measure current of 1.0 A.

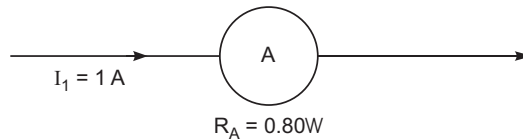

If a shunt 'S' is connected in parallel, a current $(I - I_1)$ flows through 'S'.

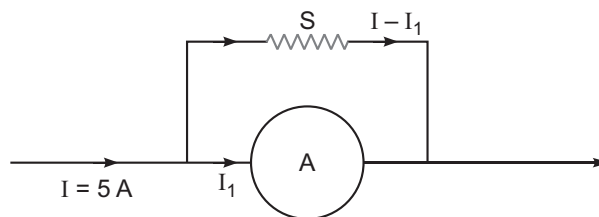

For parallel combination of resistors

$$I_1 \cdot R_A = (I - I_1) S \quad (1/2)$$

$$1 \times 0.80 = (5 - 1) S$$

$$S = \frac{0.8}{4} = 0.2$$

(ii) Combined resistance of the ammeter and the shunt

$$\frac{1}{R} = \frac{1}{R_A} + \frac{1}{S}$$

$$R = \frac{R_A \cdot S}{R_A + S} = \frac{0.8 \cdot 0.2}{0.8 + 0.2}$$

$$= 0.16$$

13. (i) If the value of the resistance R is reduced, the current in the forward biased input circuit increases. The emitter current I_E and the collector current $I_C (= I_E - I_B)$ both increase. Hence, the brightness of the lamp increases.
- (ii) Due to increase in I_C , the potential drop across lamp L increases and hence the voltmeter reading V increases.
14. The direction of propagation of electromagnetic wave is given by $E \times B$

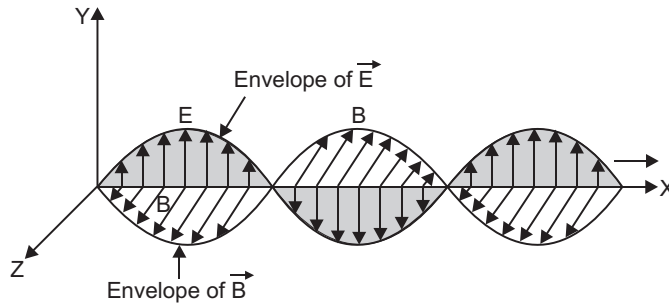

(a) $i = j \times k$. (1)

(b) The speed of electromagnetic wave $|c| = \frac{|E_0|}{|B_0|}$ (1)

15. (a) Box 'x' represents IF stage (intermediate frequency stage)
 Box 'y' represents Amplifier.

(b) Function of IF stage - It changes the electromagnetic wave of high frequency to a lower frequency for further detection in detector.

Function of amplifier - The detected signal may not be strong enough to be made use of, then amplifier is required. Its function is to enhance the power of the signals upto a required level.

16.

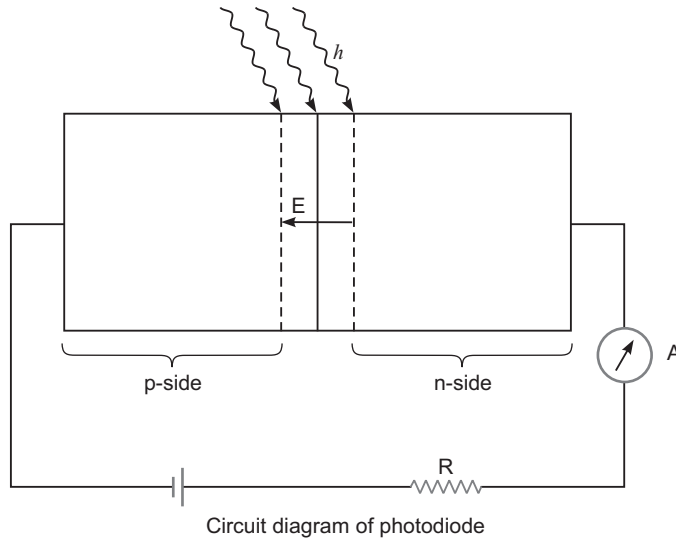

Working: In diode (any type of diode), an electric field 'E' exists across the junction from n-side to p-side, when light with energy h greater than energy gap E_g illuminates the junction. Then electron-hole pairs are generated due to absorption of photons, in or near the depletion region of the diode. Due to existing electric field, electrons and holes get separated. The free electrons are collected on n-side and holes are collected on p-side, giving rise to an emf.

Due to this generated emf, an electric current of A order flows through the external resistance.

Detection of Optical Signals:

It is easier to observe the change in the current with change in the light intensity if a reverse bias is applied. Thus, photodiode can be used as a photodetector to detect optical signals.

OR

Important consideration in the fabrication of LED:

- (a) (i) light emitting diode is a heavily doped p-n junction.
- (ii) The reverse breakdown voltages of LEDs are very low, typically around 5V.
- (b) The order of band gap of an LED to emit light in the visible range is about 3 eV to 1.8 eV.

17. Three factors for the need of modulating a message signal:

- (i) Size of the antenna or aerial: about $\frac{\lambda}{4}$
- (ii) Effective power radiated by an antenna: Proportional to $\frac{\ell^2}{\lambda^2}$
- (iii) Mixing up of signals from different transmitters.

Diagrammatic representation:

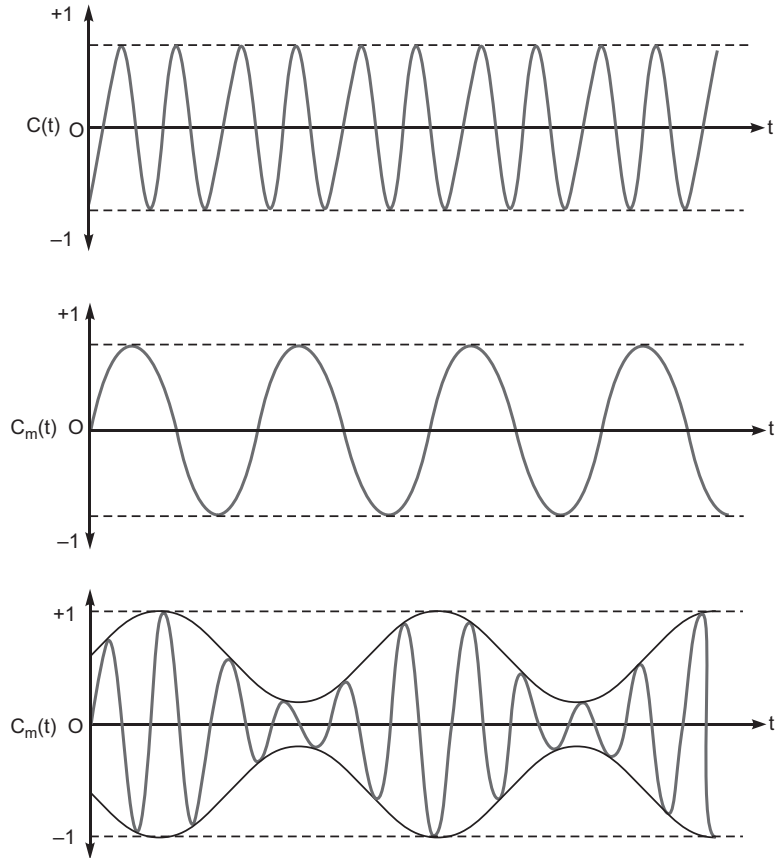

18.

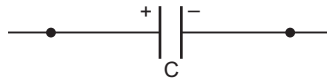

- (i) If unknown capacitor of capacitance 'C' is connected to a battery of 'V' volts,

$$Q = CV$$

$$CV = 360 \text{ C} \quad (1)$$

On reducing the potential/voltage by 120V

So, $Q = C(V - 120)$

$$C(V - 120) = 120 \text{ C} \quad (2)$$

On solving equation (1) and (2)

$$\frac{360 \text{ C}}{V} = \frac{120 \text{ C}}{V - 120}$$

$$V = 180\text{V}$$

Unknown capacitance from equation (1)

$$Q = CV$$

$$360 \text{ C} = C \times 180\text{V}$$

$$C = \frac{360 \text{ C}}{180\text{V}} = 2$$

$$C = 2 \text{ F}$$

(ii) Charge on the capacitor, if voltage is increased by 120V

$$Q = C (V + 120)$$

$$= 2 (180 + 120)$$

$$Q = 600 \text{ C}$$

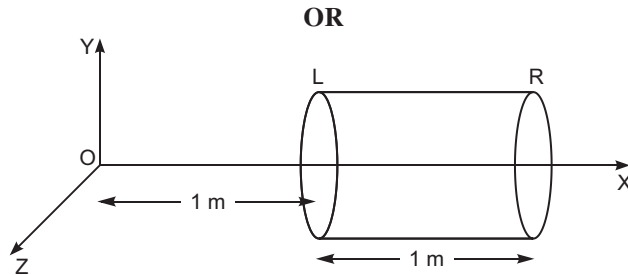

(i) Electric flux through a surface = $E \cdot S$

$$\begin{aligned} \text{Flux through the left surface } L &= -|E| |S| \\ &= -50x \cdot |S| \end{aligned}$$

Since $x = 1\text{m}$,

$$\begin{aligned} L &= -50 \times 1 \times 25 \times 10^{-4} \\ &= -1250 \times 10^{-4} \\ &= -0.125 \text{Nm}^2 \text{C}^{-1} \end{aligned}$$

Flux through the right surface

$$R = |E| |S|$$

Since $x = 2\text{m}$,

$$\begin{aligned} R &= 50x |S| \\ &= 50 \times 2 \times 25 \times 10^{-4} \\ &= 2500 \times 10^{-4} \\ &= 0.250 \text{Nm}^2 \text{C}^{-1} \end{aligned}$$

Net flux through the cylinder

$$\begin{aligned} \text{net} &= R + L \\ &= 0.250 - 0.125 \\ &= 0.125 \text{Nm}^2 \text{C}^{-1} \end{aligned}$$

(ii) Charge inside the cylinder, by Gauss's Theorem

$$\begin{aligned} \text{net} &= \frac{q}{\epsilon_0} \\ &= q = \epsilon_0 \text{Net} \\ &= 8.854 \times 10^{-12} \times 0.125 \\ &= 8.854 \times 10^{-12} \times \frac{1}{8} \\ &= 1.107 \times 10^{-12} \text{C} \end{aligned}$$

19. (a) In nuclear reaction

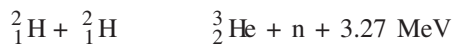

Cause of the energy released:

- (i) Binding energy per nucleon of ${}^3_2\text{He}$ becomes more than the (BE/A) of ${}^2_1\text{H}$.
(ii) Mass defect between the reactant and product nuclei

$$\begin{aligned} E &= mC^2 \\ &= 2m({}^2_1\text{H}) - m({}^3_2\text{He}) - m(\text{n}) \quad C^2 \end{aligned}$$

- (b) The radius of nucleus of mass number A is given by $R = R_0A^{1/3}$

$$\text{Volume of the nucleus } V = \frac{4}{3} R^3 = \frac{4}{3} R_0^3 A$$

Density of the matter in the nucleus

$$\begin{aligned} \frac{\text{Mass}}{\text{Volume}} &= \frac{A(u)}{\frac{4}{3} R_0^3 A} \\ \frac{1}{\frac{4}{3} R_0^3} &= \frac{3}{4 R_0^3} \end{aligned}$$

The expression of the density is independent of mass number A.

20. (a) The observed characteristics of photoelectric effect could not be explained on the basis of wave theory of light due to the following reasons.

- (i) According to wave theory, the light propagates in the form of wavefronts and the energy is distributed uniformly over the wavefronts. With increase of intensity of light, the amplitude of waves and the energy stored by waves will increase. These waves will then, provide more energy to electrons of metal; consequently, the energy of electrons will increase.

Thus, according to wave theory, the kinetic energy of photoelectrons must depend on the intensity of incident light; but according to experimental observations, the kinetic energy of photoelectrons does not depend on the intensity of incident light.

- (ii) According to wave theory, the light of any frequency can emit electrons from metallic surface provided the intensity of light be sufficient to provide necessary energy for emission of electrons, but according to experimental observations, the light of frequency less than threshold frequency cannot emit electrons; whatever the intensity of incident light may be.
- (iii) According to wave theory, the energy transferred by light waves will not go to a particular electron, but it will be distributed uniformly to all electrons present in the illuminated surface. Therefore, electrons will take some time to collect the necessary energy for their emission. The time for emission will be more for light of less intensity and vice versa. But experimental observations show that the emission of electrons take place instantaneously after the light is incident on the metal; whatever the intensity of light may be.

(b) Features of the photons:

- (i) Photons are particles of light having energy $E = h\nu$ and momentum $p = \frac{h\nu}{c}$, where h is planck constant.
- (ii) Photons travel with the speed of light in vacuum, independent of the frame of reference.
- (iii) Intensity of light depends on the number of photons crossing unit area in a unit time.

21. As the rod is rotated, free electrons in the rod move towards the outer end due to Lorentz force and get distributed over the ring. Thus, the resulting separation of charges produces an emf across the ends of the rod. At a certain value of emf, there is no more flow of electrons and a steady state is reached.

Expression for Induced emf in a Rotating Rod

Consider a metallic rod OA of length l , which is rotating with angular velocity ω in a uniform magnetic field B , the plane of rotation being perpendicular to the magnetic field. A rod may be supposed to be formed of a large number of small elements. Consider a small element of length dx at a distance x from centre. If v is the linear velocity of this element, then area swept by the element per second $v dx$

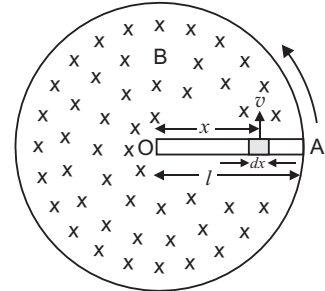

The emf induced across the ends of element

$$d\epsilon = B \frac{dA}{dt} = B v dx$$

But $v = \omega x$

$$d\epsilon = B \omega x dx$$

The emf induced across the rod

$$\epsilon = \int_0^l B \omega x dx = B \omega \int_0^l x dx$$

$$= B \omega \left[\frac{x^2}{2} \right]_0^l = B \omega \frac{l^2}{2} = \frac{1}{2} B \omega l^2$$

Current induced in rod $I = \frac{\epsilon}{R} = \frac{1}{2} \frac{B \omega l^2}{R}$

If circuit is closed, power dissipated,

$$P = \frac{\epsilon^2}{R} = \frac{B^2 \omega^2 l^4}{4R}$$

22. (i) Dynamic output resistance is given by

$$r_o = \frac{V_{CE}}{I_C}$$

For $I_B = 30 \mu A$, $V_{CE} = (12 - 8) = 4V$ and $I_C = (3.6 - 3.4) = 0.2mA$

$$r_o = \frac{4V}{0.2 \text{ mA}} = \frac{4}{0.2 \times 10^{-3}} = 2 \times 10^4 \text{ ohm}$$

(ii) dc current gain

$$\beta_{dc} = \frac{I_C}{I_B}$$

At $V_{CE} = 10 V$ and $I_B = 30 \mu A$, the value of $I_C = 3.5mA$

$$d_c = \frac{3.5 \text{ mA}}{30 \text{ A}} = \frac{3.5}{30} \frac{10^3}{10^6}$$

$$d_c = 117$$

(iii) ac current gain

$$d_c = \frac{C}{B V_{CE}}$$

$$\text{At } V_{CE} = 10 \text{ V, } I_C = (3.5 - 2.5) \text{ mA} = 1 \text{ mA}$$

$$\text{and } I_B = (30 \text{ A} - 20 \text{ A}) = 10 \text{ A}$$

$$d_c = \frac{1 \text{ A}}{10 \text{ A}} = 100$$

23. Suppose m be the mass of an electron and v be its speed in n th orbit of radius r . The centripetal force for revolution is produced by electrostatic attraction between electron and nucleus.

$$\frac{mv^2}{r} = \frac{1}{4\pi\epsilon_0} \frac{(Ze)(e)}{r^2} \quad \dots (i)$$

or,
$$mv^2 = \frac{1}{4\pi\epsilon_0} \frac{Ze^2}{r}$$

So, Kinetic energy $[K] = \frac{1}{2}mv^2$

$$K = \frac{1}{4\pi\epsilon_0} \frac{Ze^2}{2r}$$

$$\text{Potential energy} = \frac{1}{4\pi\epsilon_0} \frac{(Ze)(-e)}{r} = -\frac{1}{4\pi\epsilon_0} \frac{Ze^2}{r}$$

Total energy,

$$E = KE + PE = \frac{1}{4\pi\epsilon_0} \frac{Ze^2}{2r} - \frac{1}{4\pi\epsilon_0} \frac{Ze^2}{r}$$

$$E = -\frac{1}{4\pi\epsilon_0} \frac{Ze^2}{2r}$$

For n th orbit, E can be written as E_n

so,
$$E_n = -\frac{1}{4\pi\epsilon_0} \frac{Ze^2}{2r_n} \quad \dots (ii)$$

Again from Bohr's postulate for quantization of angular momentum.

$$mvr = \frac{nh}{2\pi} \quad v = \frac{nh}{2\pi mr}$$

Substituting this value of v in equation (i), we get

$$\frac{m}{r} \left(\frac{nh}{2\pi mr} \right)^2 = \frac{1}{4\pi\epsilon_0} \frac{Ze^2}{r^2}$$

or,
$$r = \frac{0.529 \times 10^{-10} n^2}{Z}$$

or,
$$r_n = \frac{0.529 \times 10^{-10} n^2}{Z} \quad \dots(iii)$$

Substituting value of r_n in equation (ii), we get

$$E_n = \frac{1}{4} \times \frac{Ze^2}{2} \times \frac{mZ^2e^4}{8 \times 0.529^2 \times 10^{-20} n^2}$$

or,
$$E_n = \frac{Z^2 R h c}{n^2}, \text{ where } R = \frac{me^4}{8 \times 0.529^2 \times 10^{-20} \times ch^3}$$

R is called Rydberg constant.

For hydrogen atom $Z = 1$,

$$E_n = \frac{R h c}{n^2}$$

For Balmer series $n_f = 2$, while $n_i = 3, 4, 5, \dots$

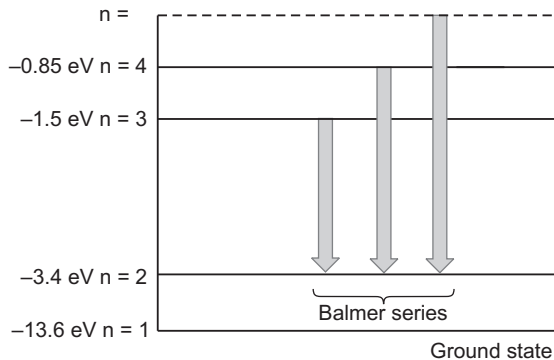

Energy level diagram of Balmer series

24. (a) When a plane wavefront of monochromatic light illuminates, the slit LN, each point in the slit LN becomes the source of secondary wavelets.

The secondary wavelets originating from different points superpose on each, while travelling towards the point C and point P; at angle θ . However the superposition of the secondary wavelets produces a diffraction pattern of varying intensity, as shown in fig.

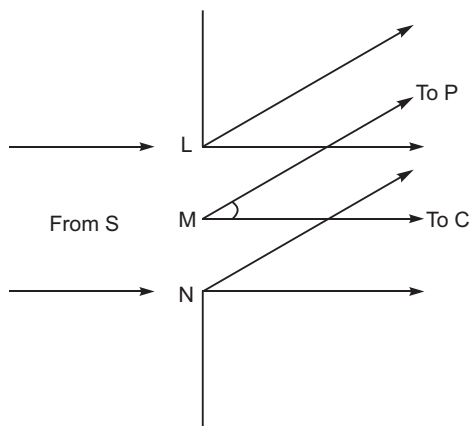

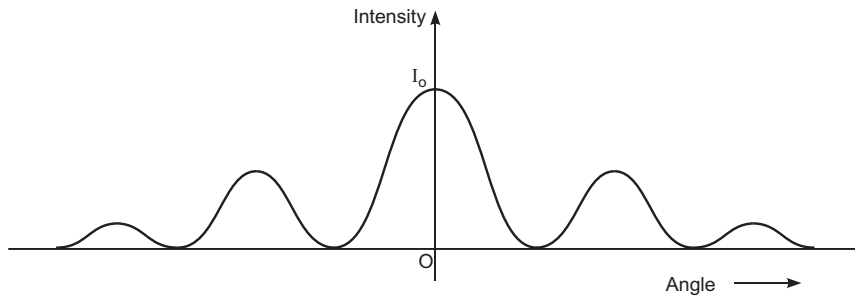

(b) For maxima other than central maxima

$$a. \quad = n \frac{1}{2}$$

$$\text{and} \quad = \frac{y}{D}$$

$$a. \frac{y}{D} = n \frac{1}{2}$$

For light of wavelength $\lambda_1 = 590 \text{ nm}$

$$2 \times 10^{-4} \frac{y_1}{1.5} = 1 \frac{1}{2} \times 590$$

$$y_1 = \frac{3}{2} \times \frac{590 \times 10^{-9} \times 1.5}{2 \times 10^{-4}}$$

$$= 6.64 \text{ mm}$$

For light of wavelength $\lambda_2 = 596 \text{ nm}$

$$2 \times 10^{-4} \frac{y_2}{1.5} = 1 \frac{1}{2} \times 596$$

$$y_2 = \frac{3}{2} \times \frac{596 \times 10^{-9} \times 1.5}{2 \times 10^{-4}}$$

$$= 6.705 \text{ mm}$$

Separation between two positions of first maxima

$$\begin{aligned} y &= y_2 - y_1 \\ &= 6.705 - 6.64 \\ &= 0.065 \text{ mm} \end{aligned}$$

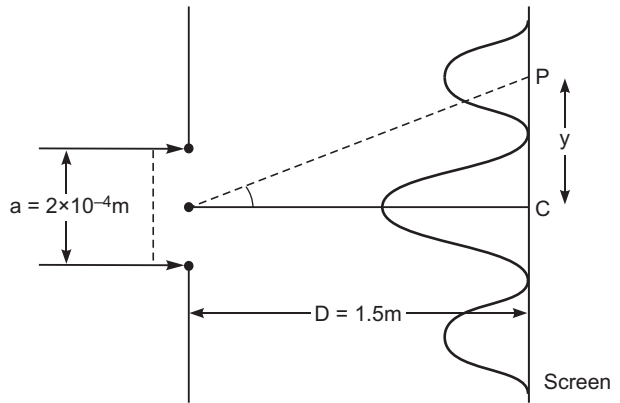

25.

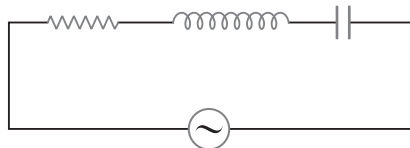

At certain frequency, the flow of current through the series combination

$$I_m = \frac{v_m}{\sqrt{R^2 + (X_L - X_C)^2}}$$

Where $X_L = \omega L$ and $X_C = \frac{1}{\omega C}$

Condition of resonance – If system (LCR) of natural frequency ω_0 is driven by an energy source at a frequency ω , the amplitude of the current flow increases, however the amplitude of the current rises to its maximum value, if frequency of the energy source becomes exactly equal to the natural frequency.

For resistance $R_2 > R_1$, series LCR shows a sharp resonance.

Q-factor – The ratio of reactance (either inductive or capacitive) at natural frequency to the resistance of the current is called Q factor.

$$Q = \frac{X_L}{R} = \frac{\omega_0 L}{R}$$

Significance: (i) If resistance R is low or inductance L is large then Q – factor is large and the circuit is more selective.

(ii) If resonance is less sharp, tuning of the circuit will not be good.

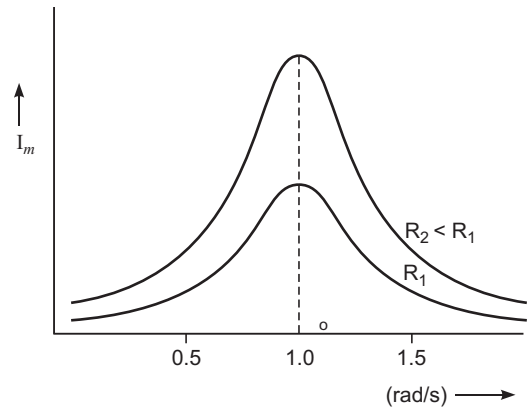

26. (a) On the basis of electrostatic screening, no electric field exists inside the charged conducting body. During lightning a shower of the charged particles falls on the earth. So it would be safer to sit inside the car.
- (b) Dr. Pathak knows the result of lightning during thunderstorm; so he displayed two actions;
- Shows love, kindness and sympathy to the child.
 - Keeping in view the safety of the child, he allow the boy to sit in the car till the thunderstorm stopped.
- (c) Parent meets Dr. Pathak; and express their gratitude and heart felt thank for providing the safety to the child from lightning and thunderstorm.
- (d) Many of us have read in the newspaper that the person either working in the field or in open space have lost their life during thunderstorm, so the persons belonging to villages must be given advices that they should remain inside the houses (or closed caves etc.) during thunderstorm.
27. (a) Difference between myopia and hypermetropia

Myopia	Hypermetropia
1. The eye ball is elongated.	1. The eye ball is shortened.
2. Person cannot see distant objects clearly.	2. Person cannot see near objects clearly.

- Myopia eye is corrected by interposing a concave lens between eye and object.
- Hypermetropia is corrected by interposing a convex lens between eye and object.

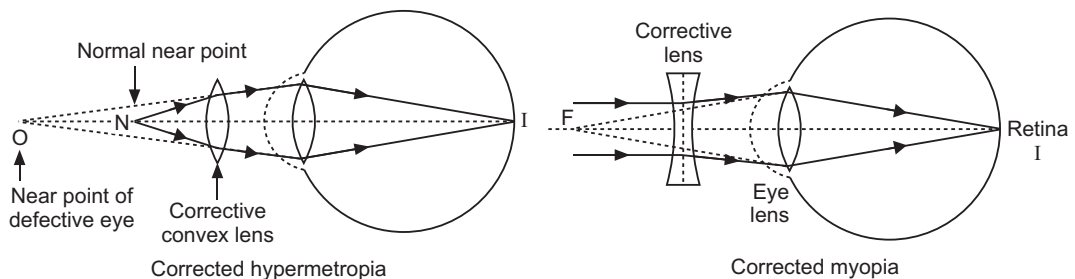

- (b) If image $A'B'$ is exactly at the focus of the eyepiece, then image $A'B'$ is formed at infinity.
 If the object AB is very close to the focus of the objective lens of focal length f_o , then magnification M_o by the objective lens

$$M_o = \frac{L}{f_o}$$

where L is tube length (or distance between lenses L_o and L_e)

Magnification M_e by the eyepiece

$$M_e = \frac{D}{f_e}$$

where D = Least distance of distinct vision

$$\begin{aligned} \text{Total magnification } m &= M_o M_e \\ &= \frac{L}{f_o} \frac{D}{f_e} \end{aligned}$$

OR

- (a) **Law of Reflection :** Let XY be a reflecting surface at which a wavefront is being incident obliquely. Let v be the speed of the wavefront and at time $t = 0$, the wavefront touches the surface XY at A . After time t , the point B of wavefront reaches the point B' of the surface.

According to Huygen's principle each point of wavefront acts as a source of secondary waves. When the point A of wavefront strikes the reflecting surface, then due to presence of reflecting surface, it cannot advance further; but the secondary wavelet originating from point A begins to spread in all directions in the first medium with speed v . As the wavefront AB advances further, its points $A_1, A_2, A_3 \dots$ etc. strike the reflecting surface successively and send spherical secondary wavelets in the first medium.

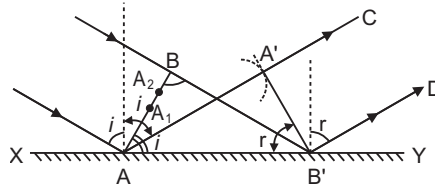

First of all the secondary wavelet starts from point A and traverses distance AA' ($= vt$) in first medium in time t . In the same time t , the point B of wavefront, after travelling a distance BB' , reaches point B' (of the surface), from where the secondary wavelet now starts. Now taking A as centre we draw a spherical arc of radius AA' ($= vt$) and draw tangent $A'B'$ on this arc from point B' . As the incident wavefront AB advances, the secondary wavelets starting from points between A and B' , one after the other and will touch $A'B'$ simultaneously. According to Huygen's principle wavefront $A'B'$ represents the new position of AB , i.e., $A'B'$ is the reflected wavefront corresponding to incident wavefront AB .

Now in right-angled triangles ABB' and $AA'B'$

$$\angle ABB' = \angle AA'B' \quad (\text{both are equal to } 90^\circ)$$

$$\text{side } BB' = \text{side } AA' \quad (\text{both are equal to } vt)$$

and side AB' is common

i.e., both triangles are congruent.

$$\triangle B A B' \cong \triangle A B' A$$

i.e., incident wavefront AB and reflected wavefront $A'B'$ make equal angles with the reflecting surface XY . As the rays are always normal to the wavefront, therefore the incident and the reflected rays make equal angles with the normal drawn on the surface XY , *i.e.*,

$$\text{angle of incidence } i = \text{angle of reflection } r$$

This is the second law of reflection.

Since AB , $A'B'$ and XY are all in the plane of paper, therefore the perpendiculars dropped on them will also be in the same plane. Therefore we conclude that **the incident ray, reflected ray and the normal at the point of incidence, all lie in the same plane.** This is the first law of reflection. Thus Huygen's principle explains both the laws of reflection.

- (b) (i) If the radiation of certain frequency interact with the atoms/molecules of the matter, they start to vibrate with the same frequency under forced oscillations.

Thus, the frequency of the scattered light (Under reflection and refraction) equals to the frequency of incident radiation.

- (ii) No, energy carried by the wave depends on the amplitude of the wave, but not on the speed of the wave.

28. (a) Working Principle of Potentiometer

Principle. Consider a long resistance wire AB of uniform cross-section. Its one end A is connected to the positive terminal of battery B_1 whose negative terminal is connected to the other end B of the wire through key K and a rheostat (Rh). The battery B_1 connected in circuit is called the driver battery and this circuit is called the **primary circuit**. By the help of this circuit a definite potential difference is applied across the wire AB ; the potential falls continuously along the wire from A to B . **The fall of potential per unit length of wire is called the potential gradient.** It is denoted by ' k '. A cell is connected such that its positive terminal is connected to end A and the negative terminal to a jockey J through the galvanometer G . This circuit is called the **secondary circuit**.

In primary circuit the rheostat (Rh) is so adjusted that the deflection in galvanometer is on one side when jockey is touched on wire at point A and on the other side when jockey is touched on wire at point B .

The jockey is moved and touched to the potentiometer wire and the position is found where galvanometer gives no deflection. Such a point P is called **null deflection point**.

V_{AB} is the potential difference between points A and B and L metre be the length of wire, then the potential gradient

$$k = \frac{V_{AB}}{L}$$

If the length of wire AP in the null deflection position be l , then the potential difference between points A and P ,

$$V_{AP} = kl$$

The emf of cell, $V_{AP} = kl$

In this way the emf of a cell may be determined by a potentiometer.

Comparison of emf's of two cells: First of all the ends of potentiometer are connected to a battery B_1 , key K and rheostat Rh such that the positive terminal of battery B_1 is connected to end A of the wire. This completes the primary circuit.

Now the positive terminals of the cells C_1 and C_2 whose emfs are to be compared are connected to A and the negative terminals to the jockey J through a two-way key and a galvanometer (fig). This is the secondary circuit.

Method: (i) By closing key K , a potential difference is established and rheostat is so adjusted that when jockey J is made to touch at ends A and B of wire, the deflection in galvanometer is on both sides. Suppose in this position the potential gradient is k .

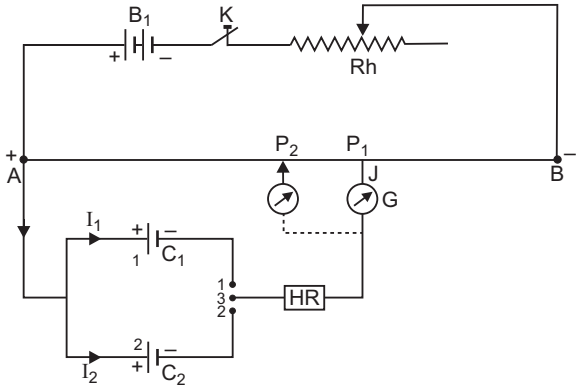

(ii) Now plug is inserted between the terminals 1 and 3 so that cell C_1 is included in the secondary circuit and jockey J is slid on the wire at P_1 (say) to obtain the null point. The distance of P_1 from A is measured. Suppose this length is l_1 i.e. $AP_1 = l_1$

$$\text{The emf of cell } C_1, \quad \frac{1}{2} kl_1 \quad \dots(i)$$

(iii) Now plug is taken off between the terminals 1 and 3 and inserted in between the terminals 2 and 3 to bring cell C_2 in the circuit. Jockey is slid on wire and null deflection position P_2 is noted. Suppose distance of P_2 from A is l_2 i.e. $AP_2 = l_2$

$$\text{The emf of cell } C_2, \quad \frac{2}{2} kl_2 \quad \dots(ii)$$

$$\text{Dividing (i) by (ii), we get} \quad \frac{\frac{1}{2} kl_1}{\frac{2}{2} kl_2} \quad \dots(iii)$$

Thus emf's of cells may be compared. Out of these cells if one is standard cell, then the emf of other cell may be calculated.

(b) Possible causes for one side deflection:

- (i) If emf (ϵ_2) is more than the emf driver cell (auxiliary battery), then we have one sided deflection.
- (ii) when the positive end of the potentiometer wire is connected to negative terminal of the cell whose emf is to be determined.

OR

(a) Kirchhoff's Rule

- (i) At any junction, the sum of the currents entering the junction is equal to the sum of the currents leaving the junction.
- (ii) The algebraic sum of the charges in potential around any closed loop involving resistors and cells in the loop is zero.

Condition of balance of a Wheatstone bridge:

The circuit diagram of Wheatstone bridge is shown in fig.

P , Q , R and S are four resistance forming a closed bridge, called Wheatstone bridge. A battery is connected across A and C , while a galvanometer is connected between B and D . At balance, there is no current in galvanometer.

Derivation of Formula: Let the current given by battery in the balanced position be I . This current on reaching point A is divided into two parts I_1 and I_2 . As

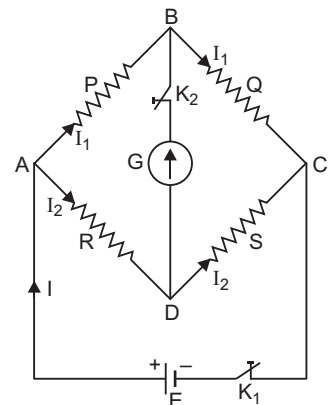

there is no current in galvanometer in balanced state, current in resistances P and Q is I_1 and in resistances R and S it is I_2 .

Applying Kirchhoff's I law at point A

$$I = I_1 + I_2 = 0 \text{ or } I = I_1 + I_2 \dots(i)$$

Applying Kirchhoff's II law to closed mesh ABDA

$$I_1 P - I_2 R = 0 \text{ or } I_1 P = I_2 R \dots(ii)$$

Applying Kirchhoff's II law to mesh BCDB

$$I_1 Q - I_2 S = 0 \text{ or } I_1 Q = I_2 S \dots(iii)$$

Dividing equation (ii) by (iii), we get

$$\frac{I_1 P}{I_1 Q} = \frac{I_2 R}{I_2 S} \text{ or } \frac{P}{Q} = \frac{R}{S} \dots(iv)$$

This is the **condition of balance of Wheatstone bridge.**

(b)

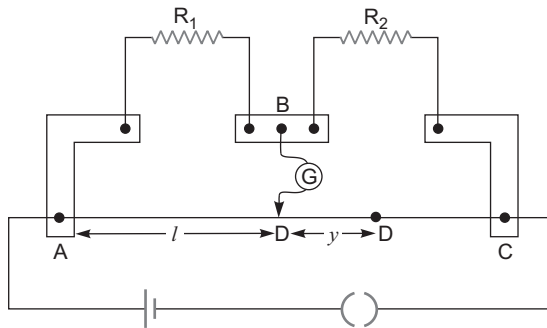

For null point at D, balance length $l_1 = 40$ cm

$$\text{So, } \frac{R_1}{R_2} = \frac{AD}{DC} = \frac{40}{100 - 40} = \frac{2}{3} \dots(1)$$

If resistance 10 is connected in series of R_1 , then balance length AD > AD i.e. balance point shifts by length 'y' towards C i.e., AD = 60 cm.

$$\frac{R_1 + 10}{R_2} = \frac{AD}{DC} = \frac{60}{100 - 60} = \frac{3}{2}$$

$$\frac{R_1}{R_2} + \frac{10}{R_2} = \frac{3}{2} \dots(2)$$

From equations (1) and (2), we have

$$\frac{2}{3} + \frac{10}{R_2} = \frac{3}{2}$$

$$\frac{10}{R_2} = \frac{3}{2} - \frac{2}{3} = \frac{9 - 4}{6} = \frac{5}{6}$$

$$R_2 = \frac{10 \cdot 6}{5} = 12 \text{ ohm}$$

From equation (1), we have

$$\frac{R_1}{12} = \frac{2}{3} \qquad R_1 = \frac{12 \cdot 2}{3} = 8 \text{ ohm}$$

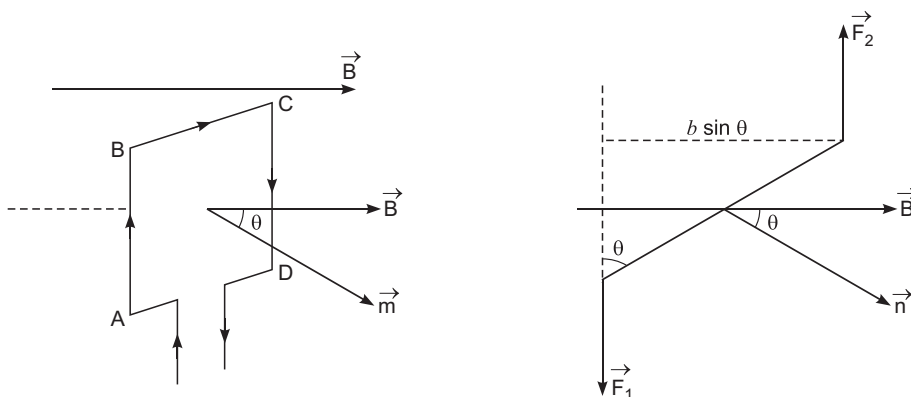
29 (a)

A rectangular loop ABCD of dimensions ℓ and b , carrying a steady current is placed in uniform magnetic field as shown in fig; such that normal of the plane is at angle θ with the magnetic field lines.

The force F_{BC} and F_{AD} on arms BC and AD are equal, opposite and along the axis of the coil, so they cancel each other.

The forces F_{AB} and F_{CD} are also equal and opposite, but are not collinear, so they constitute a couple, and the magnitude of the torque can be given as

$$= F_{AB} \cdot \frac{b}{2} \sin \theta + F_{CD} \cdot \frac{b}{2} \sin \theta$$

$$\begin{aligned} \text{Since } |F_{AB}| &= |F_{CD}| = BI\ell \\ &= BI\ell \times b \sin \theta \\ &= BI (\ell b) \sin \theta \\ &= BI A \sin \theta \end{aligned}$$

$$[A = \ell b = \text{area of the rectangle}]$$

$$\begin{aligned} \text{Since magnetic moment } m &= I |A| \\ &= mB \sin \theta \end{aligned}$$

In vector form $\vec{m} \times \vec{B}$

- (b) If a charge particle enters right angle to the direction of magnetic field, it follows a circular trajectory, and radius can be given as

$$\begin{aligned} qv &= \frac{mv}{r} \\ r &= \frac{mv}{qB} = \frac{P}{qB} \end{aligned}$$

Since momentum are equal, and they have equal charges.

$$\text{So, } r_p : r_d = 1:1$$

OR

- (a) If magnetic compass of dipole moment \vec{m} is placed at angle θ in uniform magnetic field, and released it experiences a restoring torque.

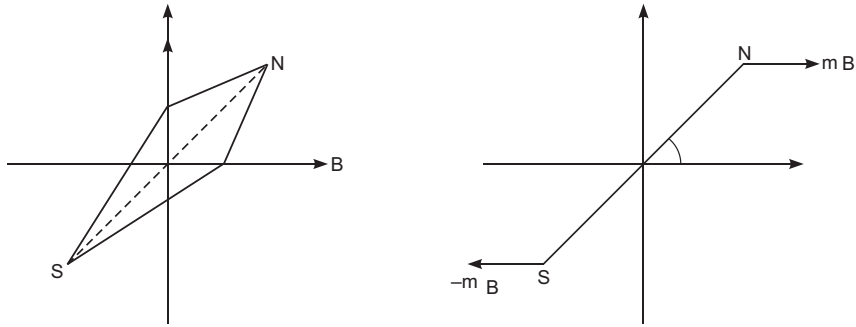

$$\begin{aligned}
 \tau &= - \text{magnetic force} \times \text{perpendicular distance} \\
 &= - |mB| \cdot (2a \sin \theta) \\
 \tau &= - m B
 \end{aligned}$$

where m = pole strength
 $\tau = - m |B| \sin \theta$

In equilibrium, the equation of motion,

$$I \frac{d^2 \theta}{dt^2} = - |m| |B| \sin \theta \quad (\text{For small angle } \sin \theta \approx \theta)$$

$$\frac{d^2 \theta}{dt^2} = - \frac{|M| |B|}{I} \theta$$

$$\frac{d^2 \theta}{dt^2} = - \frac{MB}{I} \theta$$

Since $\frac{d^2 \theta}{dt^2} \propto -\theta$

It represents the simple harmonic motion with angular frequency

$$\omega = \sqrt{\frac{|M| |B|}{I}}$$

$$T = 2\pi \sqrt{\frac{I}{MB}}$$

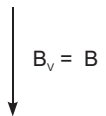

(b) If compass needle orients itself with its axis vertical at a place, then

(i) $B_H = 0$ because $B_V = |B|$

(ii) Angle of dip $= 90^\circ$,

$$\tan \theta = \frac{B_V}{B_H}$$

Angle $\theta = 90^\circ$.

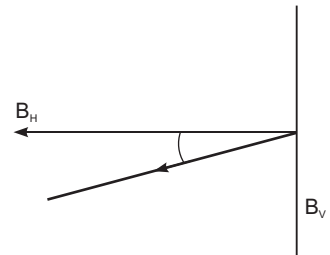

Concept It is possible only on magnetic north or south poles.

CBSE (Delhi) Set-II

Questions uncommon to Set-I

1. The terminal voltage $V < E$, so $V = E - Ir$

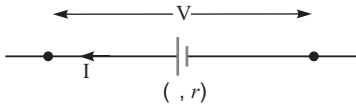

2. Diamagnetic substances are (i) Bi (ii) Cu.
 3. If marked voltage is equal to the voltage of the source, then on element.

$$P = VI$$

$$630 = 210 \times I$$

$$I = \frac{630}{210} = 3A$$

10.

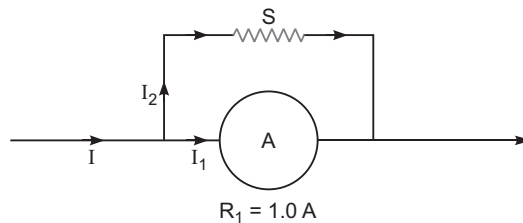

(i) From Ohm's Law $I_1 R_1 = (I_2 - I_1) S$

$$1 \times 1 = (5 - 1) \times S$$

$$S = \frac{1}{4} = 0.25$$

(ii) Combined resistance, $R_{eq} = \frac{S R_1}{S + R_1}$

$$R_{eq} = \frac{0.25 \times 1}{0.25 + 1} = \frac{1}{5} = 0.2$$

14. Power of convex lens, $P_1 = \frac{1}{f(\text{in m})} = \frac{100}{f(\text{in cm})}$

$$P = \frac{100}{20} = 5D$$

Power of concave lens, $P_2 = \frac{100}{f(\text{in m})} = \frac{100}{25} = -4D$

Power of the combination, $P = P_1 + P_2$

$$= 5D + (-4D)$$

$$= 1D$$

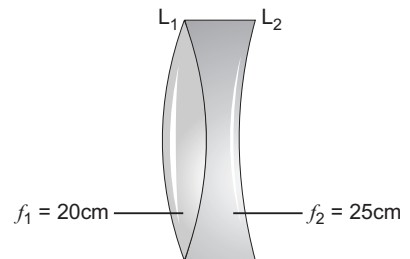

The value of power of combination is positive, so the system acts as converging lens in nature.

19. If electron moves on a circular path of radius r , with speed v as shown in fig.

$$\frac{1}{4\pi\epsilon_0} \cdot \frac{e^2}{r^2} = \frac{mv^2}{r}$$

$$\frac{1}{4\pi\epsilon_0} \cdot \frac{e^2}{r} = mv^2 \tag{1}$$

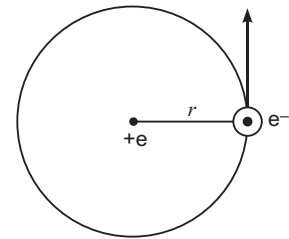

From Bohr's postulate

$$mvr = \frac{nh}{2\pi} \tag{2}$$

From equation (1) and (2), we have

$$v = \frac{mv^2 r}{mvr} = \frac{\frac{e^2}{4\pi\epsilon_0}}{\frac{nh}{2\pi}} = \frac{e^2}{2nh_0}$$

So the KE of the electron

$$K = \frac{1}{2} m v^2 = \frac{1}{2} m \left(\frac{e^2}{2nh_0} \right)^2$$

$$K = \frac{me^4}{8n^2 h^2 \epsilon_0^2}$$

The potential energy of the electron

$$U = \frac{1}{4\pi\epsilon_0} \cdot \frac{e(-e)}{r} = -\frac{1}{4\pi\epsilon_0} \cdot \frac{e^2}{r} \tag{3}$$

From equation (1) and (3)

$$U = -m v^2 = -m \left(\frac{e^2}{2nh_0} \right)^2 = -\frac{me^4}{4n^2 h^2 \epsilon_0^2}$$

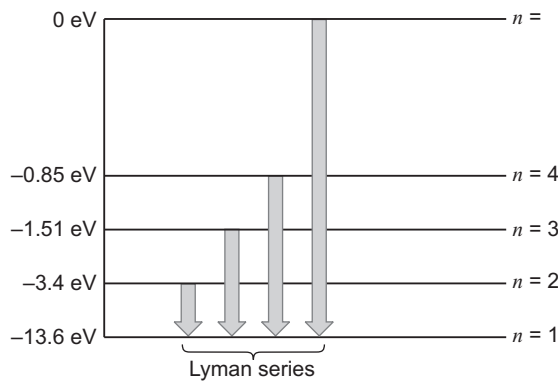

22. (i) Current in the loop PQRS,

$$I = \frac{v}{r}$$

Since $\frac{d\phi}{dt} = B\ell v$ So, $I = \frac{B\ell v}{r}$

- (ii) The force required to keep the arm PQ in constant motion

$$F = BI\ell$$

$$= B \frac{B\ell v}{r} \ell$$

$$F = \frac{B^2 \ell^2 v}{r}$$

- (iii) Power required to move the arm PQ

$$P = |F| |v|$$

$$= \frac{B^2 \ell^2 v}{r} |v|$$

$$= \frac{B^2 \ell^2 v^2}{r}$$

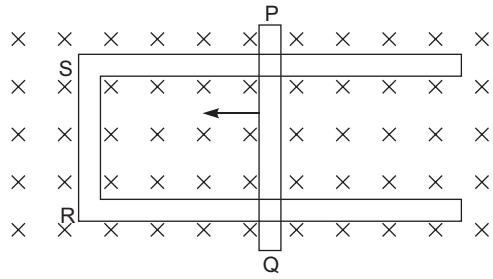

23. Sky wave — Sky wave propagation can be achieved by ionospheric reflection of radio waves back towards the earth, in the frequency range from few MHz up to 30 to 40 MHz.

Space wave — In this mode of propagation, radio wave travels in a straight line from transmitting antenna to the receiving antenna.

- (a) Sky wave propagation is restricted to frequency upto 40 MHz, because the radio waves of frequencies more than 40 MHz penetrates into the ionosphere.
- (b) Space wave propagation (LOS) is used in
- (i) Television broadcast
 - (ii) Microwave link
 - (iii) Satellite communication

CBSE (Delhi) Set-III

Questions uncommon to Set-I and II

6. Current, $I = \frac{E_2 - E_1}{R}$ $[E_2 > E_1]$

$$= \frac{200 - 5}{39}$$

$$= \frac{195}{39} = 5A$$

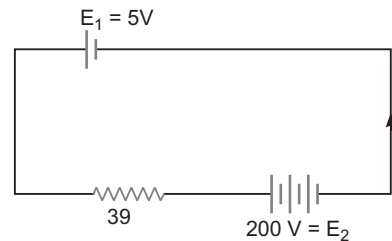

9.

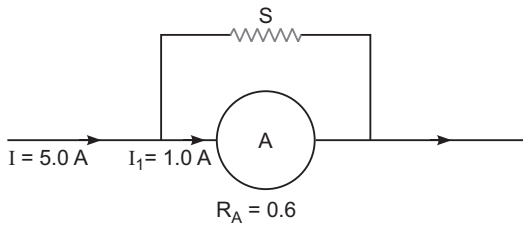

(i) From Ohm's law

$$I_1 R_A = (I - I_1)S$$

$$1.0 \times 0.6 = (5 - 1) \times S$$

$$S = \frac{0.6}{4} = 0.15$$

(ii) Combined resistance $R_{eq} = \frac{R_A S}{R_A + S}$

$$= \frac{0.6 \times 0.15}{0.6 + 0.15} = \frac{0.09}{0.75}$$

$$= \frac{3}{25}$$

$$= 0.12$$

15. Power of convex lens, $P_1 = \frac{1}{f_1 \text{ (in m)}} = \frac{100}{f_1 \text{ (in cm)}}$

$$P_1 = \frac{100}{30} = \frac{10}{3}\text{ D}$$

Power of concave lens, $P_2 = \frac{100}{f_2 \text{ (in cm)}} = \frac{100}{40} = \frac{5}{2}\text{ D}$

Power of the combination, $P = P_1 + P_2$

$$= \frac{10}{3} + \frac{5}{2}$$

$$= \frac{20 + 15}{6} = \frac{35}{6}\text{ D}$$

$$P = \frac{35}{6}\text{ D}$$

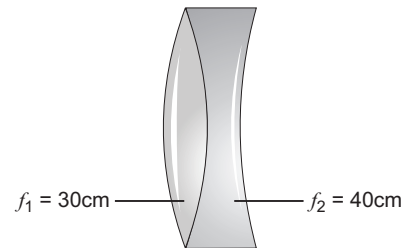

Sign of the power of the combination is positive, so the system behave as a convex converging lens.

19. (a) Distinguish between diffraction and interference

S. No.	Interference	Diffraction
(i)	Intensity of all bright fringes is same.	Intensity of bright fringes decreases on either side of central maxima.
(ii)	Size of all fringes is same.	Size of the central maxima is nearly twice the size of other maxima.

(b) For diffraction at single slit of size 'd'

$$d \sin \theta = d \cdot n = \frac{1}{2} \lambda$$

$$\text{and } \sin \theta = \frac{y}{D}$$

$$d \cdot \frac{y}{D} = n \cdot \frac{1}{2} \lambda$$

$$y = n \cdot \frac{1}{2} \cdot \frac{D}{d} \lambda$$

For wavelengths λ_1 and λ_2 ,
separation between maxima

$$y = n \cdot \frac{1}{2} \cdot \frac{D}{d} [\lambda_2 - \lambda_1]$$

Put $n = 1$, $D = 1.8\text{m}$, $d = 1 \times 10^{-4}\text{m}$, $\lambda_2 = 596\text{ nm}$ and $\lambda_1 = 590\text{ nm}$

$$\begin{aligned} y &= 1 \cdot \frac{1}{2} \cdot \frac{1.8}{1 \cdot 10^{-4}} [596 - 590] \times 10^{-9} \\ &= \frac{3}{2} \cdot \frac{1.8}{1 \cdot 10^{-4}} \cdot 6 \cdot 10^{-9} \\ &= 3 \times 5.4 \times 10^{-5}\text{m} \\ &= 16.2 \times 10^{-5}\text{ m} \\ &= 0.16\text{ mm} \end{aligned}$$

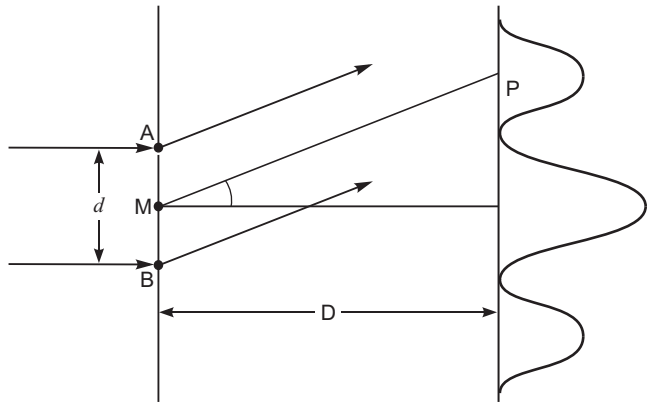

21. In nuclear reaction

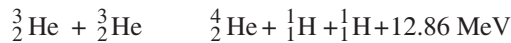

(a) Average binding energy per nucleon BE of ${}^4_2\text{He}$ is more than that of ${}^3_2\text{He}$.

(b) Total mass of the product nuclei becomes less than the total mass of the initial nuclei.

$$m = 2m({}^3_2\text{He}) - m({}^4_2\text{He}) - 2m({}^1_1\text{H})$$

So the energy is released.

$$E = mc^2$$

(b) (i) For separation $r < r_0$, the potential energy is positive.

(ii) For separation $r > r_0$, the potential energy is negative.

25. An electron revolves around the nucleus, in the n th orbit of radius r_n as shown in fig.

$$\frac{1}{4} \cdot \frac{e^2}{r_n^2} = \frac{mv_n^2}{r_n}$$

$$\frac{1}{4} \cdot \frac{e^2}{r_n^2} = mv_n^2 \quad \dots(1)$$

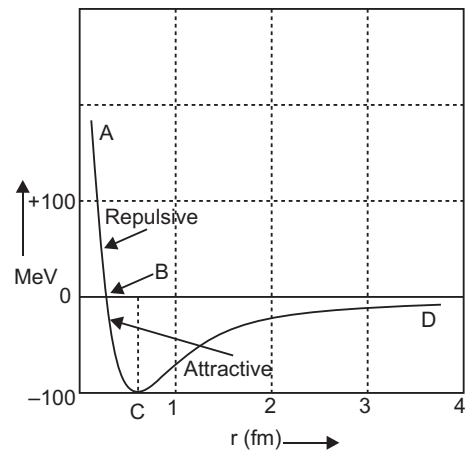

From Bohr's postulate

$$mv_n r_n = \frac{nh}{2} \quad \dots(2)$$

Total energy of the electron in its nth orbit

$$\begin{aligned} E_n &= K + U \\ &= \frac{1}{2}mv_n^2 - \frac{1}{4} \frac{e^2}{r_n} \end{aligned} \quad \dots(3)$$

From equations (1) and (3),

$$\begin{aligned} E_n &= \frac{1}{2}mv_n^2 - mv_n^2 \\ &= -\frac{1}{2}mv_n^2 \end{aligned} \quad \dots(4)$$

On solving equations (1) and (2),

$$v_n = \frac{mv_n^2 r_n}{mv_n r_n} = \frac{\frac{e^2}{4} \frac{1}{r_n}}{\frac{nh}{2}} = \frac{e^2}{2nh}$$

From equation (4),

$$\begin{aligned} \text{Total energy } E_n &= -\frac{1}{2}m \left(\frac{e^2}{2nh} \right)^2 \\ &= -\frac{me^4}{8n^2h^2} \end{aligned}$$

(b) Negative sign shows that electron remain bound with the nucleus.

(c) If electron jumps from $n_i = 4, 5, 6, \dots$ to $n_f = 3$, the energy of the line spectra

$$\begin{aligned} E &= \frac{me^4}{8h^2} \left(\frac{1}{n_f^2} - \frac{1}{n_i^2} \right) \\ &= \frac{me^4}{8h^2} \left(\frac{1}{3^2} - \frac{1}{n_i^2} \right) \end{aligned}$$

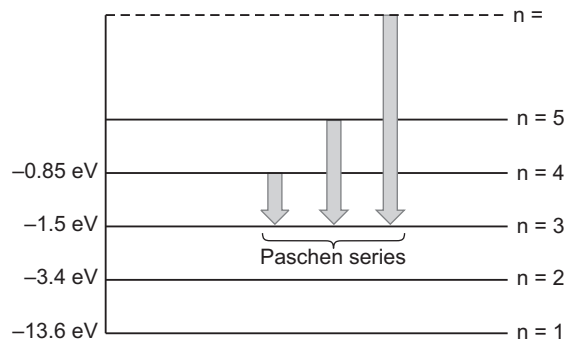

CBSE Examination Papers

All India–2013

SET-I

Time allowed : 3 hours

Maximum marks: 70

General Instructions: As given in CBSE Examination Paper Delhi–2013.

- Two charges of magnitudes $-2Q$ and $+Q$ are located at points $(a, 0)$ and $(4a, 0)$ respectively. What is the electric flux due to these charges through a sphere of radius ' $3a$ ' with its centre at the origin?
- How does the mutual inductance of a pair of coils change when
 - distance between the coils is increased and
 - number of turns in the coils is increased?
- The graph shown in the figure represents a plot of current versus voltage for a given semiconductor. Identify the region, if any, over which the semiconductor has a negative resistance.

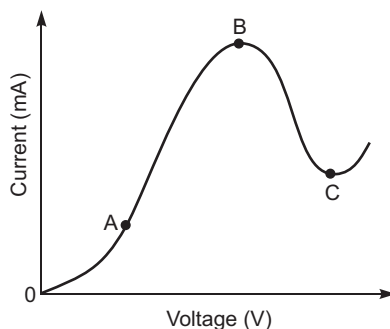

- Two identical cells, each of emf E , having negligible internal resistance, are connected in parallel with each other across an external resistance R . What is the current through this resistance?
- The motion of copper plate is damped when it is allowed to oscillate between the two poles of a magnet. What is the cause of this damping?
- Define the activity of a given radioactive substance. Write its S.I. unit.
- Welders wear special goggles or face masks with glass windows to protect their eyes from electromagnetic radiations. Name the radiations and write the range of their frequency.
- Write the expression for the de Broglie wavelength associated with a charged particle having charge ' q ' and mass ' m ', when it is accelerated by a potential V .
- Draw typical output characteristics of an n-p-n transistor in CE configuration. Show how these characteristics can be used to determine output resistance.

10. A parallel beam of light of 500 nm falls on a narrow slit and the resulting diffraction pattern is observed on a screen 1 m away. It is observed that the first minimum is at a distance of 2.5 mm from the centre of the screen. Calculate the width of the slit.
11. A slab of material of dielectric constant K has the same area as that of the plates of a parallel plate capacitor but has the thickness $d/2$, where d is the separation between the plates. Find out the expression for its capacitance when the slab is inserted between the plates of the capacitor.
12. A capacitor, made of two parallel plates each of plate area A and separation d , is being charged by an external ac source. Show that the displacement current inside the capacitor is the same as the current charging the capacitor.
13. Explain the term 'drift velocity' of electrons in a conductor. Hence obtain the expression for the current through a conductor in terms of 'drift velocity'.

OR

Describe briefly, with the help of a circuit diagram, how a potentiometer is used to determine the internal resistance of a cell.

14. A convex lens of focal length f_1 is kept in contact with a concave lens of focal length f_2 . Find the focal length of the combination.
15. In the block diagram of a simple modulator for obtaining an AM signal, shown in the figure, identify the boxes A and B. Write their functions.

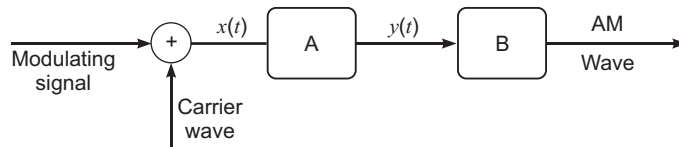

16. In the circuit shown in the figure, identify the equivalent gate of the circuit and make its truth table.

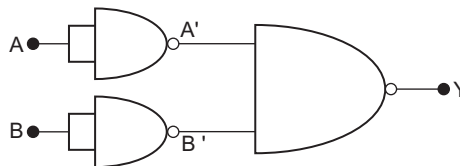

17. (a) For a given a.c., $i = i_m \sin t$, show that the average power dissipated in a resistor R over a complete cycle is $\frac{1}{2} i_m^2 R$.
- (b) A light bulb is rated at 100 W for a 220 V a.c. supply. Calculate the resistance of the bulb.
18. A rectangular conductor LMNO is placed in a uniform magnetic field of 0.5 T. The field is directed perpendicular to the plane of the conductor. When the arm MN of length of 20 cm is moved towards left with a velocity of 10 ms^{-1} , calculate the emf induced in the arm. Given the resistance of the arm to be 5 Ω (assuming that other arms are of negligible resistance) find the value of the current in the arm.

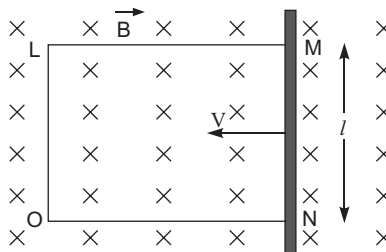

OR

A wheel with 8 metallic spokes each 50 cm long is rotated with a speed of 120 rev/min in a plane normal to the horizontal component of the Earth's magnetic field. The Earth's magnetic field at the plane is 0.4 G and the angle of dip is 60° . Calculate the emf induced between the axle and the rim of the wheel. How will the value of emf be affected if the number of spokes were increased?

19. Define the current sensitivity of a galvanometer. Write its S.I. unit.

Figure shows two circuits each having a galvanometer and a battery of 3 V.

When the galvanometers in each arrangement do not show any deflection, obtain the ratio R_1 / R_2 .

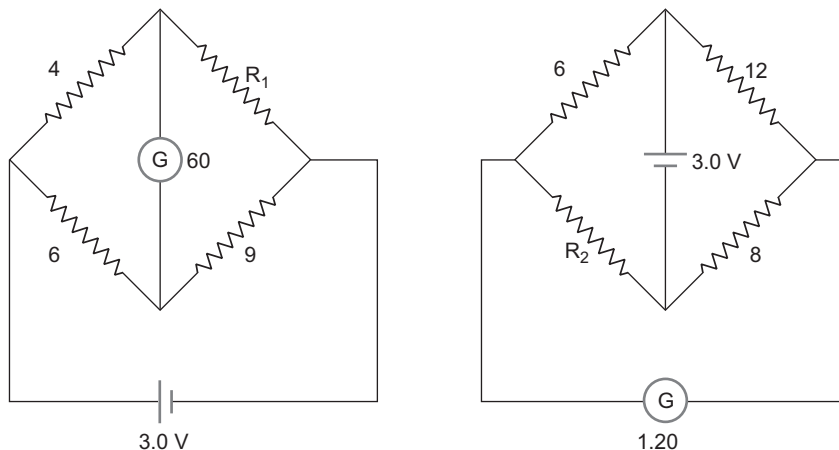

20. A wire AB is carrying a steady current of 12 A and is lying on the table. Another wire CD carrying 5 A is held directly above AB at a height of 1 mm. Find the mass per unit length of the wire CD so that it remains suspended at its position when left free. Give the direction of the current flowing in CD with respect to that in AB. [Take the value of $g = 10 \text{ ms}^{-2}$]
21. Draw $V - I$ characteristics of a p-n junction diode. Answer the following questions, giving reasons:
- Why is the current under reverse bias almost independent of the applied potential upto a critical voltage?
 - Why does the reverse current show a sudden increase at the critical voltage?

Name any semiconductor device which operates under the reverse bias in the breakdown region.

22. Draw a labelled ray diagram of a refracting telescope. Define its magnifying power and write the expression for it.
Write two important limitations of a refracting telescope over a reflecting type telescope.
23. Write Einstein's photoelectric equation and point out any two characteristic properties of photons on which this equation is based.
Briefly explain the three observed features which can be explained by this equation.
24. Name the type of waves which are used for line of sight (LOS) communication. What is the range of their frequencies?

A transmitting antenna at the top of a tower has a height of 20 m and the height of the receiving antenna is 45 m. Calculate the maximum distance between them for satisfactory communication in LOS mode. (Radius of the Earth = $6.4 \times 10^6 \text{ m}$)

25. (a) What is linearly polarized light? Describe briefly using a diagram how sunlight is polarised.
 (b) Unpolarised light is incident on a polaroid. How would the intensity of transmitted light change when the polaroid is rotated?
26. One day Chetan's mother developed a severe stomach ache all of a sudden. She was rushed to the doctor who suggested for an immediate endoscopy test and gave an estimate of expenditure for the same. Chetan immediately contacted his class teacher and shared the information with her. The class teacher arranged for the money and rushed to the hospital. On realising that Chetan belonged to a below average income group family, even the doctor offered concession for the test fee. The test was conducted successfully.

Answer the following questions based on the above information:

- (a) Which principle in optics is made use of in endoscopy?
 (b) Briefly explain the values reflected in the action taken by the teacher.
 (c) In what way do you appreciate the response of the doctor on the given situation?
27. (a) Using Biot-Savart's law, derive the expression for the magnetic field in the vector form at a point on the axis of a circular current loop.
 (b) What does a toroid consist of? Find out the expression for the magnetic field inside a toroid for N turns of the coil having the average radius r and carrying a current I . Show that the magnetic field in the open space inside and exterior to the toroid is zero.

OR

- (a) Draw a schematic sketch of a cyclotron. Explain clearly the role of crossed electric and magnetic field in accelerating the charge. Hence derive the expression for the kinetic energy acquired by the particles.
 (b) An α -particle and a proton are released from the centre of the cyclotron and made to accelerate.
 (i) Can both be accelerated at the same cyclotron frequency? Give reason to justify your answer.
 (ii) When they are accelerated in turn, which of the two will have higher velocity at the exit slit of the dees?
28. (a) Define electric dipole moment. Is it a scalar or a vector? Derive the expression for the electric field of a dipole at a point on the equatorial plane of the dipole.
 (b) Draw the equipotential surfaces due to an electric dipole. Locate the points where the potential due to the dipole is zero.

OR

Using Gauss' law deduce the expression for the electric field due to a uniformly charged spherical conducting shell of radius R at a point (i) outside and (ii) inside the shell.

Plot a graph showing variation of electric field as a function of $r > R$ and $r < R$. (r being the distance from the centre of the shell)

29. Using Bohr's postulates, derive the expression for the frequency of radiation emitted when electron in hydrogen atom undergoes transition from higher energy state (quantum number n_i) to the lower state, (n_f).
- When electron in hydrogen atom jumps from energy state $n_i = 4$ to $n_f = 3, 2, 1$, identify the spectral series to which the emission lines belong.

OR

- Draw the plot of binding energy per nucleon (BE/A) as a function of mass number A . Write two important conclusions that can be drawn regarding the nature of nuclear force.
- Use this graph to explain the release of energy in both the processes of nuclear fusion and fission.
- Write the basic nuclear process of neutron undergoing β^- -decay. Why is the detection of neutrinos found very difficult?

SET-II

Questions Uncommon to Set-I

- Two charges of magnitudes $-3Q$ and $+2Q$ are located at points $(a, 0)$ and $(4a, 0)$ respectively. What is the electric flux due to these charges through a sphere of radius ' $5a$ ' with its centre at the origin?
- A light metal disc on the top of an electromagnet is thrown up as the current is switched on. Why? Give reason.
- In the circuit shown in the figure, identify the equivalent gate of the circuit and make its truth table.

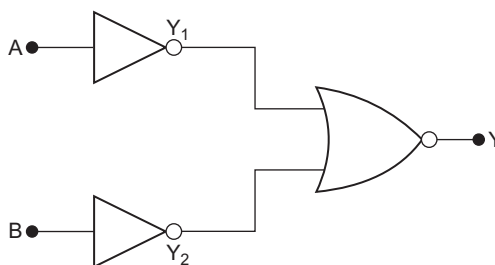

- A parallel beam of light of 600 nm falls on a narrow slit and the resulting diffraction pattern is observed on a screen 1.2 m away. It is observed that the first minimum is at a distance of 3 mm from the centre of the screen. Calculate the width of the slit.
- A wire AB is carrying a steady current of 10 A and is lying on the table. Another wire CD carrying 6 A is held directly above AB at a height of 2 mm . Find the mass per unit length of the wire CD so that it remains suspended at its position when left free. Give the direction of the current flowing in CD with respect to that in AB . [Take the value of $g = 10 \text{ ms}^{-2}$]
- Name the type of waves which are used for line of sight (LOS) communication. What is the range of their frequencies?

A transmitting antenna at the top of a tower has a height of 45 m and the height of the receiving antenna is 80 m . Calculate the maximum distance between them for satisfactory communication in LOS mode. (Radius of the Earth $6.4 \times 10^6 \text{ m}$).

SET-III

Questions Uncommon to Set-I and II

- Two charges of magnitudes $+4Q$ and $-Q$ are located at points $(a, 0)$ and $(-3a, 0)$ respectively. What is the electric flux due to these charges through a sphere of radius ' $2a$ ' with its centre at the origin?
- The motion of copper plate is damped when it is allowed to oscillate between the two poles of a magnet. If slots are cut in the plate, how will the damping be affected?

6. How does the mutual inductance of a pair of coils change when
- distance between the coils is decreased and
 - number of turns in the coils is decreased?
9. In the circuit shown in the figure, identify the equivalent gate of the circuit and make its truth table.

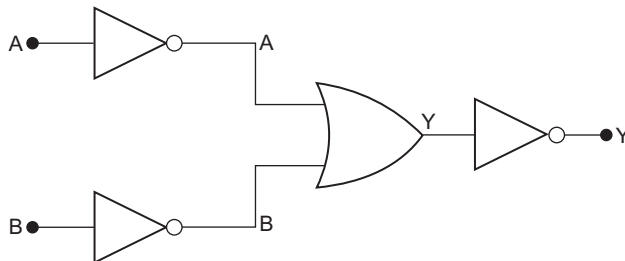

15. A slab of material of dielectric constant K has the same area as that of the plates of a parallel plate capacitor but has the thickness $2d/3$, where d is the separation between the plates. Find out the expression for its capacitance when the slab is inserted between the plates of the capacitor.
25. Name the type of waves which are used for line of sight (LOS) communication. What is the range of their frequencies?

A transmitting antenna at the top of a tower has a height of 45 m and the receiving antenna is on the ground. Calculate the maximum distance between them for satisfactory communication in LOS mode. (Radius of the Earth 6.4×10^6 m).



Solutions

SET-I

1. Electric flux, $\frac{-2Q}{0}$

Concept: (i) Mark the position of the charges on number line.

(ii) Draw a sphere of radius $3a$ about the origin and observe that which charge is inside the sphere, and then use Gauss theorem.

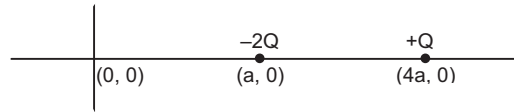

2. (i) Mutual inductance decreases.
(ii) Mutual inductance increases.

Concept: (i) If distance between two coils is increased as shown in figure,

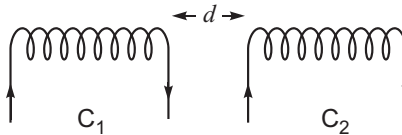

It causes decrease in magnetic flux linked with the coil C_2 . Hence induced emf in coil C_2 decreases by relation $\frac{-d\phi}{dt}$. Hence mutual inductance decreases.

(ii) From relation $M_{21} = \mu_0 n_1 n_2 Al$, if number of turns in one of the coils or both increases, means mutual inductance will increase.

3. In region BC *i.e.*, the region showing negative slope.

Concept: In figure draw two horizontal lines, as marked by dotted lines and use the formula:

$$R = \frac{V}{I} \text{ in the region, B to C.}$$

4. Current, $I = \frac{E}{R}$

Concept: (i) emf of combination of two (or more cells) remain same.

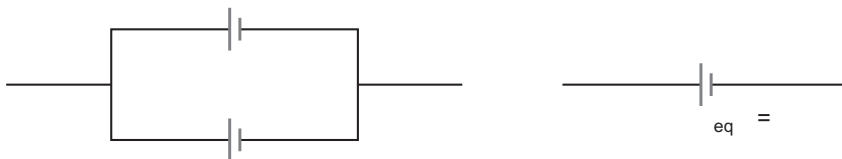

(ii) Internal resistance is negligible *i.e.*, zero.

$$\text{So, } I = \frac{eq}{R + r_{eq}} \approx \frac{eq}{R} \quad (r_{eq} = 0)$$

5. As the plate oscillate, the changing magnetic flux through the plate produces a strong eddy current in the direction, which opposes the cause.

Also, copper being diamagnetic substance, it gets magnetised in the opposite direction, so the plate motion gets damped.

6. The rate of decay of a radioactive substance is called activity of that substance.

It is negative of the rate of decay of the radioactive substance.

$$\text{Activity, } R = \frac{N - N'}{t - t'}$$

$$= - \frac{dN}{dt}$$

$$\lim_{t \rightarrow 0} - \frac{dN}{dt}$$

S.I. unit of activity (i) becquerel (Bq).

(ii) decay per second.

7. Ultraviolet radiations

OR

Radiations above violet (in VIBGYOR)

Frequency range $10^{15} - 10^{17}$ Hz.

Hint: Frequency of visible light is of the order of 10^{14} Hz.

8. de Broglie wavelength $\lambda = \frac{h}{p} = \frac{h}{\sqrt{2mqV}}$

Hint: $W = K = qV = \frac{p^2}{2m}$ or $p = \sqrt{2mqV}$

- 9.

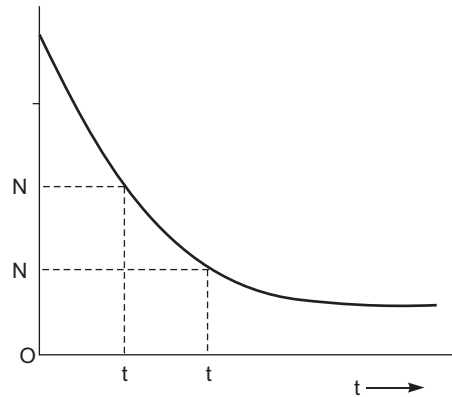
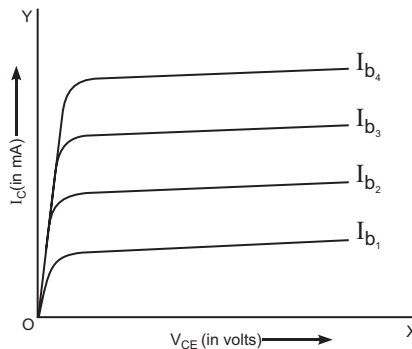

The reciprocal of the slope of the linear part of the output characteristics represents the output resistance.

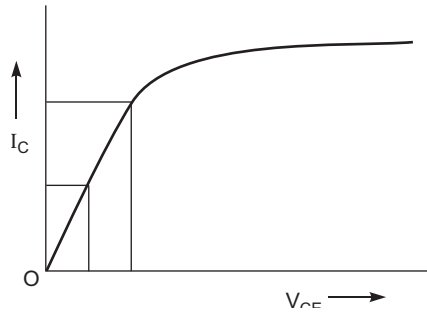

$$r_0 = \frac{V_{CE}}{I_C} \quad (\text{as shown in fig.})$$

10.

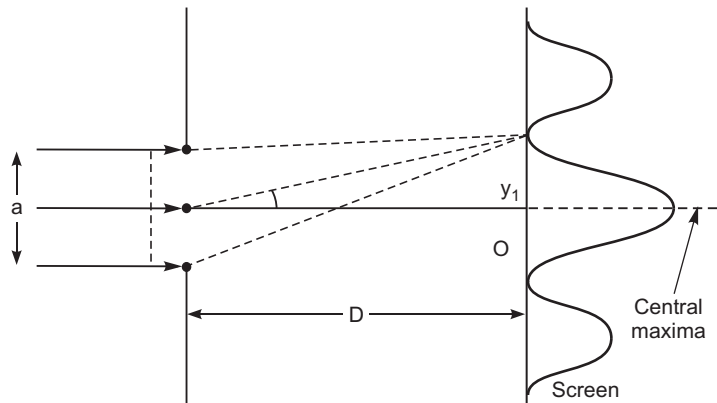

Hint: From condition of diffraction,

$$a \sin \theta = n \lambda \quad (\text{for minima})$$

$$a \sin \theta = \frac{n \lambda}{2} \quad \text{for maxima}$$

Provided $n = 1, 2, 3, \dots$

and $n = 0$ for central maxima

From condition of minima,

$$a \sin \theta = n \lambda$$

Since the value of λ is of nm, so

$a =$

$$a \cdot \frac{y}{D}$$

$$a = \frac{D}{y}$$

$$a = \frac{500 \times 10^{-9}}{2.5 \times 10^{-3}} \text{ m}$$

$$= 2 \times 10^{-4} \text{ m}$$

$$\text{angle} = \frac{\text{arc}}{\text{radius}}$$

11.

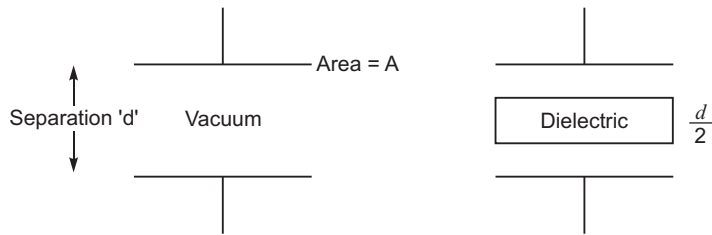

Capacitance with dielectric of thickness 't'

$$C = \frac{\epsilon_0 A}{d - t} \frac{t}{K}$$

Put $t = \frac{d}{2}$

$$C = \frac{\epsilon_0 A}{d - \frac{d}{2}} \frac{\frac{d}{2}}{K}$$

$$\frac{\epsilon_0 A}{\frac{d}{2}} \frac{\frac{d}{2}}{2K}$$

$$\frac{\epsilon_0 A}{\frac{d}{2}} \frac{1}{K}$$

$$\frac{2 \epsilon_0 AK}{d(K - 1)}$$

12.

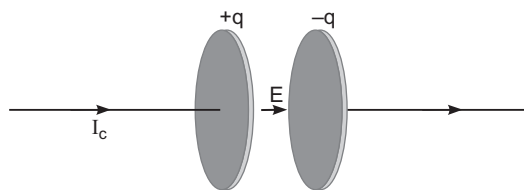

In Fig. conduction current is flowing in the wires, causes charge on the plates

So $I_c = \frac{dq}{dt}$ (1)

According to Maxwell, displacement current between plates

$$I_d = \epsilon_0 \frac{dE}{dt}, \text{ where } E = \text{Electric flux} \quad (2)$$

Using Gauss's Theorem, if one of the plate is inside the tiffin type Gaussian surface

$$E = \frac{q}{\epsilon_0}$$

$$\text{So } I_d = \frac{dq}{dt}$$

$$I_d = \frac{dq}{dt} \quad (3)$$

From equation (2) and (3),

Both conduction current and displacement currents are equal.

13. The modified velocity gained by the accelerating electrons in uniform electric field inside the conductor is called drift velocity.

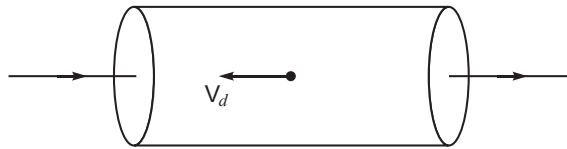

The average velocity, acquired by free electrons along the length of a metallic conductor, due to existing electric field is called drift velocity.

Let n be the number density of free electrons in a conductor of length l and area of cross-section 'A'.

Total charge in the conductor, $Q = Ne$

$$(nAl)e$$

Time taken at average velocity v_d is $t = \frac{l}{v_d}$

So, by definition, $I = \frac{Q}{t} = \frac{(nAl)e}{\frac{l}{v_d}}$

$$I = neAv_d$$

OR

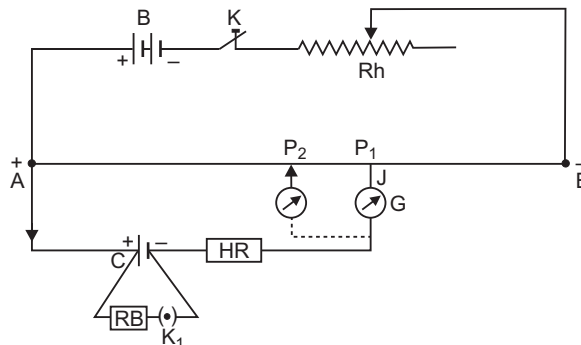

If key k_1 is closed, (while key k_2 is open), galvanometer shows null deflection at balancing length l_1 .

So, $E = k l_1$ (1)

If both keys k_1 and k_2 are closed and R is the resistance of resistance box, galvanometer now shows null deflection at balancing length l_2 ($l_2 < l_1$).

So, $V = k l_2$ (2)

From relation, $r = R \frac{E}{V} - 1$

We have, $r = R \frac{l_1}{l_2} - 1$

14.

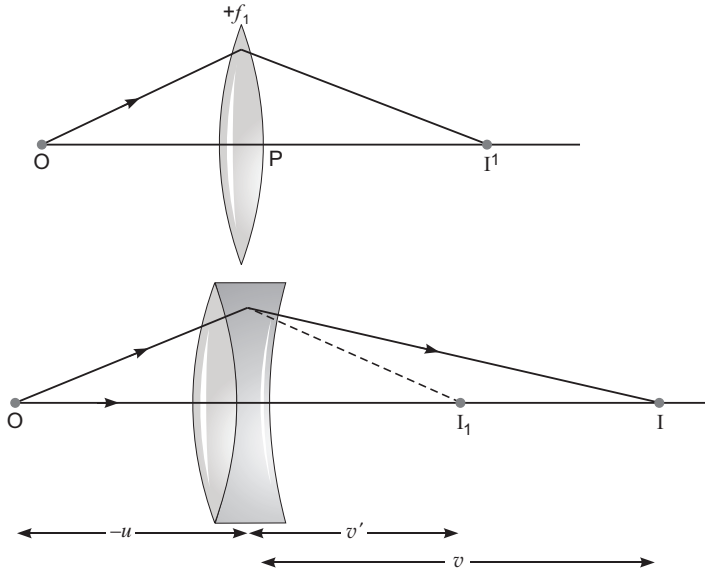

For convex lens of focal length (+ f_1)

$$\frac{1}{f_1} - \frac{1}{v} = -\frac{1}{u} \quad (1)$$

For concave lens of focal length ($-f_2$)

$$-\frac{1}{f_2} - \frac{1}{v} = -\frac{1}{v'} \quad (2)$$

Adding equation (1) and (2)

$$\frac{1}{f_1} - \frac{1}{f_2} - \frac{1}{v} = -\frac{1}{u} \quad (3)$$

For an equivalent lens (using lens formula)

$$\frac{1}{f} - \frac{1}{v} = -\frac{1}{u}, \text{ where } f \text{ is the focal length of combination.} \quad (4)$$

From equation (3) and (4),

$$\frac{1}{f} - \frac{1}{f_1} = -\frac{1}{f_2}$$

15. Boxes 'A' and 'B' represents

(i) square law device

(ii) band pass filter

(i) Square law device is a non linear device and produces the output

$$y(t) = Bx(t) + Cx(t)^2$$

where B and C are constants.

(ii) It rejects dc and sinusoids of frequencies $\omega_m, 2\omega_m$ and $2\omega_c$ and finally produces amplitude modulated wave by retaining frequencies $\omega_c, \omega_c - \omega_m$ and $\omega_c + \omega_m$.

16.

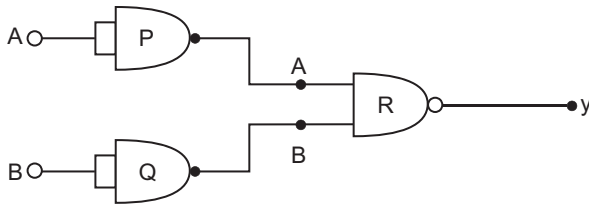

Gates, P, Q and R act as NOT, NOT and NAND gates respectively.

So $y = \overline{\overline{A} \cdot \overline{B}} = A + B$

The combination acts as OR Gate.

Truth Table of the combination

A	B	\overline{A}	\overline{B}	$\overline{A \cdot B}$	$\overline{\overline{A \cdot B}}$	Y
0	0	1	1	1	0	0
1	0	0	1	0	1	1
0	1	1	0	0	1	1
1	1	0	0	0	1	1

Truth Table of OR Gate

A	B	Y
0	0	0
1	0	1
0	1	1
1	1	1

17. (a) From graph of $i^2 - t$

Average power consumed in resistor R

$$P_{av} = \frac{1}{T} \int_0^T i^2 R dt$$

$$= \frac{i_m^2 R}{T} \int_0^T \sin^2 \omega t dt \quad \dots(1)$$

$$= \frac{i_m^2 R}{2T} \int_0^T (1 - \cos 2\omega t) dt$$

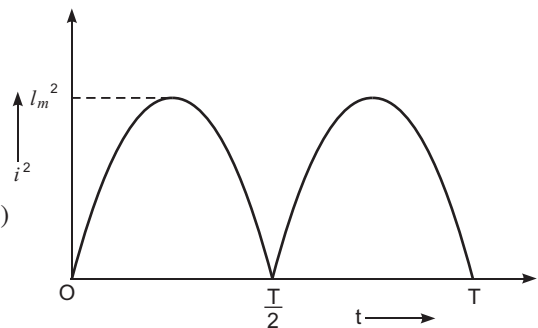

$$\frac{i_m^2 R}{2T} \int_0^T dt - \int_0^T \cos 2t dt \tag{2}$$

$$\frac{i_m^2 R}{2T} [T - 0]$$

$$\frac{i_m^2 R}{2}$$

(b) In case of ac

$$P_{av} = \frac{V_{rms}^2}{R} = \frac{V_{eff}^2}{R}$$

$$R = \frac{V_{rms}^2}{P_{av}}$$

$$\frac{220^2}{100}$$

$$484$$

18. Induced emf in a moving rod in a magnetic field is given by

$$-Blv$$

Since the rod is moving to the left so

$$Blv$$

$$0.5 \times 0.2 \times 10$$

$$1$$

Current in the rod $I = \frac{1}{R} = \frac{1}{5} = 0.2A$

OR

If a rod of length 'l' rotates with angular speed ω in uniform magnetic field 'B'

$$\frac{1}{2} Bl^2 \omega$$

In case of earth's magnetic field $B_H = |B_e| \cos \theta$

and $B_V = |B_e| \sin \theta$

$$\frac{1}{2} |B_e| \cos \theta \cdot l^2 \omega$$

$$\frac{1}{2} \times 0.4 \times 10^{-4} \times \cos 60^\circ \times (0.5)^2 \times 2$$

$$\frac{1}{2} \times 0.4 \times 10^{-4} \times \frac{1}{2} \times (0.5)^2 \times 2 \times \frac{120 \text{ rev}}{60 \text{ s}}$$

$$10^{-5} \times 0.25 \times 2 \times 3.14 \times 2$$

$$3.14 \times 10^{-5} \text{ volt}$$

Induced emf is independent of the number of spokes *i.e.*, it remain same.

19. Ratio of deflection produced in the galvanometer to the current flowing through it.

Current sensitivity $S_i = \frac{\theta}{I}$

S.I. unit of current sensitivity S_i is division/ampere or radian/ampere.

For balanced Wheatstone bridge, if no current flows through the galvanometer

$$\frac{4}{R_1} \frac{6}{9} = R_1 \frac{4}{6} \frac{9}{6}$$

For another current

$$\frac{6}{12} \frac{R_2}{8} = R_2 \frac{6}{12} \frac{8}{4}$$

$$\frac{R_1}{R_2} = \frac{6}{4} \frac{3}{2}$$

20. Concepts: (i) Current carrying conductors repel each other, if current flows in the opposite direction.

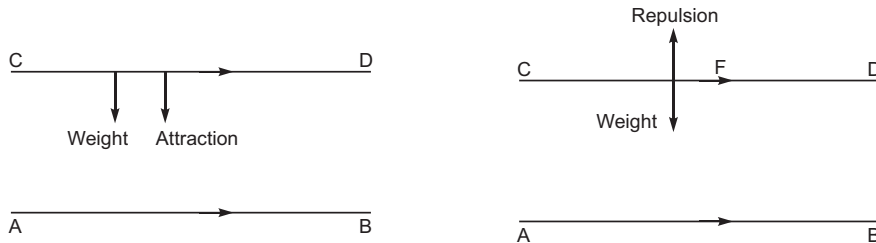

(ii) Attract each other if current flows in the same direction.

If wire CD remain suspended above AB then

$$\frac{F_{repulsion}}{2} = \frac{\text{Weight}}{r} = mg$$

where r = Separation between the wires

$$\frac{m}{l} = \frac{\mu_0 I_1 I_2}{2 r g}$$

$$\frac{2 \times 10^{-7} \times 12 \times 5}{1 \times 10^{-3} \times 10}$$

$$1.2 \times 10^{-3} \text{ kg/m}$$

Current in CD should be in opposite direction to that in AB.

21.

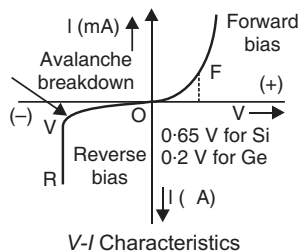

- (i) In the reverse biasing, the current of order of μA is due to movement/drift of minority charge carriers from one region to another through the junction.

A small applied voltage is sufficient to sweep the minority charge carriers through the junction. So reverse current is almost independent of critical voltage.

- (ii) At critical voltage (or breakdown voltage), a large number of covalent bonds break, resulting in the increase of large number of charge carriers. Hence current increases at critical voltage. Semiconductor device that is used in reverse biasing is zener diode.

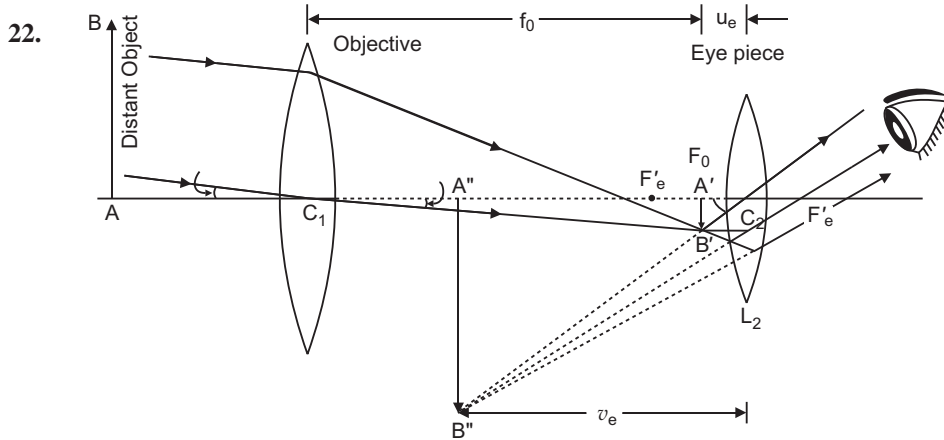

It is defined as the ratio of the angle () subtended by the final image on the eye to the angle () subtended by the object on eye.

$$M = \frac{\tan \beta}{\tan \alpha}$$

Magnifying power $M = \frac{-f_0}{f_e}$ (for comfortable view)

$\frac{-f_0}{f_e} + 1 = \frac{f_e}{D}$ (for strained eye)

Limitations: (i) Image is not free from chromatic aberration and spherical aberration.

(ii) Aperture of the objective lens should be large for high resolving power.

23. If radiation of frequency () greater than threshold frequency () irradiate the metal surface, electrons emitted out from the metal. So Einstein's photoelectric equation can be given as

$$K_{\max} = \frac{1}{2}mv_{\max}^2 = h\nu - h\nu_0$$

Characteristic properties of photons:

- (i) Energy of photon is directly proportional to the frequency (or inversely proportional to the wavelength).
- (ii) In photon-electron collision, total energy and momentum of the system of two constituents remains constant.
- (iii) In the interaction of photons with the free electrons, the entire energy of photon is absorbed.

Features of photoelectric effects

- (i) **Explanation of frequency law:** When frequency of incident photon (), increases, the kinetic energy of emitted electron increases. Intensity has no effect on kinetic energy of photoelectrons.

- (ii) **Explanation of intensity law:** When intensity of incident light increases, the number of incident photons increases, as one photon ejects one electron; the increase in intensity will increase the number of ejected electrons. In other words, photocurrent will increase with increase of intensity. Frequency has no effect on photocurrent.
- (iii) **Explanation of no time lag law:** When the energy of incident photon is greater than work function, the photoelectron is immediately ejected. Thus, there is no time lag between incidence of light and emission of photoelectrons.

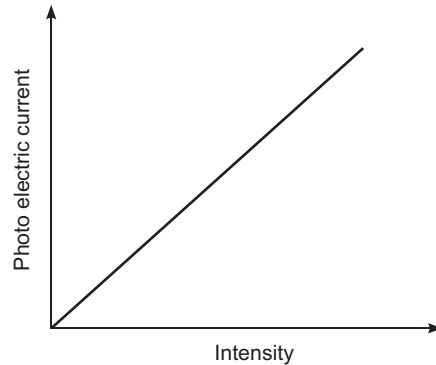

24. Name of the wave may be (i) space wave (ii) radiowave (iii) microwave.
Frequency for LOS communication must be more than 40 MHz.
Maximum distance between transmitting antenna and receiving antenna is

$$d_{\max} = \sqrt{2Rh_T} + \sqrt{2Rh_R}$$

$$= \sqrt{2 \times 6.4 \times 10^6 \times 20} + \sqrt{2 \times 6.4 \times 10^6 \times 45}$$

$$= (16 + 24) \times 10^3 \text{ m}$$

$$= 40 \text{ km}$$

25. (a) Molecules in air behave like a dipole radiator. When the sunlight falls on a molecule, dipole molecule does not scatter energy along the dipole axis, however the electric field vector of light wave vibrates just in one direction perpendicular to the direction of the propagation. The light wave having direction of electric field vector in a plane is said to be linearly polarised. In figure, a dipole molecule is lying along x-axis. Molecules behave like dipole radiators and scatter no energy along the dipole axis.

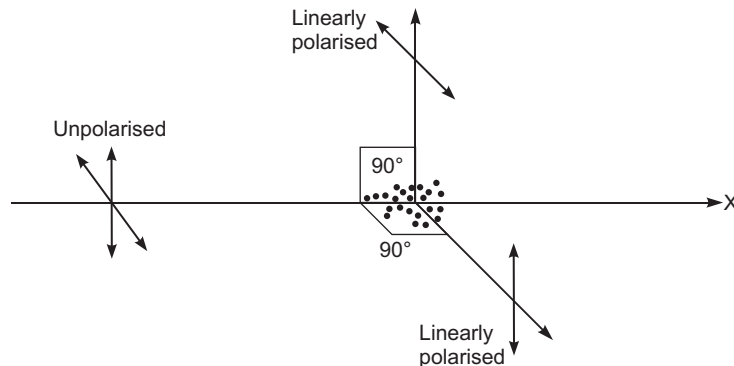

The unpolarised light travelling along x-axis strikes on the dipole molecule get scattered along y and z directions. Light traversing along y and z directions is plane polarised light.

- (b) In figure unpolarised light falls on the polaroid, and transmitted light has electric vibrations in the plane consisting of polaroid axis and direction of wave propagation as shown in Fig.

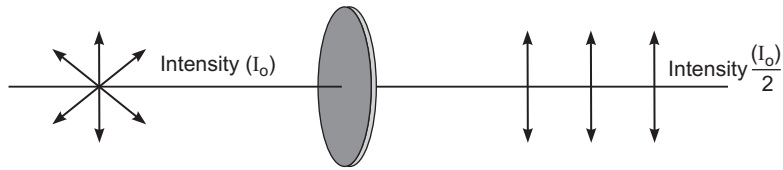

If polaroid is rotated the plane of polarisation will change, however the intensity of transmitted light remain unchanged.

26. (a) **Total internal reflection:** If a light ray enters at one end of an optic fibre coated with a material of low refractive index, it refracted and strikes the walls at angle greater than critical angle. Thus light rays shows multiple reflections, without being absorbed at the side walls.

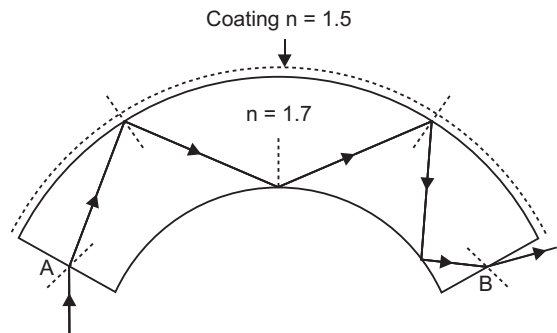

- (b) The teacher knows that Chetan belongs to a below average income group family, so he/she immediately arranged the money required to be paid as test fee. His/her caring and helping attitude towards the others resulted in timely help to Chetan's mother.

Such helping attitude on the part of the person living in the society make it a better society to live in.

- (c) Seeing the situation of Chetan's family and helping attitude of class teacher, doctor took the sympathetic view of the situation, and give the reduction in fee, which is highly appreciable. Such professional ethics of doctor in the society would be an immense help to the person's belonging to below average income groups.

27. (a) **Magnetic field at the axis of a circular loop:** Consider a circular loop of radius R carrying current I , with its plane perpendicular to the plane of paper. Let P be a point of observation on the axis of this circular loop at a distance x from its centre O . Consider a small element of length dl of the coil at point A . The magnitude of the magnetic induction dB at point P due to this element is given by

$$dB = \frac{\mu_0 I dl \sin \theta}{4 r^2}$$

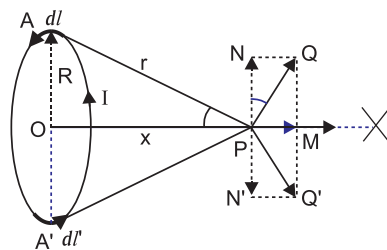

...(i)

The direction of dB is perpendicular to the plane containing dl and r and is given by right hand screw rule. As the angle between $I dl$ and r is 90° , the magnitude of the magnetic induction dB is given by,

$$dB = \frac{0 I dl \sin 90}{4 r^2} = \frac{0 I dl}{4 r^2} \quad \dots(ii)$$

If we consider the magnetic induction produced by the whole of the circular coil, then by symmetry the components of magnetic induction perpendicular to the axis will be cancelled out, while those parallel to the axis will be added up. Thus the resultant magnetic induction B at axial point P is along the axis and may be evaluated as follows:

The component of dB along the axis,

$$dB_x = \frac{0 I dl}{4 r^2} \sin \theta \quad \dots(iii)$$

But $\sin \theta = \frac{R}{r}$ and $r = (R^2 + x^2)^{1/2}$

$$dB_x = \frac{0 I dl}{4 r^2} \frac{R}{r} = \frac{0 IR dl}{4 (R^2 + x^2)^{3/2}} \quad \dots(iv)$$

Therefore the magnitude of resultant magnetic induction at axial point P due to the whole circular coil is given by

$$B = \oint \frac{0 IR}{4 (R^2 + x^2)^{3/2}} dl = \frac{0 IR}{4 (R^2 + x^2)^{3/2}} \oint dl$$

But $\oint dl$ length of the loop $= 2\pi R$... (v)

Therefore, $B = \frac{0 IR}{4 (R^2 + x^2)^{3/2}} (2\pi R)$

$$B = B_x \hat{i} = \frac{0 IR^2}{2 (R^2 + x^2)^{3/2}} \hat{i}$$

(b) A long solenoid on bending in the form of closed ring is called a toroidal solenoid.

Figure shows a toroidal solenoid of average radius 'r' and of N turns.

(i) For points inside the core of toroid

Current I , flowing through it, set up a magnetic field within the core.

According to Ampere's circuital law

$$\oint B \cdot dl = \mu_0 I$$

where ' I ' is the current in the toroid.

Net current $= NI$

$$\oint B \cdot dl = \mu_0 NI$$

$$|B| \int dl = \mu_0 NI$$

$$|B| = \frac{\mu_0 NI}{2\pi r}$$

$$\therefore n = \frac{N}{2\pi r}$$

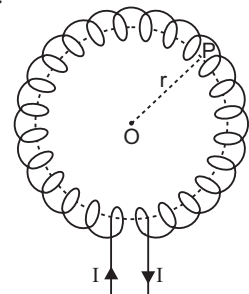

(ii) For points in the open space *inside the toroid*: No current flows through the Amperian loop, so $I = 0$

$$\oint B \cdot dl = \mu_0 I = 0$$

$$|B|_{\text{inside}} = 0$$

(iii) For points in the open space *exterior to the toroid*: The net current entering the plane of the toroid is exactly cancelled by the net current leaving the plane of the toroid.

$$\oint B \cdot dl = 0$$

$$|B|_{\text{exterior}} = 0$$

OR

Role of electric field (i) Electric field accelerates the charge particle passing through the gap with the help of electric oscillator.

(ii) Electric oscillator imparts the energy to charged particle till it comes out from the exit slit.

Role of magnetic field

As the accelerated charge particle enters normally to the uniform magnetic field, it exerts a magnetic force in the form of centripetal force and charge particle moves on a semicircular path of increasing radii in each dee (D_1 or D_2).

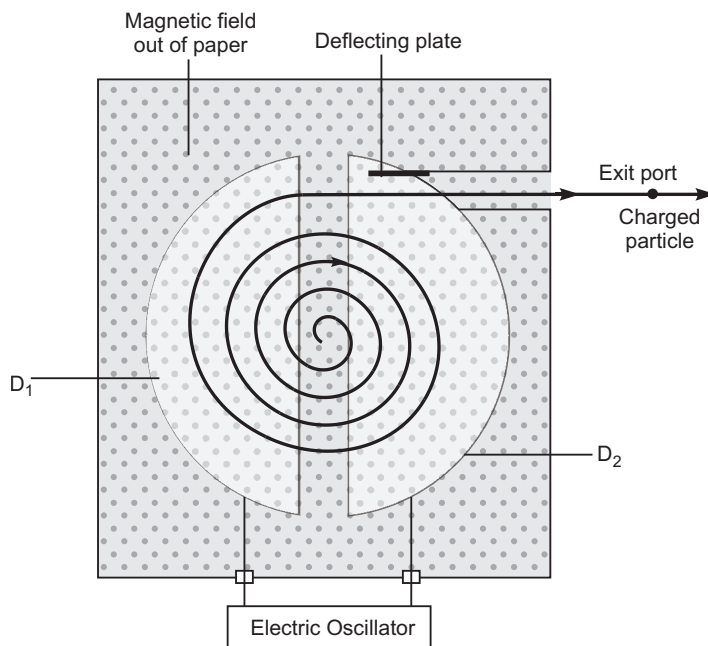

$$\text{So } qvB = \frac{mv^2}{r}$$

$$v = \frac{qBr}{m} \quad (1)$$

$$\text{Kinetic energy } K = \frac{1}{2}mv^2$$

$$= \frac{q^2 B^2 r^2}{2m} \quad (2)$$

(b) (i) No, from equation (1) $v = \frac{qBr}{m}$

$$v = r \frac{qBr}{m}$$

$$2 \frac{qB}{m}$$

$$\frac{qB}{2m}$$

Cyclotron frequency depends on $\frac{q}{m}$ ratio, since

$$\frac{q}{m} \quad \frac{q}{m} \quad p$$

or p

(ii) From equation (2), kinetic energy $K = \frac{q^2 B^2 r^2}{2m}$

$$\frac{q^2}{m} \quad \frac{q^2}{m} \quad \text{proton}$$

So, proton acquires higher velocity at the exit slit for fixed radius $r = R$, where R is the radius of the dee.

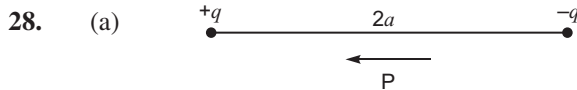

It is defined as the product of either charge and the distance between the two equal and opposite charges

$$|P| = q \cdot 2a$$

It is a vector quantity, so $P = q \cdot 2a$

Derivation

At a point of equatorial plane : Consider a point P on broad side on the position of dipole formed of charges $+q$ and $-q$ at separation $2l$. The distance of point P from mid point (O) of electric dipole is r . Let E_1 and E_2 be the electric field strengths due to charges $+q$ and $-q$ of electric dipole.

From fig. $AP = BP = \sqrt{r^2 + l^2}$

$$E_1 = \frac{1}{4\pi\epsilon_0} \frac{q}{r^2 + l^2} \text{ along } B \text{ to } P$$

$$E_2 = \frac{1}{4\pi\epsilon_0} \frac{q}{r^2 + l^2} \text{ along } P \text{ to } A$$

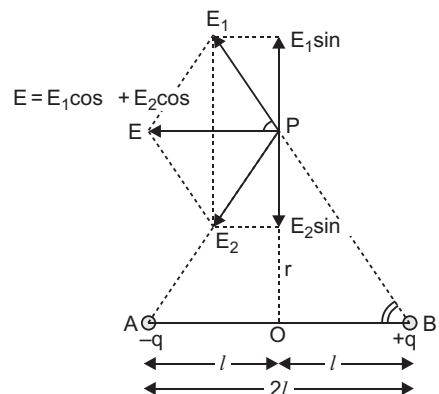

Clearly E_1 and E_2 are equal in magnitude *i.e.* $|E_1| = |E_2|$ or $E_1 = E_2$

To find the resultant of E_1 and E_2 , we resolve them along and perpendicular to AB .

Component of E_1 along AB $E_1 \cos \theta$, parallel to **BA**

Component of E_1 perpendicular to AB $E_1 \sin \theta$ along O to P

Component of E_2 along AB $E_2 \cos \theta$, parallel to **BA**

Component of E_2 perpendicular to AB $E_2 \sin \theta$ along P to O

Clearly components of E_1 and E_2 perpendicular to AB : $E_1 \sin \theta$ and $E_2 \sin \theta$ being equal and opposite cancel each other, while the components of E_1 and E_2 along AB : $E_1 \cos \theta$ and $E_2 \cos \theta$, being in the same direction add up and give the resultant electric field whose direction is parallel to **BA**.

Resultant electric field at P is $E = E_1 \cos \theta + E_2 \cos \theta$

$$\text{But } E_1 = E_2 = \frac{1}{4\pi\epsilon_0} \frac{q}{(r^2 + l^2)}$$

$$\text{and } \cos \theta = \frac{OB}{PB} = \frac{l}{\sqrt{r^2 + l^2}} = \frac{l}{(r^2 + l^2)^{1/2}}$$

$$E = 2E_1 \cos \theta = 2 \frac{1}{4\pi\epsilon_0} \frac{q}{(r^2 + l^2)} \frac{l}{(r^2 + l^2)^{1/2}}$$

$$= \frac{1}{4\pi\epsilon_0} \frac{2ql}{(r^2 + l^2)^{3/2}}$$

But $q \cdot 2l = p$ electric dipole moment

$$E = \frac{1}{4\pi\epsilon_0} \frac{p}{(r^2 + l^2)^{3/2}} \quad \dots(iii)$$

If dipole is infinitesimal and point P is far away, we have $l \ll r$, so l^2 may be neglected as compared to r^2 and so equation (3) gives

$$E = \frac{1}{4\pi\epsilon_0} \frac{p}{(r^2)^{3/2}} = \frac{1}{4\pi\epsilon_0} \frac{p}{r^3}$$

i.e. electric field strength due to a short dipole at broadside on position

$$E = \frac{1}{4\pi\epsilon_0} \frac{p}{r^3}, \text{ parallel to } \mathbf{BA} \quad \dots(iv)$$

(b)

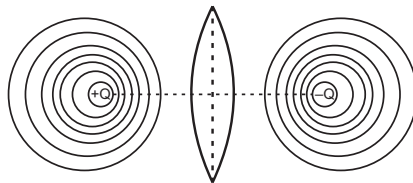

Electric potential is zero at all points in the plane passing through the dipole equator.

OR

- (i) **Electric field intensity at a point outside a uniformly charged thin spherical shell:** Consider a uniformly charged thin spherical shell of radius R carrying charge Q . To find the electric field outside the shell, we consider a spherical Gaussian surface of radius r ($r > R$),

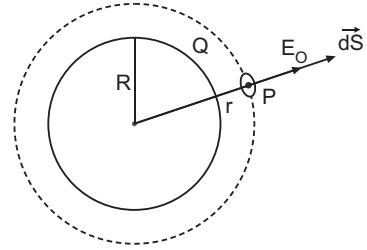

concentric with given shell. If \mathbf{E} is electric field outside the shell, then by symmetry electric field strength has same magnitude E_0 on the Gaussian surface and is directed radially outward. Also the directions of normal at each point is radially outward, so angle between \mathbf{E}_i and $d\mathbf{S}$ is zero at each point. Hence, electric flux through Gaussian surface

$$\oint_S \mathbf{E}_0 \cdot d\mathbf{S}$$

$$= E_0 \int_S \cos 0 \cdot dS = E_0 \cdot 4\pi r^2$$

Now, Gaussian surface is outside the given charged shell, so charge enclosed by Gaussian surface is Q .

Hence, by Gauss's theorem

$$\oint_S \mathbf{E}_0 \cdot d\mathbf{S} = \frac{1}{\epsilon_0} \text{charge enclosed}$$

$$E_0 \cdot 4\pi r^2 = \frac{1}{\epsilon_0} Q \quad E_0 = \frac{1}{4\pi \epsilon_0} \frac{Q}{r^2}$$

Thus, **electric field outside a charged thin spherical shell is the same as if the whole charge Q is concentrated at the centre.**

If σ is the surface charge density of the spherical shell, then

$$Q = 4\pi R^2 \sigma$$

$$E_0 = \frac{1}{4\pi \epsilon_0} \frac{4\pi R^2 \sigma}{r^2} = \frac{R^2 \sigma}{\epsilon_0 r^2}$$

- (ii) **Electric field inside the shell (hollow charged conducting sphere):** The charge resides on the surface of a conductor. Thus a hollow charged conductor is equivalent to a charged spherical shell. To find the electric field inside the shell, we consider a spherical Gaussian surface of radius r ($r < R$), concentric with the given shell. If \mathbf{E} is the electric field inside the shell, then by symmetry electric field strength has the same magnitude E_i on the Gaussian surface and is directed radially outward. Also the

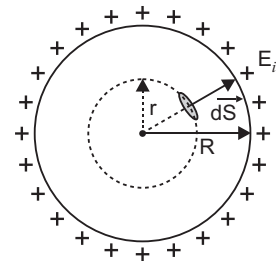

directions of normal at each point is radially outward, so angle between \mathbf{E}_i and $d\mathbf{S}$ is zero at each point. Hence, electric flux through Gaussian surface

$$\oint_S \mathbf{E}_i \cdot d\mathbf{S}$$

$$= E_i \int_S \cos 0 \cdot dS = E_i \cdot 4\pi r^2$$

Now, Gaussian surface is inside the given charged shell, so charge enclosed by Gaussian surface is zero.

Hence, by Gauss's theorem

$$\oint_S \mathbf{E}_i \cdot d\mathbf{S} = \frac{1}{\epsilon_0} \text{charge enclosed}$$

$$E_i \cdot 4\pi r^2 = \frac{1}{\epsilon_0} \cdot 0 \quad E_i = 0$$

Thus, *electric field at each point inside a charged thin spherical shell is zero. The graph is shown in fig.*

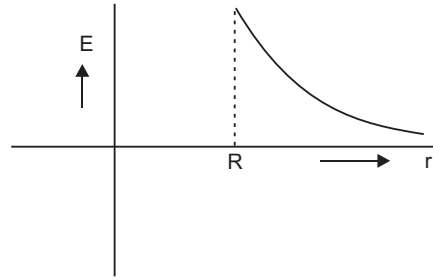

29. Expression for frequency of radiation

Suppose m be the mass of an electron and v be its speed in n th orbit of radius r . The centripetal force for revolution is produced by electrostatic attraction between electron and nucleus.

$$\frac{mv^2}{r} = \frac{1}{4\pi\epsilon_0} \frac{(Ze)(e)}{r^2} \quad \dots (i)$$

or,
$$mv^2 = \frac{1}{4\pi\epsilon_0} \frac{Ze^2}{r}$$

So, Kinetic energy $[K] = \frac{1}{2}mv^2$

$$K = \frac{1}{4\pi\epsilon_0} \frac{Ze^2}{2r}$$

$$\text{Potential energy} = \frac{1}{4\pi\epsilon_0} \frac{(Ze)(-e)}{r} = -\frac{1}{4\pi\epsilon_0} \frac{Ze^2}{r}$$

Total energy,

$$E = KE + PE = \frac{1}{4\pi\epsilon_0} \frac{Ze^2}{2r} - \frac{1}{4\pi\epsilon_0} \frac{Ze^2}{r}$$

$$E = -\frac{1}{4\pi\epsilon_0} \frac{Ze^2}{2r}$$

For n th orbit, E can be written as E_n

so,
$$E_n = -\frac{1}{4\pi\epsilon_0} \frac{Ze^2}{2r_n} \quad \dots(ii)$$

Again from Bohr's postulate for quantization of angular momentum.

$$mvr = \frac{nh}{2\pi} \quad v = \frac{nh}{2\pi mr}$$

Substituting this value of v in equation (i), we get

$$\frac{m}{r} \left(\frac{nh}{2\pi mr} \right)^2 = \frac{1}{4\pi\epsilon_0} \frac{Ze^2}{r^2}$$

or,
$$r = \frac{0h^2n^2}{mZe^2} \quad \text{or} \quad r_n = \frac{0h^2n^2}{mZe^2} \quad \dots(iii)$$

Substituting value of r_n in equation (ii), we get

$$E_n = \frac{1}{4} \frac{Ze^2}{2} \frac{mZ^2e^4}{h^2n^2} = \frac{mZ^2e^4}{8h^2n^2}$$

or,
$$E_n = \frac{Z^2Rhc}{n^2}, \text{ where } R = \frac{me^4}{8ch^3}$$

R is called Rydberg constant.

For hydrogen atom $Z = 1$,

$$E_n = \frac{Rhc}{n^2}$$

If n_i and n_f are the quantum numbers of initial and final states and E_i & E_f are energies of electron in H-atom in initial and final state, we have

$$E_i = \frac{Rhc}{n_i^2} \text{ and } E_f = \frac{Rhc}{n_f^2}$$

If ν is the frequency of emitted radiation.

we get
$$\frac{E_i - E_f}{h}$$

$$\frac{Rc}{n_i^2} - \frac{Rc}{n_f^2} = Rc \left(\frac{1}{n_f^2} - \frac{1}{n_i^2} \right)$$

If electron jumps from $n_i = 4$ to $n_f = 3, 2, 1$ radiation belongs to Paschen, Balmer and Lyman series.

OR

(a) Graphical variation of (BE/A) for nucleons with mass number A .

The variation of binding energy per nucleon versus mass number is shown in figure.

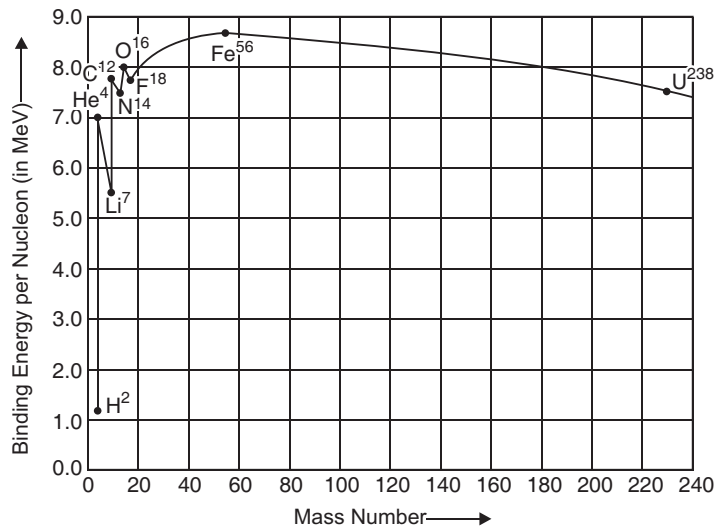

Conclusions:

- (i) Nuclear forces non-central and short ranged force.
- (ii) Nuclear forces between proton-neutron and neutron-neutron are strong and attractive in nature.

(b) **Explanation of Nuclear Fission:** When a heavy nucleus ($A = 235$ say) breaks into two lighter nuclei (nuclear fission), the binding energy per nucleon increases *i.e.*, nucleons get more tightly bound. This implies that energy would be released in nuclear fission.

Explanation of Nuclear Fusion: When two very light nuclei ($A = 10$) join to form a heavy nucleus, the binding energy per nucleon of fused heavier nucleus more than the binding energy per nucleon of lighter nuclei, so again energy would be released in nuclear **fusion**.

(c) During decay of a neutron, we have

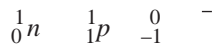

The detection of neutrinos is very difficult because it shows weak interactions with other particles.

SET-II

4. $\frac{-Q}{0}$

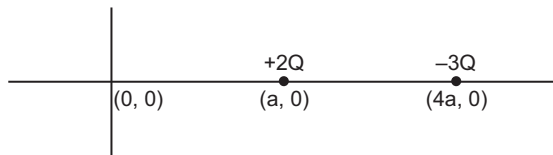

Draw a sphere of radius $5a$ about origin 'O' and on applying Gauss's Theorem.

$$\frac{Q_i}{0}$$

7. A metal disc is placed on the top of a magnet, as the electric current flows through the coil, an induced current in the form of eddies flows through the metal plate, the lower face attains the same polarity, and hence the metal disc is thrown up.

9. (i) AND Gate
(ii) Truth Table

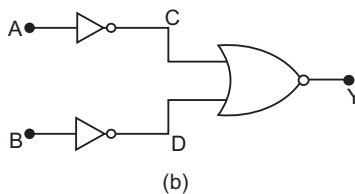

A	B	$y \overline{A} \overline{B}$
0	0	0
1	0	0
0	1	0
1	1	1

13. d. n

$$d \frac{y}{D} n$$

For first minima $n = 1$

$$d \frac{D}{y}$$

$$\frac{1.2 \cdot 600 \cdot 10^{-9}}{3 \cdot 10^{-3}}$$

$$2.4 \cdot 10^{-4} \text{ m}$$

19. In stable equilibrium

$$\frac{F_{\text{repulsion}}}{2} = \frac{m g}{r}$$

$$\frac{m}{l} = \frac{\mu_0 I_1 I_2}{2 r g}$$

$$\frac{2 \cdot 10^{-7} \cdot 10 \cdot 6}{2 \cdot 10^{-3} \cdot 10}$$

$$6 \cdot 10^{-4} \text{ kg/m}$$

Current in both wires should be opposite, so both conductors repel each other.

23. Maximum distance between transmitting antenna and receiving antenna

$$d_{\text{max}} = \sqrt{2R h_T} \sqrt{2R h_R}$$

$$= \sqrt{2 \cdot 6.4 \cdot 10^6 \cdot 80} \sqrt{2 \cdot 6.4 \cdot 10^6 \cdot 45}$$

$$= (\sqrt{1024} \sqrt{576}) \cdot 10^3$$

$$= (32 \cdot 24) \cdot 10^3$$

$$= 56 \cdot 10^3 \text{ m}$$

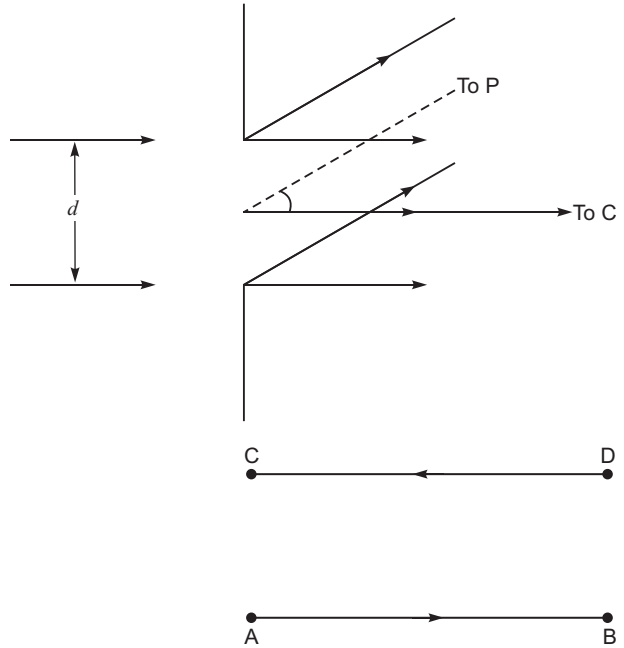

Set-III

3. $T = \frac{4Q}{0}$

For sphere of radius '2a' charge -Q is outside the Gaussian surface. So $T = \frac{4Q}{0}$

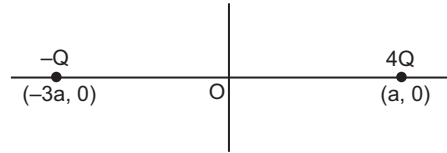

- 4. Decreases
- 6. (i) Mutual inductance increases.
(ii) Mutual inductance decreases.
- 9. (i) AND Gate
(ii)

Truth Table

A	B	$y = \overline{\overline{A} \overline{B}}$
0	0	0
1	0	0
0	1	0
1	1	1

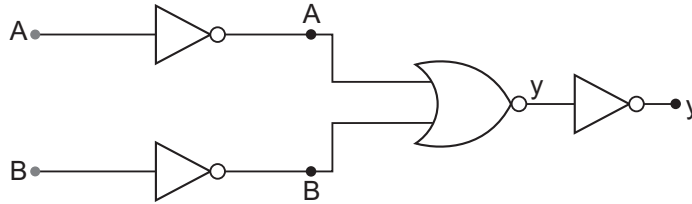

Extended Truth Table

A	B	\overline{A}	\overline{B}	$y = \overline{\overline{A} \overline{B}}$	$y = \overline{\overline{\overline{\overline{A} \overline{B}}}}$
0	0	1	1	1	0
1	0	0	1	1	0
0	1	1	0	1	0
1	1	0	0	0	1

15. Capacitance of parallel plate capacitor filled with dielectric:

$$C = \frac{\epsilon_0 A}{(d-t) \frac{t}{k}}$$

Since thickness $t = \frac{2d}{3}$

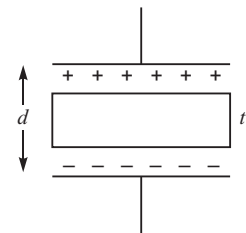

$$C = \frac{0A}{d - \frac{2d}{3} - \frac{2d}{3k}}$$

$$\frac{0A}{\frac{d}{3} - \frac{2d}{3k}}$$

$$\frac{3k \cdot 0A}{d(k - 2)}$$

25. Maximum distance between transmitting antenna and receiving antenna,

$$d_{\max} = \sqrt{2Rh_T} + \sqrt{2Rh_R}$$

Since $h_R = 0$

$$d_{\max} = \sqrt{2 \cdot 6.4 \cdot 10^6} + 45$$

$$= \sqrt{9 \cdot 64 \cdot 10^6}$$

$$= 3 \cdot 8 \cdot 10^3$$

$$= 24 \cdot 10^3 \text{ m}$$

CBSE Examination Papers

Foreign–2013

SET-I

Time allowed : 3 hours

Maximum marks: 70

General Instructions: As given in CBSE Examination Paper Delhi–2013.

1. Define electric dipole moment. Is it scalar or vector?
2. On what factors does the magnitude of the emf induced in the circuit due to magnetic flux depend?
3. Write the function of a transmitter in a communication system.
4. A ray of monochromatic light passes from medium (1) to medium (2). If the angle of incidence in medium (1) is i and the corresponding angle of refraction in medium (2) is $i/2$, which of the two media is optically denser? Give reason.
5. Why are broadcast frequencies (carrier waves) sufficiently spaced in amplitude modulated wave?
6. Plot a graph showing the variation of resistance of a conducting wire as a function of its radius, keeping the length of the wire and its temperature as constant.
7. Two materials Si and Cu, are cooled from 300 K to 60 K. What will be the effect on their resistivity?
8. A long straight wire carries a steady current I along the positive y-axis in a coordinate system. A particle of charge $+Q$ is moving with a velocity v along the x-axis. In which direction will the particle experience a force?
9. Calculate the value of the current drawn from a 5 V battery in the circuit as shown.

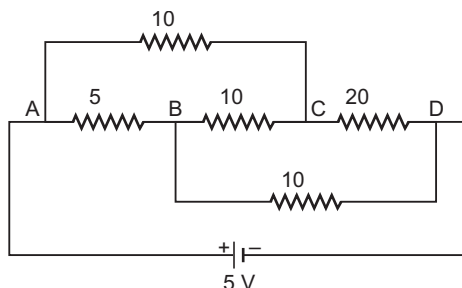

10. Two concentric metallic spherical shells of radii R and $2R$ are given charges Q_1 and Q_2 respectively. The surface charge densities on the outer surfaces of the shells are equal. Determine the ratio $Q_1 : Q_2$.
11. Three rays of light, red (R), green (G) and blue (B), are incident on the face AB of a right angled prism, as shown in the figure. The refractive indices of the material of the prism for red, green and blue are 1.39, 1.44 and 1.47 respectively. Which one of the three rays will emerge out of the prism? Give reason to support your answer.

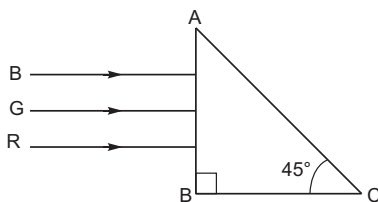

12. A resistor 'R' and an element 'X' are connected in series to an ac source of voltage. The voltage is found to lead the current in phase by $\pi/4$. If 'X' is replaced by another element 'Y', the voltage lags behind the current by $\pi/4$.
- Identify elements 'X' and 'Y'.
 - When both 'X' and 'Y' are connected in series with 'R' to the same source, will the power dissipated in the circuit be maximum or minimum? Justify your answer.

OR

A series LCR circuit is connected to an ac source (200 V, 50 Hz). The voltages across the resistor, capacitor and inductor are respectively 200 V, 250 V and 250 V.

- The algebraic sum of the voltages across the three elements is greater than the voltage of the source. How is this paradox resolved?
 - Given the value of the resistance of R is $40\ \Omega$, calculate the current in the circuit.
13. Ultraviolet light of wavelength $2271\ \text{\AA}$ from 100 W mercury source irradiates a photocell made of molybdenum metal. If the stopping potential is $-1.3\ \text{V}$, estimate the work function of the metal. How would the photocell respond when the source is replaced by another source of high intensity ($\sim 10^5\ \text{W m}^{-2}$) red light of wavelength $6328\ \text{\AA}$ Justify your answer.
14. The circuit shown in the figure has two oppositely connected ideal diodes connected in parallel. Find the current flowing through each diode in the circuit.

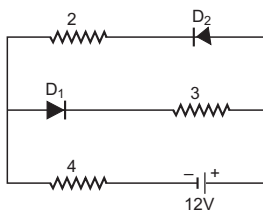

- Find the ratio of their momenta.
 - Compare the kinetic energy of the proton with that of the electron.
16. A parallel plate capacitor, each of plate area A and separation 'd' between the two plates, is charged with charges $+Q$ and $-Q$ on the two plates. Deduce the expression for the energy stored in the capacitor.
17. In an experiment on α particle scattering by a thin foil of gold, draw a plot showing the number of particles scattered versus the scattering angle θ .
Why is it that a very small fraction of the particles are scattered at 90° ?
Write two important conclusions that can be drawn regarding the structure of the atom from the study of this experiment.

OR

Derive the expression for the law of radioactive decay of a given sample having initially N_0 nuclei decaying to the number N present at any subsequent time t .

Plot a graph showing the variation of the number of nuclei versus the time t lapsed.

Mark a point on the plot in terms of $T_{1/2}$ value when the number present $N = N_0/16$.

18. Give reasons for the following:

Calculate:

(i) For ground wave transmission, size of antenna should be comparable to the wavelength of the signal, e.g. \sim

(ii) Audio signals converted into electromagnetic waves are not transmitted as such directly.

(iii) The amplitude of modulating signal is kept less than that of the carrier wave.

19. (a) An infinitely long positively charged straight wire has a linear charge density λ cm^{-1} . An electron is revolving around the wire as its centre with a constant velocity in a circular plane perpendicular to the wire. Deduce the expression for its kinetic energy.

(b) Plot a graph of the kinetic energy as a function of charge density λ .

20. (a) (i) A circular loop of area A , carrying a current I is placed in a uniform magnetic field B . Write the expression for the torque acting on it in a vector form.

(ii) If the loop is free to turn, what would be its orientation of stable equilibrium? Show that in this orientation, the flux of net field (external field + the field produced by the loop) is maximum.

(b) Find out the expression for the magnetic field due to a long solenoid carrying a current I and having n number of turns per unit length.

21. (i) Draw a schematic labelled ray diagram of a reflecting type telescope.

(ii) Write two important advantages justifying why reflecting type telescopes are preferred over refracting telescopes.

(iii) The objective of a telescope is of larger focal length and of larger aperture (compared to the eyepiece). Why? Give reasons.

22. (a) State, with the help of a suitable diagram, the principle on which the working of a meter bridge is based.

(b) Answer the following:

(i) Why are the connections between resistors in a meter bridge made of thick copper strips?

(ii) Why is it generally preferred to obtain the balance point near the middle of the bridge wire in meter bridge experiments?

23. (a) How are electromagnetic waves produced by oscillating charges?

(b) State clearly how a microwave oven works to heat up a food item containing water molecules.

(c) Why are microwaves found useful for the radar systems in aircraft navigation?

24. (a) The energy levels of a hypothetical hydrogen-like atom are shown in the figure. Find out the transition, from the ones shown in the figure, which will result in the emission of a photon of wavelength 275 nm.

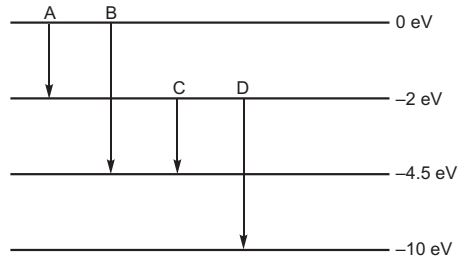

- (b) Which of these transitions corresponds to the emission of radiation of (i) maximum and (ii) minimum wavelength?
25. When unpolarised light is incident on the boundary separating the two transparent media, explain, with the help of a suitable diagram, the conditions under which the reflected light gets polarised. Hence define Brewster's angle and write its relationship in terms of the relative refractive index of the two media.
26. Kamal's uncle was advised by his doctor to undergo an MRI scan test of his chest and gave him an estimate of the cost. Not knowing much about the significance of this test and finding it to be too expensive he first hesitated. When Kamal learnt about this, he decided to take help of his family, friends and neighbours and arranged for the cost. He convinced his uncle to undergo this test so as to enable the doctor to diagnose the disease. he got the test done and the resulting information greatly helped the doctor to give him proper treatment.
- (a) What, according to you, are the values displayed by Kamal, his family, friends and neighbours?
- (b) Assuming that the MRI scan test involved a magnetic field of 0.1 T, find the maximum and minimum values of the force that this field could exert on a proton moving with a speed of 10^4 ms^{-1} . State the condition under which the force can be minimum.
27. Using phasor diagram for a series LCR circuit connected to an ac source of voltage $v = v_0 \sin$ derive the relation for the current flowing in the circuit and the phase angle between the voltage across the resistor and the net voltage in the circuit.
- Draw a plot showing the variation of the current I as a function of angular frequency ' ω ' of the applied ac source for the two cases of a series combination of (i) inductance L_1 , capacitance C_1 and resistance R_1 and (ii) inductance L_2 , capacitance C_2 and resistance R_2 where $R_2 > R_1$.
- Write the relation between L_1, C_1 and L_2, C_2 at resonance. Which one, of the two, would be better suited for fine tuning in a receiver set? Give reason.

OR

- (a) Define the term 'mutual inductance'.
- Deduce the expression for the mutual inductance of two long coaxial solenoids having different radii and different number of turns.
- (b) A coil is mechanically rotated with constant angular speed in a uniform magnetic field which is perpendicular to the axis of rotation of the coil. The plane of the coil is initially held perpendicular to the field. Plot a graph showing variation of (i) magnetic flux and (ii) the induced emf in the coil as a function of
28. (a) A monochromatic source of light of wavelength illuminates a narrow slit of width d to produce a diffraction pattern on the screen. Obtain the conditions when secondary wavelets originating from the slit interfere to produce maxima and minima on the screen.

- (b) How would the diffraction pattern be affected when
- the width of the slit is decreased?
 - the monochromatic source of light is replaced by white light?

OR

A thin convex lens having two surfaces of radii of curvature R_1 and R_2 is made of a material of refractive index μ_2 . It is kept in a medium of refractive index μ_1 . Derive, with the help of a ray diagram, the lens maker formula when a point object placed on the principal axis in front of the radius of curvature R_1 produces an image I on the other side of the lens.

29. (a) Distinguish between an intrinsic semiconductor and a p-type semiconductor. Give reason why a p-type semiconductor is electrically neutral, although $n_h \gg n_e$.
- (b) Explain, how the heavy doping of both p-and n-sides of a p-n junction diode results in the electric field of the junction being extremely high even with a reverse bias voltage of a few volts.

Explain, with the help of a circuit diagram, how this property is used in voltage regulator.

OR

Draw the circuit arrangement for studying the input and output characteristics of n-p-n transistor in CE configuration.

Draw the typical nature of these input and output characteristics. Explain how these are obtained.

Define the terms (i) input resistance and (ii) current amplification factor.

SET-II

Questions Uncommon to Set-I

- When a charged particle moving with velocity v is subjected to magnetic field B , the force acting on it is non-zero. Would the particle gain any energy?
- Two materials, Ge and Al, are cooled from 300K to 60 K. What will be the effect on their resistivity?
- Two concentric metallic spherical shells of radii R and $3R$ are given charges Q_1 and Q_2 respectively. The surface charge densities on the outer surfaces of the shells are equal. Determine the ratio $Q_1 : Q_2$.
- In the circuit shown in the figure, the galvanometer 'G' gives zero deflection. If the batteries A and B have negligible internal resistance, find the value of the resistor R .

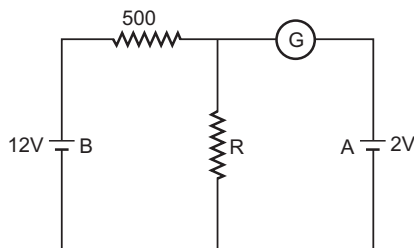

- The circuit shown in the figure contains two diodes each with a forward resistance of 50Ω and infinite backward resistance. Calculate the current in the 100Ω resistance?

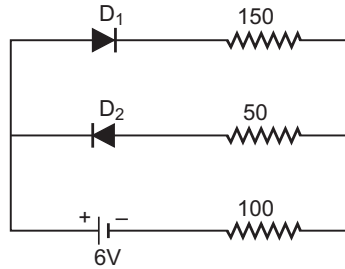

21. Write the generalised expression for the Ampere's circuital law in terms of the conduction current and the displacement current. Mention the situation when there is:
- only conduction current and no displacement current.
 - displacement current and no conduction current.
22. (a) Draw a labelled ray diagram of a compound microscope.
 (b) Derive an expression for its magnifying power.
 (c) Why is objective of a microscope of short aperture and short focal length? Give reason.

SET-III

Questions Uncommon to Set-I and Set-II

4. Two materials, Ag and GaAs, are cooled from 300 K to 60 K. What will be the effect on the resistivity?
5. In a certain region of space, electric field E and magnetic field B are perpendicular to each other. An electron enters in the region perpendicular to the directions of both B and E and moves undeflected. Find the velocity of the electron.
10. What will be the value of current through the 2 ohm resistance for the circuit shown in the figure? Give reason to support your answer.

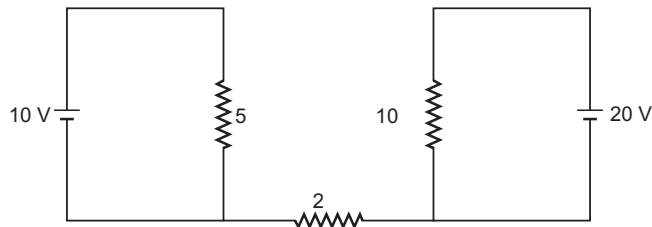

13. The circuit shown in the figure contains two diodes each with a forward resistance of 50 ohm and infinite backward resistance. Calculate the current in the 100 ohm resistance.

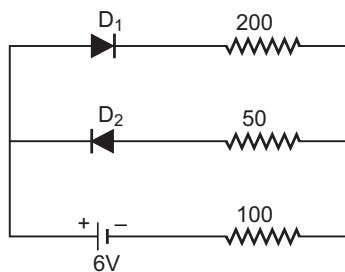

18. (a) Why are infra-red radiations referred to as heat waves? Name the radiations which are next to these radiations in the electromagnetic spectrum having (i) shorter wavelength (ii) longer wavelength.
- (b) State the conditions under which a microwave oven heats up a food item containing water molecules.
19. (a) Draw a labelled ray diagram of a refraction type telescope in normal adjustment.
- (b) Give its two shortcomings over reflection type telescope.
- (c) Why is eyepiece of a telescope of short focal length, while objective is of large focal length? Explain.



CBSE (Foreign) SET-I

- The product of the magnitude of either charge and shortest distance between the opposite charges. It is a vector quantity and its direction is from negative charge towards positive charge.

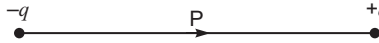

- Depends on the time rate of change in magnetic flux (or simply change in magnetic flux)

$$\left| \frac{d\phi}{dt} \right|$$

- Processes the incoming message signal on suitable carrier waves. So as to make it suitable for transmission through a channel.
- Medium (2) is optically denser.
Reason - angle of refraction is less than the angle of incidence.

OR

Angle of refraction decreases, as the refractive index of the medium decreases.

$$n_1 \sin i = n_2 \sin r \quad (n_2 < n_1)$$

- To avoid mixing up of signals from different transmitters. This can be done by modulating the signals on high frequency carrier waves, e.g. frequency band for satellite communication is 5.925– 6.425 GHz.

- Resistance of a conductor of length l , and radius r is given by

$$R = \frac{\rho l}{r^2}$$

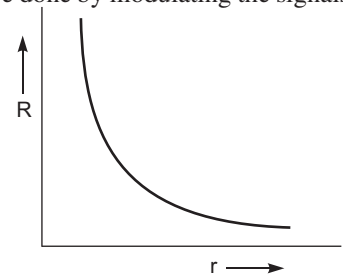

- In silicon, the resistivity increases
In copper, the resistivity decreases.

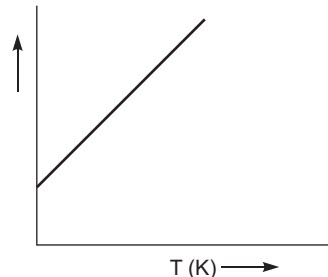
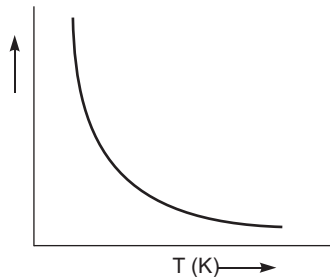

8. From relation $\vec{F} = qv [\hat{i} \times (-\hat{k})] = +qvB(\hat{j})$

Magnetic force \vec{F} along + y axis.

OR

From Fleming's left hand rule, thumb points along + y direction, so the direction of magnetic force will be along + y axis (or in the direction of flow of current).

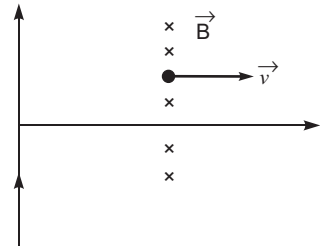

9. In case of balanced Wheatstone bridge, no current flows through the resistor 10 Ω between points B and C.

The resistance of arm ACD, $R_{S_1} = 10 + 20 = 30 \Omega$

The resistance of arm ABD, $R_{S_2} = 5 + 10 = 15 \Omega$

$$\text{Equivalent resistance } R_{eq} = \frac{R_{S_1} R_{S_2}}{R_{S_1} + R_{S_2}} = \frac{30 \times 15}{30 + 15} = 10 \Omega$$

Current drawn from the source,

$$I = \frac{V}{R_{eq}} = \frac{5}{10} = \frac{1}{2} \text{ A} = 0.5 \text{ A}$$

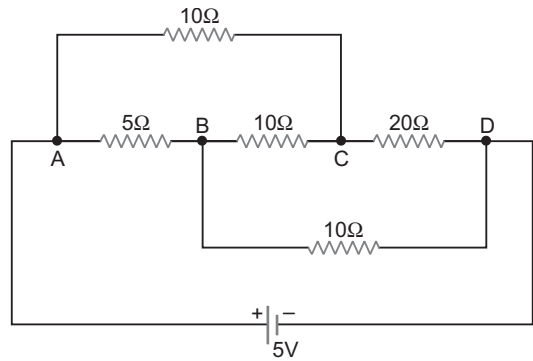

10. Surface charge density = constant

Charge $Q_1 = 4 \pi R^2 \sigma$

Charge $Q_2 = 4 \pi (2R)^2 \sigma$

$$\frac{Q_1}{Q_2} = \frac{4 \pi R^2 \sigma}{4 \pi (2R)^2 \sigma} = \frac{1}{4}$$

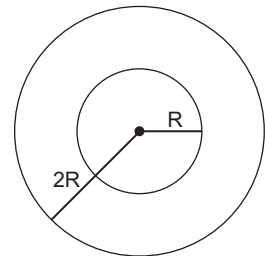

11. If angle of incidence 'i' is less than the critical angle of glass-air interface AC then it will emerge out.

Critical angle $\sin i_C = \frac{1}{\mu}$

$$\frac{1}{\sin i_C} = \frac{1}{\sin 45^\circ} = \sqrt{2} = 1.414$$

Since $\mu_R = 1.39$, $\mu_G = 1.44$ and $\mu_B = 1.47$, so from equation (1) angle of incidence for red colour $i_C > 45^\circ$ while angle of incidence for blue and green colours $i_C < 45^\circ$, hence blue and green colour rays will emerge out.

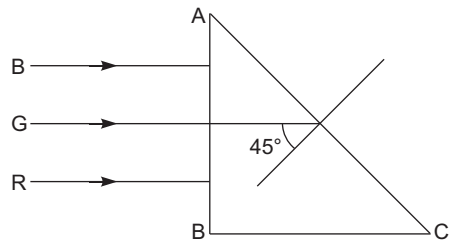

12. (i) In R-L series combination, voltage leads the current by phase $\frac{\pi}{4}$. It means element x is an inductor. In R.C. series combination, voltage lags behind the current by phase $\frac{\pi}{4}$. So element y is a capacitor.

- (ii) If both elements x and y are connected in series with R, than power dissipation in the combination can be given as

$$P = V_{\text{eff}} \cdot I_{\text{eff}} \cdot \cos$$

$\cos < 1$ for reactance of elements x and y are not equal.
Hence power dissipation would be minimum.

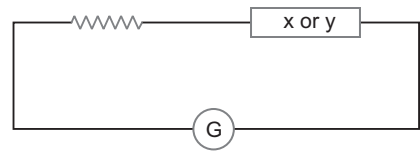

OR

- (i) From given parameters $V_R = 200V$, $V_L = 250 V$ and $V_C = 250 V$

V_{eff} should be given as

$$V_{\text{eff}} = V_R + V_L + V_C = 200 V + 250V + 250 V = 700 V$$

However, $V_{\text{eff}} > 200 V$ of the ac source.

This paradox can be solved only by using phasor diagram, as given below:

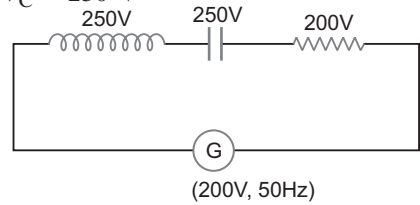

$$(V_{\text{eff}}) = \sqrt{V_R^2 + (V_L - V_C)^2}$$

Since $V_L = V_C$ so $V_{\text{eff}} = V_R = 200V$

- (ii) Given $R = 40 \Omega$, so current in the LCR circuit.

$$I_{\text{eff}} = \frac{V_{\text{eff}}}{R} \quad [X_L = X_C \text{ or } Z = R]$$

$$= \frac{200}{40} = 5 \text{ A}$$

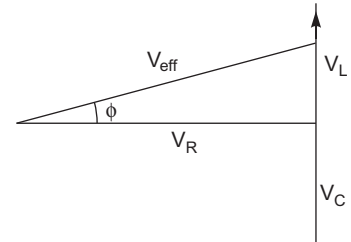

- 13.** From Einstein's equation $h\nu = eV_s$

or $h\nu = eV_s + \frac{hc}{d}$ eV_s (Equation is independent to the power of the source)

$$\frac{6.6 \times 10^{-34} \times 3 \times 10^8}{2271 \times 10^{-10}} = 13eV$$

$$= \frac{6.6 \times 10^{-34} \times 3 \times 10^8}{2271 \times 10^{-10} \times 1.6 \times 10^{-19}} eV = 13 eV$$

$$= 5.5 eV - 1.3 eV = 4.2 eV$$

● Threshold frequency $\nu_0 = \frac{0}{h} + \frac{4.2eV}{6.6 \times 10^{-34}}$

$$= \frac{4.2 \times 1.6 \times 10^{-19}}{6.6 \times 10^{-34}}$$

$$= 1.0 \times 10^{15} \text{ Hz}$$

and the frequency of red light from source 10^5 W/m^2

$$\frac{c}{\lambda} = \frac{3 \times 10^8}{6238 \times 10^{-10}}$$

$$= 4.7 \times 10^{14} \text{ Hz}$$

Since frequency of red light is less than threshold frequency so photocell will not respond to red light, howsoever high (10^5 W/m^2) be the intensity of light.

14. (i) Diode D_1 is reverse biased, so it offers an infinite resistance. So no current flows in the branch of diode D_1 .
 (ii) Diode D_2 is forward biased, and offers no resistance in the circuit. So current in the branch

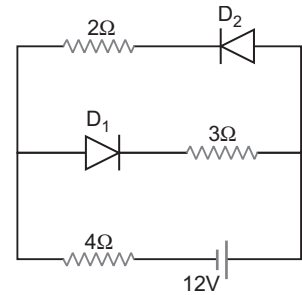

$$I = \frac{V}{R_{\text{eq}}} = \frac{12V}{2 + \frac{3 \times 4}{3+4}} = 2 \text{ A}$$

15. (i) $e \frac{h}{P_e}$ and $p \frac{h}{P_p}$, $e \quad p = 1.00 \text{ nm}$

$$\text{So, } \frac{e}{p} = \frac{P_p}{P_e} = \frac{1}{1}$$

$$\frac{P_p}{P_e} = \frac{1}{1} \quad 1:1$$

- (ii) From relation $K = \frac{1}{2}mv^2 = \frac{p^2}{2m}$

$$K_e = \frac{p_e^2}{2m_e} \text{ and } K_p = \frac{p_p^2}{2m_p}$$

$$\frac{K_p}{K_e} = \frac{p_p^2}{2m_p} \cdot \frac{2m_e}{p_e^2} = \frac{m_e}{m_p}$$

Since $m_e \ll m_p$. So $K_p \ll K_e$.

$$\frac{K_p}{K_e} = \frac{9.1 \times 10^{-31}}{1.67 \times 10^{-27}} = 5.4 \times 10^{-4}$$

16. Q and $-q$ are charges on the plates and produces a uniform electric field $E = \frac{Q}{\epsilon_0 A}$ between the plates and a potential difference $V = \frac{q}{C}$... (i)

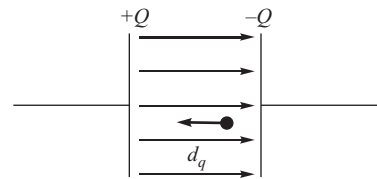

If a charge dq is transported in steps from negative charged plate to +ve charged plate, till charges rises to $+Q$ and $-Q$, then

$$\text{Workdone } dW = dq \cdot V \quad \dots \text{ (ii)}$$

From equations (1) and (2)

$$dW = dq \left(\frac{q}{C} \right)$$

Total electrostatic potential energy stored can be given as

$$U = \int_0^Q \frac{q}{C} \cdot dq = \frac{Q^2}{2C}$$

$$U = \frac{Q^2}{2C}$$

17. A small fraction of the alpha particles scattered at angle 90° is due to the following reasons.

(i) If impact parameter 'b' reduces to zero, coulomb force increases, and hence alpha particles are scattered at angle 90° , and only one alpha particle is scattered at angle 180° .

Conclusions:

(i) Entire positive charge and most of the mass of the atom is concentrated in the nucleus with the electrons some distance away.

(ii) Size of the nucleus is about 10^{-15} m to 10^{-14} m, while size of the atom 10^{-10} m, so the electrons are at distance 10^4 m to 10^5 m from the nucleus, and being large empty space in the atom, most particles go through the empty space.

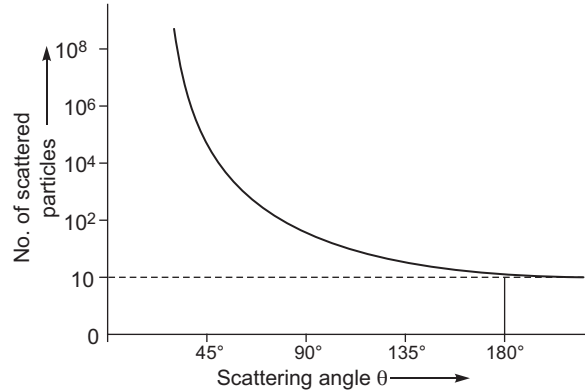

OR

Let N be the number of undecayed nuclei in the sample at time t and N nuclei undergo decay in time t. Then,

$$\frac{dN}{dt} = -\lambda N$$

where λ is disintegration constant.

The rate of change in N in time t can be expressed as $\frac{dN}{dt} = -\lambda N$

On integrating both sides

$$\int_{N_0}^N \frac{dN}{N} = \int_0^t -\lambda dt$$

where N_0 is initial undecayed nuclei.

$$(\ln N) \frac{N}{N_0} = -\lambda t$$

$$\ln \frac{N}{N_0} = -\lambda t$$

$$N = N_0 e^{-\lambda t}$$

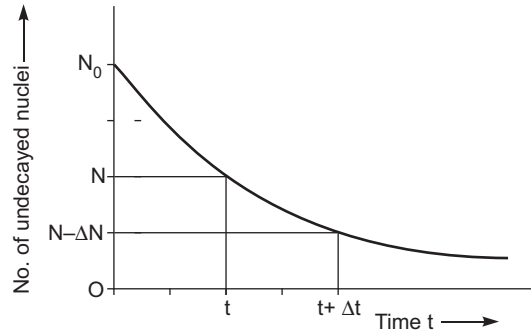

Mark of $N \frac{N_0}{16}$ in terms of $T_{1/2}$ is shown in fig.

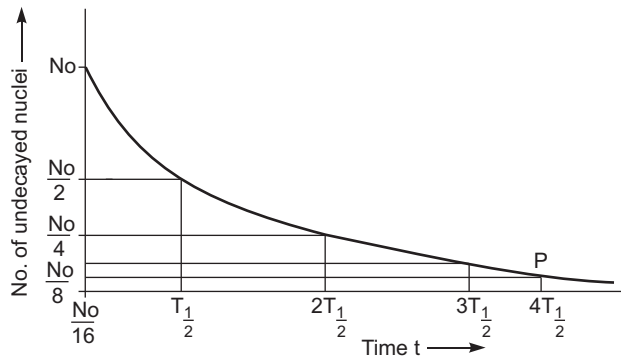

18. Ground wave propagation is possible for radio waves of frequency band 540kHz – 1600 kHz (or max. 2 MHz)

If a base band signal of frequency 20 kHz, wavelength of the wave must be $\lambda = 15$ km, obviously antenna of size $l = 3.75$ km is not possible to construct and operate.

If base band signals are translated into high frequency radio wave of frequency f MHz, then antenna of few metre can be constructed and can be used in sending the information along the ground.

- (i) Low size of the antenna is required for waves of short wavelength and hence comparable.
- (ii) Audio signals of large wavelength cannot be send directly, because large size antenna is required.

- (iii) Modulation index $\frac{V_m}{V_C}$, and its value should be less than 1, other distortion will produce in the wave.

19. (a) Infinitely long charged wire produces a radial electric field.

$$E = \frac{\lambda}{2\pi\epsilon_0 r} \dots (1)$$

The revolving electron experience an electrostatic force and provides necessarily centripetal force.

$$eE = \frac{mv^2}{r} \dots (2)$$

$$\frac{e \cdot \lambda}{2\pi\epsilon_0 r} = \frac{mv^2}{r}$$

$$mv^2 = \frac{e \lambda}{2\pi\epsilon_0}$$

Kinetic energy of the electron

$$K = \frac{1}{2}mv^2 = \frac{e \lambda}{4\pi\epsilon_0}$$

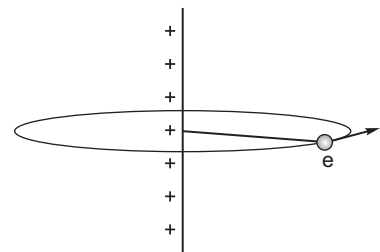

(b)

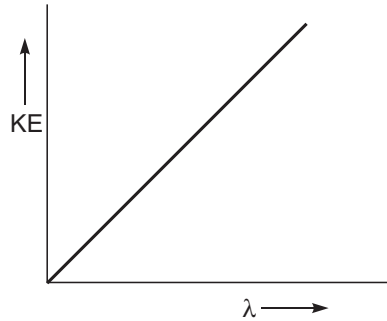

20. (a) (i) Torque acting on the current loop $\tau = m \times B = I(A \times B)$

(ii) If magnetic moment $m = IA$ is in the direction of external magnetic field *i.e.*, $\theta = 0^\circ$.

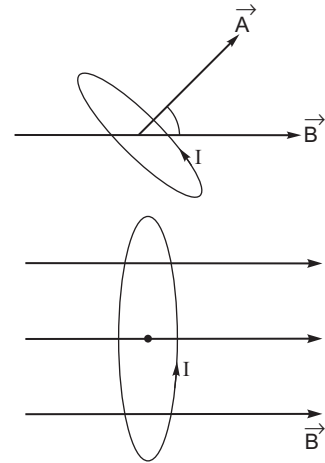

Magnetic flux $\Phi = B \cos \theta = B_C \cos \theta$

$$\Phi_{\max} = B \cos 0^\circ = B = \frac{\mu_0 I}{2r} \times \pi r^2 = \frac{\mu_0 I r}{2}$$

where r is radius of the loop.

(b) On applying Ampere's circuital law $\oint \vec{dl} = \mu_0 [Total\ current]$

$$\int_{PQ} \vec{dl} + \int_{QR} \vec{dl} + \int_{RS} \vec{dl} + \int_{SP} \vec{dl} = \mu_0 [n\ell I]$$

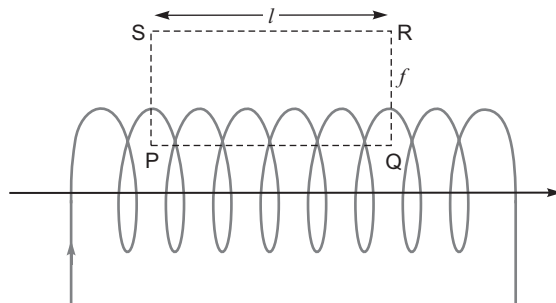

As no magnetic field exists in direction QR, RS and SP, so

$$\int_{PQ} \vec{dl} = \mu_0 n\ell I$$

$$\oint \vec{dl} = \mu_0 n\ell I$$

$$B \ell = \mu_0 n\ell I$$

$$B = \mu_0 n I$$

21. (i)

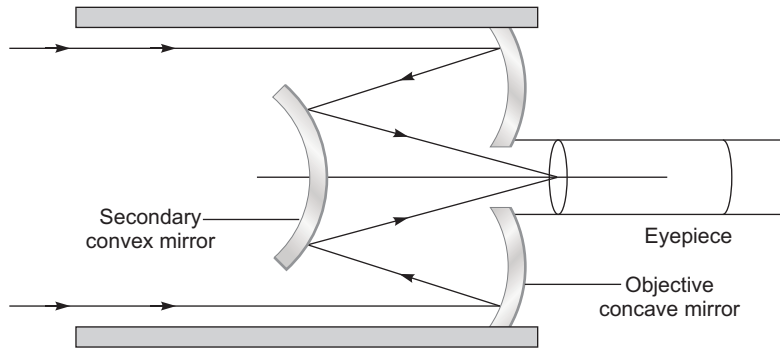

- (ii) Advantages :
- (a) Parabolic mirror is used to remove the spherical aberration.
 - (b) No chromatic aberration in mirror.
 - (c) Light mechanical support is required, because mirror weighs much less than a lens of equivalent optical quality.
- (iii) In normal adjustment, magnifying power of the telescope $M = \frac{F_o}{F_e}$.
- (a) If focal length of the objective lens is large in comparison to the eyepiece, magnifying power increases.
 - (b) Resolving power of the telescope $RP = \frac{\alpha}{1.22}$.

To increase the resolving power of the telescope, large aperture of the objective lens is required.

22. (a) If ratio of arms resistors in wheatstone bridge is constant, then no current flows through the galvanometer (or bridgewire).
- (b) (i) The resistivity of copper is several times less than the resistivity of the experimental alloy wire. As such area of thick copper strips is more, so copper strips almost offer zero resistance in the circuit.

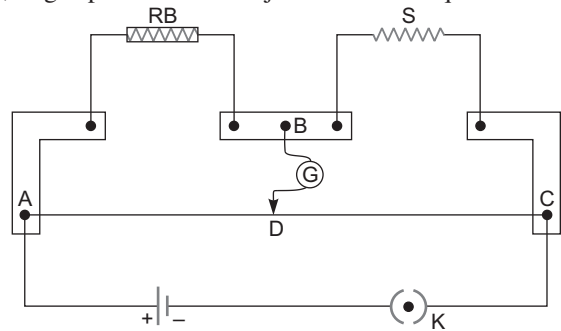

- (ii) If any one resistance in wheatstone bridge is either very small (or very large) in respect of other, then balance point might be very close to terminal A or terminal B. So generally balance point is taken in the middle of the bridge wire.
23. (a) If a charge particle oscillate with some frequency, produces an oscillating electric field in space, which produces an oscillating magnetic field, which in turn, is a source of electric field, and so on. Thus oscillating electric fields and magnetic fields regenerate each other, and an electromagnetic wave propagates in the space.
- (b) In microwave oven, the frequency of the microwaves is selected to match the resonant frequency of water molecules so that energy from the waves get transferred efficiently to the kinetic energy of the molecules. This kinetic energy raises the temperature of any food containing water.

(c) Microwaves are short wavelength radio waves, with frequency of order of GHz. Due to short wavelength, they have high penetrating power with respect to atmosphere and less diffraction in the atmospheric layers. So these waves are suitable for the radar systems used in aircraft navigation.

24. (a) The energy of photon of wavelength (275nm) in terms of eV can be given as

$$E = \frac{c}{\lambda} \quad eV$$

$$\frac{6.6 \times 10^{-34} \times 3 \times 10^8}{1.6 \times 10^{-19} \times 275 \times 10^{-9}}$$

$$\frac{19.8}{1.6 \times 275} \times 10^2 \quad eV = 4.5 \quad eV$$

The energy of photon in transition B E [0eV (4.5 eV)] = 4.5 eV.

Hence transition 'B' is possible.

- (b) The wavelength of the photon in a transition is given by $\frac{c}{E}$

(i) Maximum wavelength of photon is possible for transition having minimum E , so transition 'A' is possible with $E = 2eV$.

(ii) Minimum wavelength of the photon is possible for transition having maximum energy difference. So transition D is possible with $E = 10 \text{ eV}$.

25. When unpolarised light incident on the water molecules, the oscillating electrons in the water produces the reflected wave.

The double arrows are parallel to the direction of the reflected wave, so they do not contribute to the reflected wave; while dots are perpendicular to the plane of incidence and they get reflected and becomes linearly polarised light. This polarisation can be checked through an analyser.

The angle of incidence of unpolarised light at which (i) refracted wave and reflected wave becomes perpendicular to each other or (ii) reflected wave becomes totally polarised wave is called Brewster's angle.

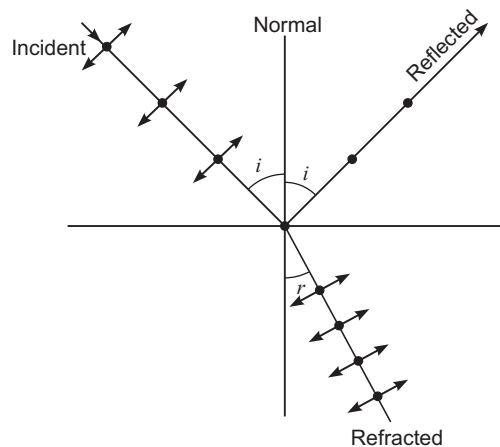

Let i_p be the angle of polarisation and $i_p + r = \frac{\pi}{2}$

Then from Snell's law

$$\frac{\sin i_p}{\sin r} = \frac{\sin i_p}{\sin(90^\circ - i_p)} = \tan i_p$$

26. (a) Values displayed by Kamal:

- (i) Being educated person knows about MRI (magnetic resonance imaging)
- (ii) Took prompt decisions to take the help of his family, friends and neighbours and arranged the cost of MRI.
- (iii) He shows his empathy, helping attitude and caring nature for his uncle.

(b) Magnetic force on moving charge particle in uniform magnetic field B can be given as

$$F = q(v \times B)$$

or $|F| = qvB \sin \theta$

(i) Maximum force at $\theta = 90^\circ$

$$\begin{aligned} F &= qvB \\ &= 1.6 \times 10^{-19} \times 10^4 \times 0.1 \\ &= 1.6 \times 10^{-16} \text{N} \end{aligned}$$

(ii) Minimum force at $\theta = 0^\circ$ and 180°

$$F = 0$$

i.e., charge particle either move parallel or antiparallel to the magnetic field lines.

27. (a) For I_{eff} flow of current through each element R, L and C, Effective voltage across the combination can be given as.

$$\begin{aligned} V_{\text{eff}} &= \sqrt{V_R^2 + (V_L - V_C)^2} \\ |V_{\text{eff}}| &= \sqrt{|V_R|^2 + (V_L - V_C)^2} \\ I_{\text{eff}} Z &= \sqrt{(I_{\text{eff}} R)^2 + (I_{\text{eff}} X_L - I_{\text{eff}} X_C)^2} \\ |Z| &= \sqrt{R^2 + (X_L - X_C)^2} \end{aligned}$$

$$\text{Effective current flow } I_{\text{eff}} = \frac{E_{\text{eff}}}{Z} = \frac{E_{\text{eff}}}{\sqrt{R^2 + (X_L - X_C)^2}}$$

Phase angle between V_R and V_{eff} is

$$\cos \phi = \frac{V_R}{V_{\text{eff}}} = \frac{V_R}{\sqrt{V_R^2 + (V_L - V_C)^2}}$$

(i) $I = I_0 \sin(\omega t - \phi)$ For $V_L > V_C$ or $X_L > X_C$

(ii) $I = I_0 \sin(\omega t + \phi)$ For $V_L < V_C$ or $X_L < X_C$

Variation of the current I as a function of angular frequency ω .

At resonance, when maximum current flows through the circuit.

$$\begin{aligned} \frac{1}{L_1 C_1} &= \frac{1}{L_2 C_2} \\ L_1 C_1 &= L_2 C_2 \quad \frac{L_1}{L_2} = \frac{C_2}{C_1} \end{aligned}$$

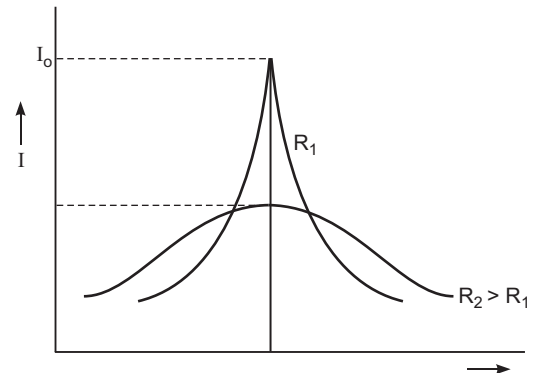
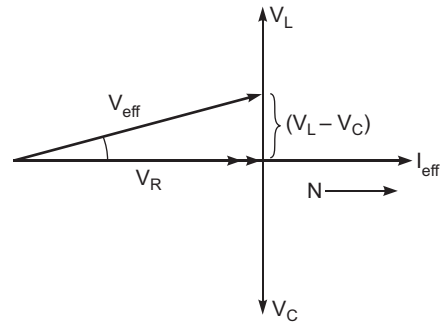

For fine tuning in the receiver set, combination $L_1 C_1$ and R_1 is better because maximum current flows through the circuit.

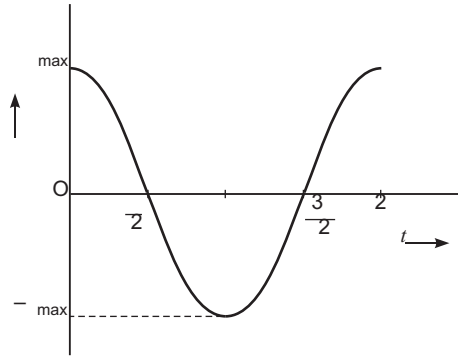

From Lenz's law, induced emf

$$\frac{d}{dt} \int B \cdot dA = \frac{d}{dt} (BA \cos t)$$

$$= -BA \sin t$$

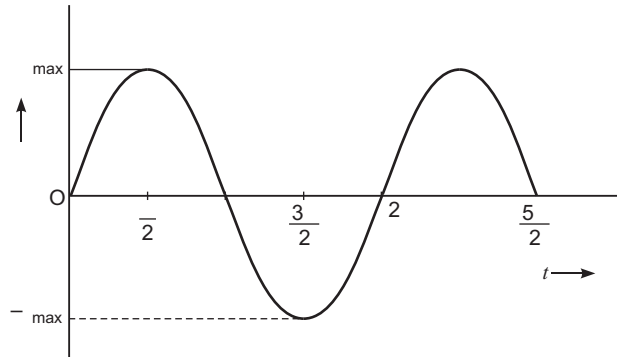

OR

- (a) Mutual inductance of solenoid S_2 with respect to solenoid S_1 , is defined as total magnetic flux linked with solenoid S_2 for unit current flow in solenoid S_1 .

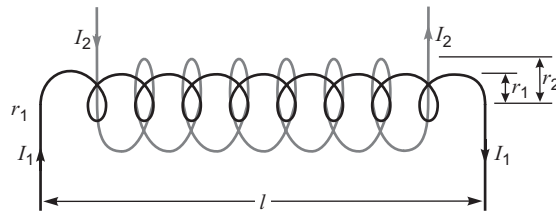

Figure shows two long coaxial solenoids, each of length l , number of turns per unit length n_1 and n_2 wound one over the other. If current I flows through the outer solenoid S_2 , a uniform magnetic field is set up in both solenoids.

$$N_{11} = (n_1 \ell) (\mu_0 n_2 I)$$

$$N_{11} = \mu_0 n_1 n_2 I (\pi r_1^2) \ell$$

If $r_1 = r_2$ or $r_1^2 = A$

$$N_{11} = \mu_0 n_1 n_2 A \ell I$$

Mutual inductance

$$M_{12} = M_{21} = M = \frac{N_{11}}{I}$$

$$M = \mu_0 n_1 n_2 A \ell$$

- (b) The plane of the coil is in yz plane and perpendicular to the x -axis *i.e.*, direction of magnetic field.

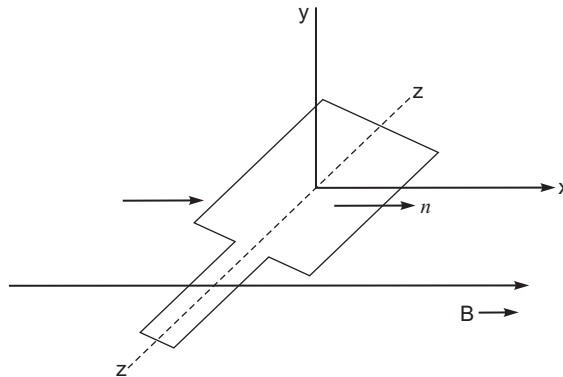

A maximum magnetic flux $\Phi_{\max} = B|A|$.

As the coil rotates with angular speed ω , magnetic flux at any instant t , (or at angle $\theta = \omega t$)
 $\Phi = |B||A| \cos \theta$

28. (a) When plane wavefront coming from distant source illuminate the slit of size $(=d)$, each point within the slit becomes the source of secondary wavelets, and these wavelets superpose on each other to generate the maxima and minima on the screen; path difference between the rays, directing to the point P on the screen can be given as

In $\triangle ABT$

$$\sin \theta = \frac{BT}{AB} = \frac{\text{path difference}}{d}$$

path difference $= d \sin \theta$

Condition of Minima:

If slit AB is divided into the equal halves (or in even parts) each of size $\frac{d}{2}$, for every point in part

AM , there is a point in part MB that contribute the secondary wavelets out of phase (*i.e.*, 180°). So net contribution from two halves becomes zero and hence intensity falls to zero for path difference $= n \lambda$.

$$d \sin \theta = n \lambda$$

$d \sin \theta = n \lambda$ where n is integer except $n = 0$.

Condition of maxima:

If slit AB is divided into three equal parts (or in odd parts). First two thirds of the slit having a path difference $\frac{\lambda}{2}$ between them cancel each other, and only the remaining one third of the set

contributes to the intensity at the point between two minima, so for path difference $= (n + \frac{1}{2}) \lambda$.

We have $d \sin \theta = (n + \frac{1}{2}) \lambda$.

where n is integer except $n = 0$.

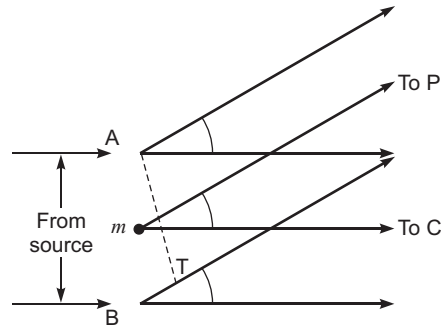

(b) (i) Effect of the width of the slit —

For given monochromatic waves, if slit width is decreased, the fringe pattern becomes broader.

$$d \cdot \frac{y_n}{D} = \left(n - \frac{1}{2}\right) \lambda \quad \left[\frac{y_n}{D} \right]$$

$$d \cdot y_n = \text{constant}$$

$$y_n \propto \frac{1}{d}$$

(ii) If monochromatic source of light is replaced by white light, instead of white fringes we have few coloured fringes on either side of central white fringe, and then uniform illumination on the screen.

$$y_n \propto \lambda \quad (\text{for VIBGYOR})$$

OR

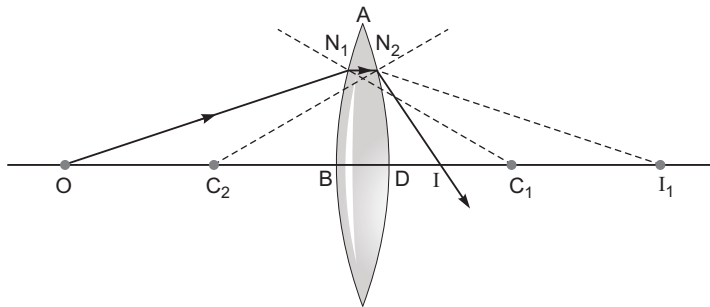

Ray of light ON_1 strikes the convex lens $ABCD$ of radii R_1 and R_2 . First refraction occurs at face ABC and forms the image I_1 of the object O . The image I_1 acts as a virtual object for surface ADC that forms the image I .

On applying the condition of refractions on surfaces ABC and ADC .

$$\frac{1}{OB} - \frac{2}{BI_1} = \frac{2}{BC_1} - \frac{1}{\infty} \quad \dots (1)$$

$$\text{and} \quad \frac{2}{DI_1} - \frac{1}{DI} = \frac{2}{DC_2} - \frac{1}{\infty} \quad \dots (2)$$

For thin lens $BI_1 = DI_1$, and on adding equation (1) and (2).

$$\frac{1}{OB} - \frac{1}{DI} = \frac{2}{BC_1} - \frac{2}{DC_2}$$

Suppose object is at infinity and image at focus then

$$OB = \infty \quad \text{and} \quad DI = f$$

$$\frac{1}{f} - \frac{1}{\infty} = \frac{2}{BC_1} - \frac{2}{DC_2}$$

$$\frac{1}{f} = \frac{2}{BC_1} - \frac{2}{DC_2}$$

On applying sign convention for convex lens $BC_1 = + R_1$ and $DC_2 = - R_2$.

$$\frac{1}{f} = \frac{1}{u} + \frac{1}{v} \quad \therefore \frac{1}{f} = \frac{1}{R_1} + \frac{1}{R_2}$$

29. (a)

S.No.	Intrinsic semiconductor	p-type semiconductor
(i)	It is a semiconductor in pure form.	It is a semiconductor doped with p-type (like Al, In) impurity.
(ii)	Intrinsic charge carriers are electrons and holes with equal concentration.	Majority charge carriers are holes and minority charge carriers are electrons.
(iii)	Current due to charge carriers is feeble (of the order of μA).	Current due to charge carriers is significant (of the order of mA).

p-Type semiconductor is electrically neutral because every atom, whether it is of pure semiconductor (Ge or Si) or of impurity (Al) is electrically neutral.

(b) If p-type and n-type semiconductor are heavily doped. Then due to diffusion of electrons from n-region to p-region, and of holes from p-region to n-region, a depletion region formed of size of order less than $1 \mu m$. The electric field directing from n-region to p-region produces a reverse bias voltage of about 5V and electric field becomes very large.

$$E = \frac{V}{x} = \frac{5V}{1 \mu m} = 5 \times 10^6 V/m$$

Explanation of voltage regulator.

If reverse bias voltage V reaches the breakdown voltage V_Z of zener diode, there is a large change in the current. After that (just above V_Z there is a large change in the current by almost insignificant change in reverse bias voltage. This means diode voltage remains constant.

For example: If unregulated voltage is supplied at terminals A and B, and input voltage increases, the current through resistor R_Z and diode also increases. This current increases the voltage across R_Z without any change in the voltage across diode. Thus, we have a regulated voltage across load resistor R_L .

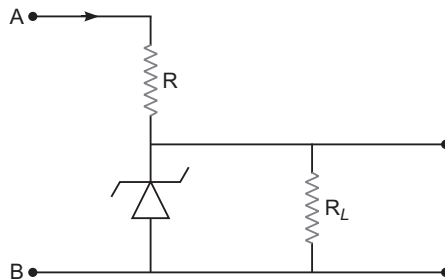

OR

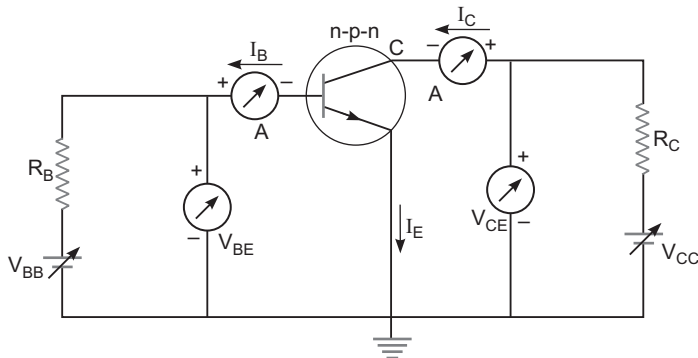

Input characteristics: The variation of the base current I_b with the base-emitter voltage V_{be} at constant V_{ce} .

Input characteristics can be drawn, when the transistor is in active state, so V_{ce} is kept enough large. So base collector junction remain in reverse biased mode *i.e.*, $V_{ce} \gg 0.7$ V.

Output characteristics:

Output characteristic is obtained by measuring the collector current I_C with the variation in V_{ce} keeping base current I_b constant.

Input resistance: It is defined as the ratio of change in base - emitter voltage V_{be} to the resulting change in base current I_b at constant V_{ce} .

$$r_{ac} = \frac{V_{be}}{I_b} \bigg|_{V_{ce}}$$

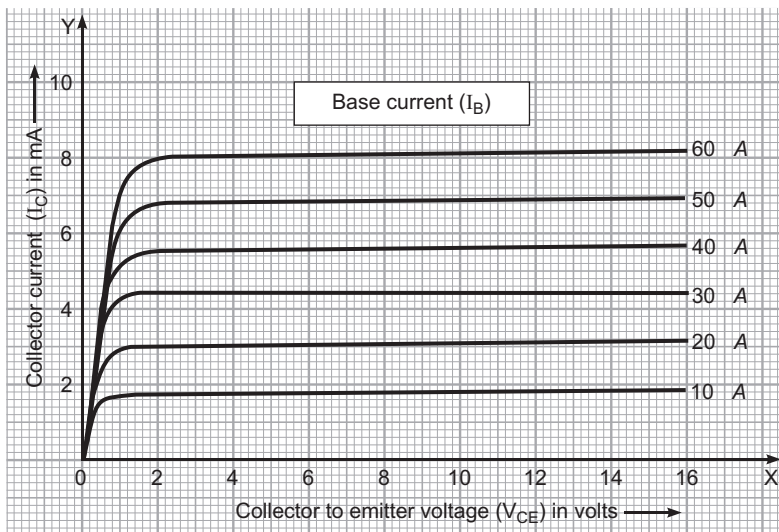
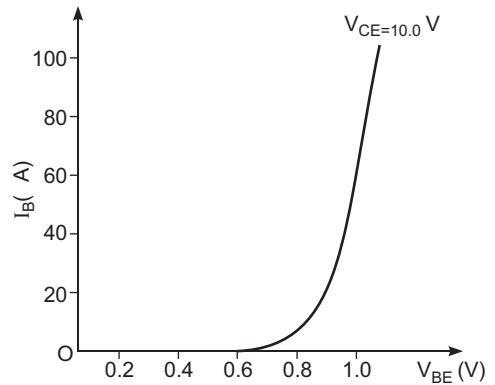

Current Amplification: It is defined as the ratio of change in collector current I_C to the change in base current I_b at a constant V_{ce} , when the transistor is in active state.

$$\beta_{ac} = \frac{I_C}{I_b} \bigg|_{V_{ce}}$$

SET-II

Questions Uncommon to Set-I

1. No (i) This is because the charge particle moves on a circular path.
(ii) $F = q(\vec{v} \times B)$

and power dissipated $P = F v$

$$q v B v q v v B$$

Since $v = 0$

So power $P = 0$ and the particle does not gain any energy.

5. In case of semiconductor Ge, the resistivity increases.

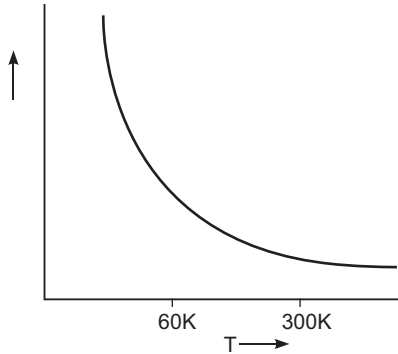

In case of conductor Al, the resistivity decreases.

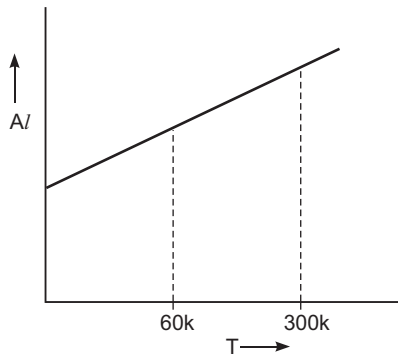

11. Surface charge density = constant.

$$\frac{Q_1}{Q_2} = \frac{4 R^2}{4 (3R)^2} = \frac{1}{9}$$

12. If galvanometer G gives zero deflection, then current of source of 12V flows through R, and voltage across R becomes 2V.

Current in the circuit $I = \frac{12.0V}{R_1 + R_2} = \frac{12.0V}{500 + R}$

and

$$V = IR = 2.0V$$

$$\frac{12.0V}{500 + R} R = 2.0$$

$$12R = 1000 + 2R$$

$$10R = 1000$$

$$R = 100$$

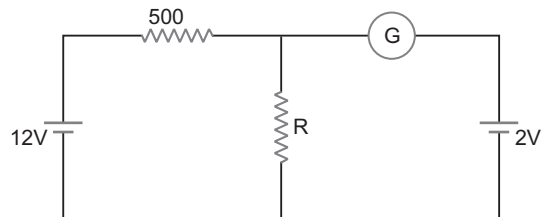
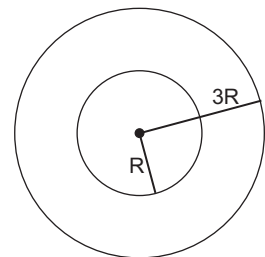

15. Resistance of diode D_1 in forward biasing $R_Z = 50 \Omega$.

Resistance of diode D_2 in reverse biasing =

As no current flows through the diode D_2 , so current from the source flows through diode D_1 .

$$I = \frac{6.0}{R_{net}} = \frac{6.0}{50 + 150 + 100}$$

$$\frac{6.0}{300} = 0.02 \text{ A}$$

$I = 0.02 \text{ A}$ flows through 100Ω resistor.

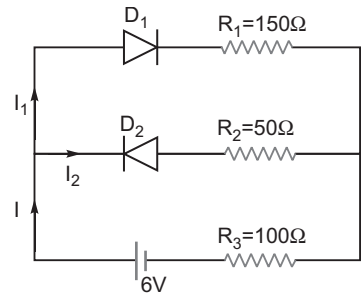

21. Generalised Ampere's circuital Law —

$$\oint dl \cdot \vec{H} = \int_C \vec{J} \cdot d\vec{r} + \frac{d}{dt} \int_S \vec{D} \cdot d\vec{A}$$

Line integral of magnetic field over closed loop is equal to μ_0 times sum of conduction current and displacement current.

(i) In case of steady electric field in a conducting wire, electric field does not change with time, conduction current exists in the wire but displacement current may be zero. So, $\oint dl \cdot \vec{H} = \int_C \vec{J} \cdot d\vec{r}$

(ii) In large region of space, where there is no conduction current, but there is only a displacement current due to time varying electric field (or flux). So, $\oint dl \cdot \vec{H} = \int_C \vec{J}_d \cdot d\vec{r} = \frac{d}{dt} \int_S \vec{D} \cdot d\vec{A}$

22. (a) Labelled diagram of compound microscope.

The objective lens form image $A'B'$ near the first focal point of eyepiece.

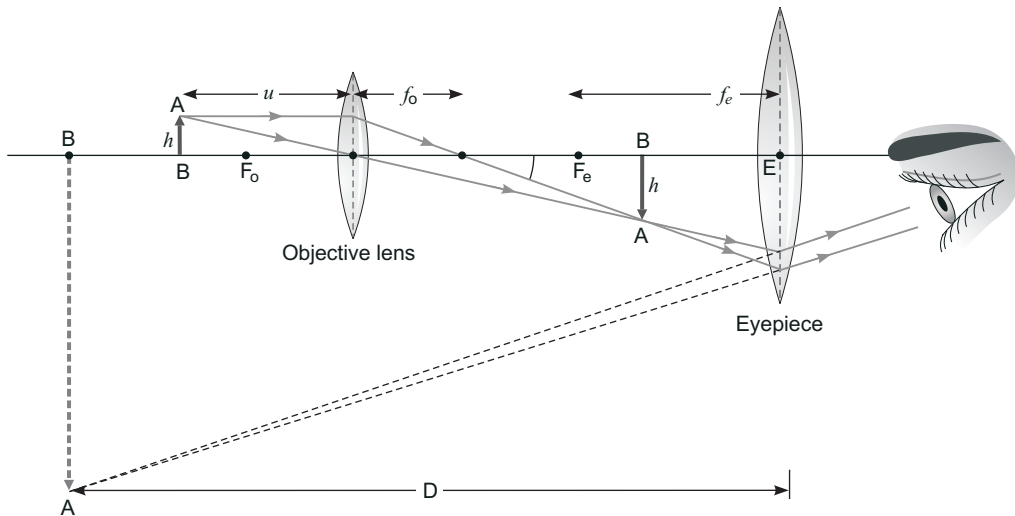

- (b) Angular magnification of objective lens $m_0 = \text{linear magnification} \frac{h'}{h}$

Since $\tan \theta = \frac{h'}{L} = \frac{h}{f_0}$

$$m_0 = \frac{h'}{h} = \frac{L}{f_0} \dots (1)$$

where L is the distance between second focal point of the objective and first focal point of eyepiece.

If the final image $A'B'$ is formed at the near point.

$$\text{Angular magnification } m_e = 1 + \frac{D}{f_e}$$

If the final image $A'B'$ is formed at infinity, then angular magnification $m_e = \frac{D}{f_e} \dots (2)$

Thus, total magnification of the compound microscope

$$\begin{aligned} M &= m_o \times m_e \\ &= \frac{L}{f_o} \times \frac{D}{f_e} \end{aligned}$$

(c) Aperture and focal length increase or decrease the resolving power of the compound microscope.

Resolving power of microscope is given by

$$\text{R.P.} = \frac{2n \sin \alpha}{1.22 \lambda}$$

- (i) On decreasing the aperture (diameter) of the objective lens, value of $\sin \alpha$ decreases, and hence resolving power decreases.
- (ii) On decreasing the focal length of the objective lens, value of $\sin \alpha$ increases and hence resolving power increases.

SET-III

Questions Uncommon to Set-I and Set-II

4. (i) In case of conductor Ag, the resistivity decreases with the fall of temperature from 300 K to 60 K.
(ii) In case of semiconductor (or their alloys GaAs) the resistivity increases with the fall of temperature from 300 K to 60 K.
5. Net force on electron moving in the combined electric field E and magnetic field B is

$$F = e[E + v \times B]$$

Since electron moves undeflected then $F = 0$.

$$\begin{aligned} E + v \times B &= 0 \\ |E| &= |v| |B| \\ |v| &= \frac{|E|}{|B|} \end{aligned}$$

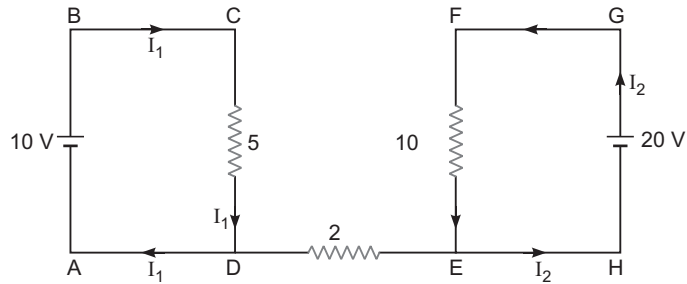
10.

No current will flow through 2 resistor, because in a closed loop, total p.d. must be zero. So

$$10 \text{ V} - 5I_1 = 0 \quad \dots (1)$$

$$20 \text{ V} - 10I_2 = 0 \quad \dots (2)$$

and resistor 2 is not part of any loop ABCD and EFGH.

- 13.** Diode D_1 offers a resistance of 50Ω and D_2 an infinite resistance. It means diode D_1 conducts and diode D_2 does not conduct. So for conducting path through diodes,

$$I = \frac{\text{emf}}{\text{Net resistance}}$$

$$= \frac{6}{\frac{50 + 200 + 100}{6}}$$

$$= 0.0171 \text{ A}$$

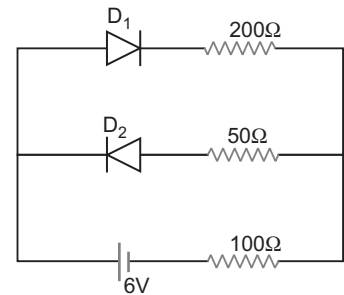

A current of 0.171 A will flow through 100 resistor.

- 18.** (a) Infrared waves are produced by hot bodies and molecules, so are referred to as heat waves.
- Em wave having short wavelength than infrared waves are visible, UV, X-rays and γ -rays.
 - Em wave having longer wavelength than infrared waves are microwaves, short radio waves, television and FM radio.
- (b) Refer to Ans. of 23(b) of Set-I.
- 19.** (a) Refraction type telescope in normal adjustment.

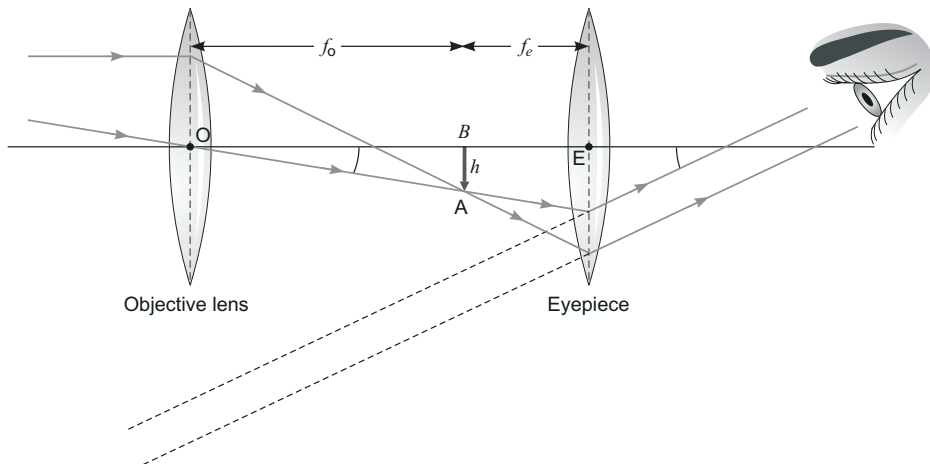

- (b) Shortcomings —
- (i) Very difficult and expensive to make large sized lenses, which can form images that are free from any kind of chromatic aberration and distortions.
 - (ii) By lenses of diameter 1.02 m and above tend to be very heavy and therefore, difficult to make and support by their edges.
- (c) If eyepiece of short focal length and objective lens of large focal length are used in constructing the telescope, magnifying power increases, as per relation $M = \frac{f_0}{f_e}$.

This telescope of high magnifying power can see path of stars of actual separation of one minute arc and even less values of arc.



CBSE Examination Paper Delhi-2014



Time allowed : 3 hours

Maximum marks : 70

General Instructions:

- (i) All questions are compulsory.
- (ii) Question numbers 1 to 8 are very short answer questions and carry 1 mark each.
- (iii) Question numbers 9 to 18 are short answer questions and carry 2 marks each.
- (iv) Question numbers 19 to 27 are also short answer questions and carry 3 marks each.
- (v) Question numbers 28 to 30 are long answer questions and carry 5 marks each.
- (vi) Use log tables, if necessary. Use of calculators is not allowed.

SET-I

1. Define the term 'Mobility' of charge carries in a conductor. Write its SI unit.
2. The carrier wave is given by

$$C(t) = 2 \sin(8\pi t) \text{ volt.}$$

The modulating signal is a square wave as shown. Find modulation index.

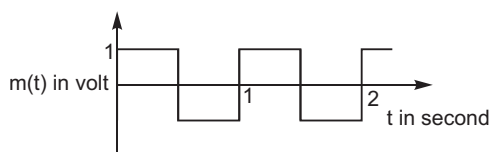

3. "For any charge configuration, equipotential surface through a point is normal to the electric field." Justify.
4. Two spherical bobs, one metallic and the other of glass, of the same size are allowed to fall freely from the same height above the ground. Which of the two would reach earlier and why?
5. Show variation of resistivity of copper as a function of temperature in a graph.
6. A convex lens is placed in contact with a plane mirror. A point object at a distance of 20 cm on the axis of this combination has its image coinciding with itself. What is the focal length of the lens?
7. Write the expression, in a vector form, for the Lorentz magnetic force F due to a charge moving with velocity V in a magnetic field B . What is the direction of the magnetic force?

8. The figure given below shows the block diagram of a generalised communication system. Identify the element labelled 'X' and write its function.

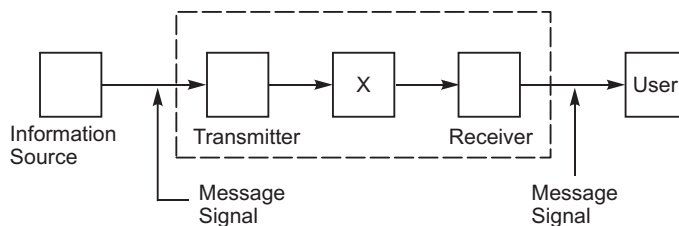

9. Out of the two magnetic materials, 'A' has relative permeability slightly greater than unity while 'B' has less than unity. Identify the nature of the materials 'A' and 'B'. Will their susceptibilities be positive or negative?
10. Given a uniform electric field $E = 5 \times 10^3 \hat{i}$ N/C, find the flux of this field through a square of 10 cm on a side whose plane is parallel to the y - z plane. What would be the flux through the same square if the plane makes a 30° angle with the x -axis?
11. For a single slit of width " a ", the first minimum of the interference pattern of a monochromatic light of wavelength λ occurs at an angle of $\frac{\lambda}{a}$. At the same angle of $\frac{\lambda}{a}$, we get a maximum for two narrow slits separated by a distance " a ". Explain.
12. Write the truth table for the combination of the gates shown. Name the gates used.

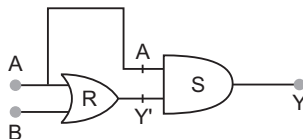

OR

Identify the logic gates marked 'P' and 'Q' in the given circuit. Write the truth table for the combination.

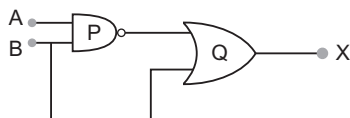

13. State Kirchhoff's rules. Explain briefly how these rules are justified.
14. A capacitor 'C', a variable resistor 'R' and a bulb 'B' are connected in series to the ac mains in circuits as shown. The bulb glows with some brightness. How will the glow of the bulb change if (i) a dielectric slab is introduced between the plates of the capacitor, keeping resistance R to be the same; (ii) the resistor R is increased keeping the same capacitance?

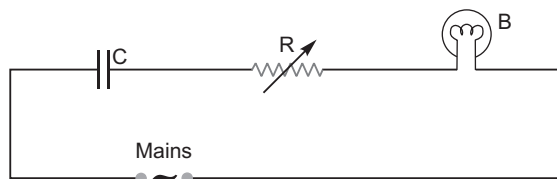

15. State the underlying principle of a cyclotron. Write briefly how this machine is used to accelerate charged particles to high energies.

16. An electric dipole of length 4 cm, when placed with its axis making an angle of 60° with a uniform electric field, experiences a torque of $4\sqrt{3}$ Nm. Calculate the potential energy of the dipole, if it has charge 8 nC .
17. A proton and a deuteron are accelerated through the same accelerating potential. Which one of the two has
(i) greater value of de-Broglie wavelength associated with it, and
(ii) less momentum?
Give reasons to justify your answer.
18. (i) Monochromatic light of frequency 6.0×10^{14} Hz is produced by a laser. The power emitted is 2.0×10^{-3} W. Estimate the number of photons emitted per second on an average by the source.
(ii) Draw a plot showing the variation of photoelectric current versus the intensity of incident radiation on a photosensitive surface.
19. A 12.5 eV electron beam is used to bombard gaseous hydrogen at room temperature. Upto which energy level the hydrogen atoms would be excited?
Calculate the wavelengths of the first member of Lyman and first member of Balmer series.
20. When Sunita, a class XII student, came to know that her parents are planning to rent out the top floor of their house to a mobile company she protested. She tried hard to convince her parents that this move would be a health hazard. Ultimately her parents agreed.
(a) In what way can the setting up of transmission tower by a mobile company in a residential colony prove to be injurious to health?
(b) By objecting to this move of her parents, what value did Sunita display?
(c) Estimate the range of e.m. waves which can be transmitted by an antenna of height 20 m. (Given radius of the earth = 6400 km).
21. A potentiometer wire of length 1 m has a resistance of 10Ω . It is connected to a 6 V battery in series with a resistance of 5Ω . Determine the emf of the primary cell which gives a balance point at 40 cm.
22. (a) Draw a labelled ray diagram showing the formation of a final image by a compound microscope at least distance of distinct vision.
(b) The total magnification produced by a compound microscope is 20. The magnification produced by the eye piece is 5. The microscope is focussed on a certain object. The distance between the objective and eyepiece is observed to be 14 cm. If least distance of distinct vision is 20 cm, calculate the focal length of the objective and the eye piece.
23. (a) A mobile phone lies along the principal axis of a concave mirror. Show, with the help of a suitable diagram, the formation of its image. Explain why magnification is not uniform.
(b) Suppose the lower half of the concave mirror's reflecting surface is covered with an opaque material. What effect this will have on the image of the object? Explain.
24. (a) Obtain the expression for the energy stored per unit volume in a charged parallel plate capacitor.
(b) The electric field inside a parallel plate capacitor is E . Find the amount of work done in moving a charge q over a closed rectangular loop $abcd$.

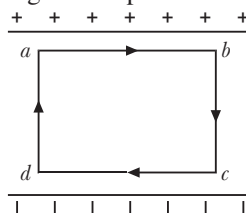

OR

- (a) Derive the expression for the capacitance of a parallel plate capacitor having plate area A and plate separation d .
- (b) Two charged spherical conductors of radii R_1 and R_2 when connected by a conducting wire acquire charges q_1 and q_2 respectively. Find the ratio of their surface charge densities in terms of their radii.
25. (a) State Ampere's circuital law, expressing it in the integral form.
- (b) Two long coaxial insulated solenoids, S_1 and S_2 of equal lengths are wound one over the other as shown in the figure. A steady current " I " flow through the inner solenoid S_1 to the other end B, which is connected to the outer solenoid S_2 through which the same current " I " flows in the opposite direction so as to come out at end A. If n_1 and n_2 are the number of turns per unit length, find the magnitude and direction of the net magnetic field at a point (i) inside on the axis and (ii) outside the combined system.

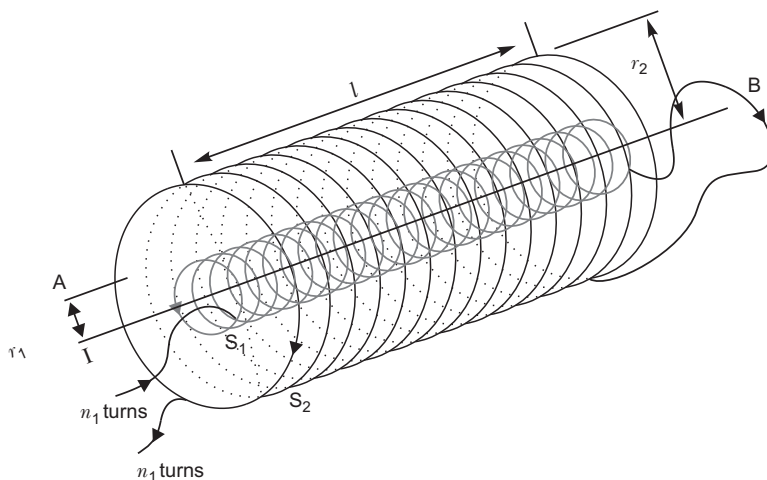

26. Answer the following:
- (a) Name the em waves which are suitable for radar systems used in aircraft navigation. Write the range of frequency of these waves.
- (b) If the earth did not have atmosphere, would its average surface temperature be higher or lower than what it is now? Explain.
- (c) An em wave exerts pressure on the surface on which it is incident. Justify.
27. (a) Deduce the expression, $N = N_0 e^{-\lambda t}$, for the law of radioactive decay.
- (b) (i) Write symbolically the process expressing the decay of ${}_{11}^{22}\text{Na}$. Also write the basic nuclear process underlying this decay.
- (ii) Is the nucleus formed in the decay of the nucleus ${}_{11}^{22}\text{Na}$, an isotope or isobar?
28. (a) (i) 'Two independent monochromatic sources of light cannot produce a sustained interference pattern'. Give reason.
- (ii) Light waves each of amplitude " a " and frequency " ω ", emanating from two coherent light sources superpose at a point. If the displacements due to these waves is given by $y_1 = a \cos(\omega t)$ and $y_2 = a \cos(\omega t + \phi)$ where ϕ is the phase difference between the two, obtain the expression for the resultant intensity at the point.

- (b) In Young's double slit experiment, using monochromatic light of wavelength λ , the intensity of light at a point on the screen where path difference is λ , is K units. Find out the intensity of light at a point where path difference is $\lambda/3$.

OR

- (a) How does one demonstrate, using a suitable diagram, that unpolarised light when passed through a polaroid gets polarised?
- (b) A beam of unpolarised light is incident on a glass-air interface. Show, using a suitable ray diagram, that light reflected from the interface is totally polarised, when $\tan i_B$, where i_B is the refractive index of glass with respect to air and i_B is the Brewster's angle.
- 29.** (a) Describe a simple experiment (or activity) to show that the polarity of emf induced in a coil is always such that it tends to produce a current which opposes the change of magnetic flux that produce it.
- (b) The current flowing through an inductor of self inductance L is continuously increasing. Plot a graph showing the variation of
- (i) Magnetic flux versus the current
 - (ii) Induced emf versus dI/dt
 - (iii) Magnetic potential energy stored versus the current.

OR

- (a) Draw a schematic sketch of an ac generator describing its basic elements. State briefly its working principle. Show a plot of variation of
- (i) Magnetic flux and
 - (ii) Alternating emf versus time generated by a loop of wire rotating in a magnetic field.
- (b) Why is choke coil needed in the use of fluorescent tubes with ac mains?
- 30.** (a) State briefly the processes involved in the formation of $p-n$ junction explaining clearly how the depletion region is formed.
- (b) Using the necessary circuit diagrams, show how the V-I characteristics of a $p-n$ junction are obtained in
- (i) Forward biasing
 - (ii) Reverse biasing
- How are these characteristics made use of in rectification?

OR

- (a) Differentiate between three segments of a transistor on the basis of their size and level of doping.
- (b) How is a transistor biased to be in active state?
- (c) With the help of necessary circuit diagram, describe briefly how $n-p-n$ transistor in CE configuration amplifies a small sinusoidal input voltage. Write the expression for the ac current gain.

SET-II (Questions Uncommon to Set-I)

1. Define the term 'electrical conductivity' of a metallic wire. Write its S.I. unit.
2. The carrier wave is represented by

$$C(t) = 5 \sin(10^8 t) \text{ volt}$$

A modulating signal is a square wave as shown. Determine modulation index.

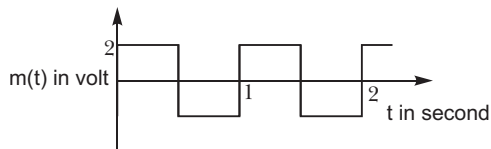

3. Show variation of resistivity of Si with temperature in a graph.
10. An electric dipole of length 2 cm, when placed with its axis making an angle of 60° with a uniform electric field, experiences a torque of $8\sqrt{3} Nm$. Calculate the potential energy of the dipole, if it has a charge of $4 nC$.
15. A proton and an alpha particle are accelerated through the same potential. Which one of the two has (i) greater value of de-Broglie wavelength associated with it and (ii) less kinetic energy? Give reasons to justify your answer.
16. Given a uniform electric field $E = 2 \times 10^3 \hat{i} N/C$, find the flux of this field through a square of side 20 cm, whose plane is parallel to the y - z plane. What would be the flux through the same square, if the plane makes an angle of 30° with the x -axis?
20. A 12.9 eV beam of electrons is used to bombard gaseous hydrogen at room temperature. Upto which energy level the hydrogen atoms would be excited? Calculate the wavelength of the first member of Paschen series and first member of Balmer series.
22. Answer the following:
 - (a) Name the em waves which are used for the treatment of certain forms of cancer. Write their frequency range.
 - (b) Thin ozone layer on top of stratosphere is crucial for human survival. Why?
 - (c) Why is the amount of the momentum transferred by the em waves incident on the surface so small?
24. A potentiometer wire of length 1.0 m has a resistance of 15Ω . It is connected to a 5 V battery in series with a resistance of 5Ω . Determine the emf of the primary cell which gives a balance point at 60 cm.

SET-III (Questions Uncommon to Set-I and II)

1. Define the term 'drift velocity' of charge carriers in a conductor and write its relationship with the current flowing through it.
2. The carrier wave of a signal is given by $C(t) = 3 \sin(8\pi t)$ volt. The modulating signal is a square wave as shown. Find its modulation index.

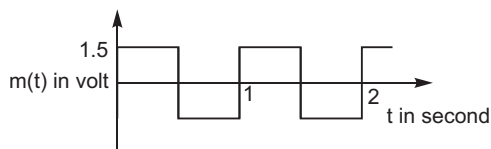

4. Plot a graph showing variation of current versus voltage for the material GaAs.
9. An electric dipole of length 1 cm, which placed with its axis making an angle of 60° with uniform electric field, experiences a torque of $6\sqrt{3} Nm$. Calculate the potential energy of the dipole if it has charge $2 nC$.

12. A deuteron and an alpha particle are accelerated with the same accelerating potential. Which one of the two has
- (a) greater value of de-Broglie wavelength, associated with it and
 - (b) less kinetic energy? Explain.
20. A 12.3 eV electron beam is used to bombard gaseous hydrogen at room temperature. Upto which energy level the hydrogen atoms would be excited?
Calculate the wavelengths of the second member of Lyman series and second member of Balmer series.
24. Answer the following questions:
- (a) Name the em waves which are produced during radioactive decay of a nucleus. Write their frequency range.
 - (b) Welders wear special glass goggles while working. Why? Explain.
 - (c) Why are infrared waves often called as heat waves? Give their one application.
25. A potentiometer wire of length 1 m has a resistance of 5Ω . It is connected to a 8 V battery in series with a resistance of 15Ω . Determine the emf of the primary cell which gives a balance point at 60 cm.



Solutions

SET-I

1. Mobility is defined as the magnitude of the drift velocity per unit electric field.

$$\frac{|v_d|}{E} = \frac{l E}{mE} = \frac{l}{m}$$

where l is the average collision time for electrons.

The SI unit of mobility is m^2/Vs or $\text{m}^2\text{V}^{-1}\text{s}^{-1}$

2. Modulation index
$$\frac{\text{Amplitude of modulated signal}}{\text{Amplitude of carrier waves}}$$

$$\frac{A_m}{A_c} = \frac{1\text{m}}{2\text{m}} = 0.5$$

3. The work done in moving a charge from one point to another on an equipotential surface is zero. If electric field is not normal to the equipotential surface, it would have non-zero component along the surface. In that case work would be done in moving a charge on an equipotential surface.
4. Glass would reach earlier. This is because there is no effect of electromagnetic induction in glass, due to presence of Earth's magnetic field, unlike in the case of metallic ball.
- 5.

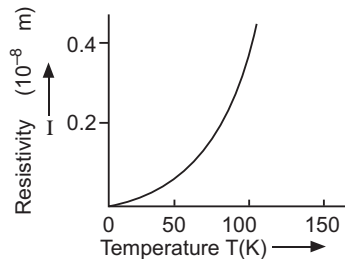

6. The focal length of the lens = 20 cm

Explanation:

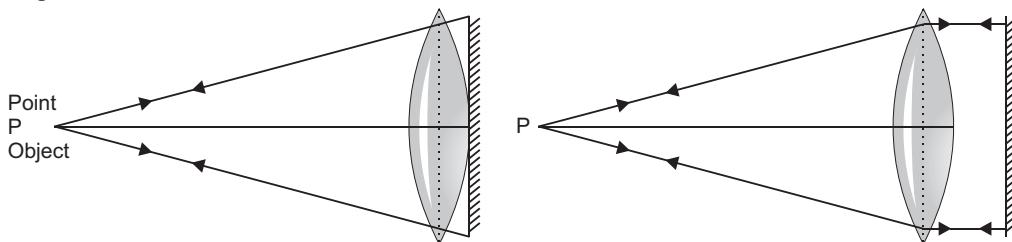

As the image of this combination coincides with the object itself, the rays from the object, after refraction from the lens should fall normally on the plane mirror, so that they retrace their path. So the rays from the point object after refraction from the lens must form parallel beam. For clarity, mirror has been placed at a small distance from the lens.

7. Lorentz force, $F = q(v \times B)$

Obviously, the force on charged particle is perpendicular to both velocity v and magnetic field B .

8. X represents communication channel.

Function: It connects the transmitter to the receiver.

9. A Paramagnetic ($\therefore \mu_r > 1$)

B Diamagnetic ($\therefore \mu_r < 1$)

Susceptibility for A Positive

Susceptibility for B Negative

10. Here, $E = 5 \times 10^3 \hat{i}$ N/C, i.e. field is along positive direction of x-axis.

Surface area, $A = 10 \text{ cm} \times 10 \text{ cm}$

$$= 0.10 \text{ m} \times 0.10 \text{ m} = 10^{-2} \text{ m}^2$$

(i) When plane parallel to y-z plane, the normal to plane is along x axis. Hence

$$\begin{aligned} \Phi &= EA \cos 0 \\ &= 5 \times 10^3 \times 10^{-2} \cos 0 \\ &= 50 \text{ NC}^{-1} \text{ m}^2 \end{aligned}$$

(ii) When the plane makes a 30° angle with the x-axis, the normal to its plane makes 60° angle with x-axis. Hence

$$\begin{aligned} \Phi &= EA \cos 60 \\ &= 5 \times 10^3 \times 10^{-2} \cos 60 \\ &= 25 \text{ NC}^{-1} \text{ m}^2 \end{aligned}$$

11. **Case I:** The overlapping of the contributions of the wavelets from two halves of a single slit produces a minimum because corresponding wavelets from two halves have a path difference of $\lambda/2$.

Case II: The overlapping of the wavefronts from the two slits produces first maximum because these wavefronts have the path difference of λ .

12.

Input		Output
A	B	Y (A OR B)
0	0	0
1	0	1
0	1	1
1	1	1

R : OR gate

S : AND gate

OR

P is NAND gate and Q is OR gate.

Input		Output
A	B	X
0	0	1
1	0	1
0	1	1
1	1	1

13. **Junction rule:** In an electric circuit, the algebraic sum of currents at any junction is zero.

At any junction, the sum of the currents entering the junction is equal to the sum of currents leaving the junction.

$$\sum I = \sum O$$

Justification: This rule is based on the law of conservation of charge.

Loop rule: The algebraic sum of charges in potential around any closed loop involving resistors and cells in the loop is zero.

$$\sum V = 0$$

Justification: This rule is based on the law of conservation of energy.

14. (i) The reactance of the capacitor will decrease, this results in increase of the current in the circuit. So, the bulb will glow brighter.
 (ii) Increased resistance will decrease the current in the circuit, which will decrease glow of the bulb.
15. A cyclotron makes use of the principle that the energy of the charged particles or ions can be made to increase in presence of crossed electric and magnetic fields.

The magnetic field acts on the charged particle and makes them move in a circular path inside the dee. Every time the particle moves from one dee to another it is acted upon by the alternating electric field, and is accelerated by this field, which increases the energy of the particle.

16. Torque, $pE \sin 60^\circ$
 $4\sqrt{3} pE \sin 60^\circ$
 $4\sqrt{3} pE \frac{\sqrt{3}}{2} = 8 pE$

Now, potential energy, $U = pE \cos 60^\circ$
 $= -8 \cos 60^\circ$
 $= -8 \times \frac{1}{2} = -4 \text{ J}$

17. (i) de Broglie wavelength, $\frac{h}{\sqrt{2mqV}}$

Here V is same for proton and deuteron.

As mass of proton < mass of deuteron and $q_p = q_d$

Therefore, $p_p < p_d$ for same accelerating potential.

- (ii) We know that momentum = $\frac{h}{\lambda}$

Therefore, $p_p < p_d$

So, momentum of proton will be less than that of deuteron.

18. (i) Power = nh

where n = number of photons per second

$$2.0 \times 10^{-3} = n \times 6.6 \times 10^{-34} \times 6 \times 10^{14}$$

$$n = \frac{2.0 \times 10^{-3}}{6.6 \times 10^{-34} \times 6 \times 10^{14}}$$

$$\frac{2.0 \times 10^{-3}}{39.6 \times 10^{-20}} \times 0.050 \times 10^{17}$$

$$5 \times 10^{15} \text{ photons per second}$$

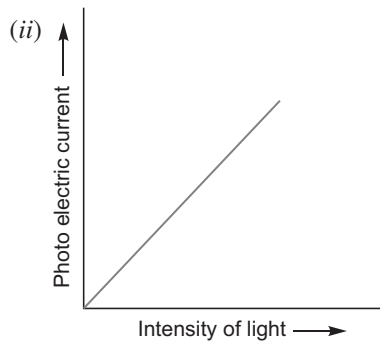

19. Here, $E = 12.5 \text{ eV}$

Energy of an electron in the n th orbit of hydrogen atom is $E_n = \frac{13.6}{n^2} \text{ eV}$

For ground state $n = 1$,

$$E_1 = \frac{13.6}{1^2} \text{ eV} = 13.6 \text{ eV}$$

For first excited state $n = 2$,

$$E_2 = \frac{13.6}{2^2} \text{ eV} = 3.4 \text{ eV}$$

For second excited state $n = 3$,

$$E_3 = \frac{13.6}{3^2} \text{ eV} = -1.51 \text{ eV}$$

Energy required to excite hydrogen atoms from ground state to the second excited state

$$E_{\text{final}} - E_{\text{initial}} = 12.09 \text{ eV}$$

Thus hydrogen atoms would be excited upto third energy level ($n = 3$).

For Lyman series,

$$\frac{1}{\lambda} = R \left(\frac{1}{n_f^2} - \frac{1}{n_i^2} \right)$$

$$\frac{1}{\lambda} = 1.097 \times 10^7 \left(\frac{1}{1^2} - \frac{1}{2^2} \right)$$

$$\frac{1}{\lambda} = 1.097 \times 10^7 \times \frac{3}{4} = 0.82275 \times 10^7 \text{ m}^{-1}$$

$$\lambda = 122 \times 10^9 \text{ m} = 122 \text{ nm}$$

For Balmer series

$$\frac{1}{\lambda} = 1.097 \times 10^7 \left(\frac{1}{2^2} - \frac{1}{3^2} \right)$$

$$\frac{1}{\lambda} = \frac{1.097 \times 10^7}{36} - \frac{1}{0.15236 \times 10^7} = 6.563 \times 10^{-7} \text{ m}^{-1}$$

$$\lambda = 656.3 \text{ nm}$$

20. (a) Electromagnetic radiations emitted by an antenna can cause cancer, cardiac problem and headache.

(b) Sunita displayed awareness and scientific temperament.

(c) Range = $\sqrt{2hR}$

$$= \sqrt{2 \times 20 \times 6400 \times 1000}$$

$$= \sqrt{4 \times 64 \times 10^6} = 16000 \text{ m}$$

21. Here, $l = 1 \text{ m}$, $R_1 = 10 \Omega$, $V = 6 \text{ V}$, $R_2 = 5 \Omega$

Current flowing in potentiometer wire,

$$I = \frac{V}{R_1 + R_2} = \frac{6}{10 + 5} = \frac{6}{15} = 0.4 \text{ A}$$

Potential drop across the potentiometer wire

$$V = IR = 0.4 \times 10 = 4 \text{ V}$$

Potential gradient, $K = \frac{V}{l} = \frac{4}{1} = 4 \text{ V/m}$

Emf of the primary cell = Kl

$$= 4 \times 0.4 = 1.6 \text{ V}$$

22. (a)

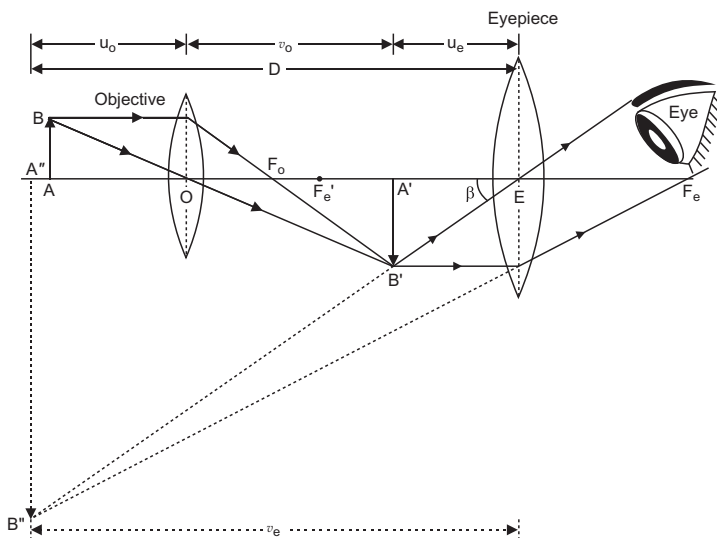

(b) Here, $m = 20$, $m_e = 5$, $v_e = 20 \text{ cm}$

For eyepiece, $m_e = \frac{v_e}{u_e}$

$$5 = \frac{20}{u_e} \Rightarrow u_e = \frac{20}{5} = 4 \text{ cm}$$

Using lens formula,

$$\frac{1}{v_e} - \frac{1}{u_e} = \frac{1}{f_e}$$

$$\frac{1}{20} - \frac{1}{4} = \frac{1}{f_e}$$

$$\frac{1}{20} - \frac{5}{20} = \frac{1}{f_e} \quad f_e = 5 \text{ cm}$$

Now, total magnification

$$m = m_e \cdot m_0$$

$$= \frac{20}{5} \cdot \frac{m_0}{4}$$

Also $|v_0| = |u_e| = 14$
 $|v_0| = |4| = 14$
 $v_0 = 14 = 4 + 10 \text{ cm}$

$$m_0 = 1 + \frac{v_0}{f_0}$$

$$= 4 = 1 + \frac{10}{f_0}$$

$$5 = \frac{10}{f_0} \quad f_0 = 2 \text{ cm.}$$

23. (a)

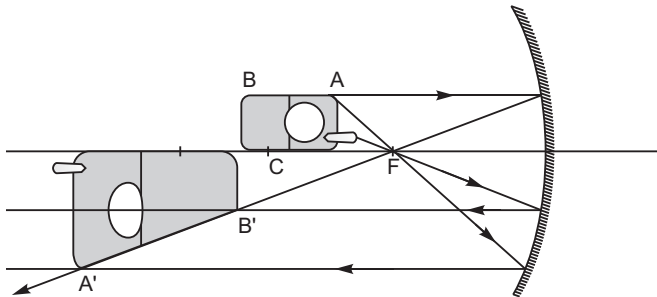

The position of the image of different parts of the mobile phone depends on their position with respect to the mirror. The image of the part which is on the plane perpendicular to principal axis will be on the same plane. It will be of the same size, i.e., $BC = B'C'$. The images of the other parts of the phone are getting magnified in accordance with their object distance from the mirror.

- (b) Taking the laws of reflection to be true for all points of the remaining (uncovered) part of the mirror, the image will be that of the whole object. As the area of the reflecting surface has been reduced, the intensity of the image will be low (in this case half).

24. (a) When a capacitor is charged by a battery, work is done by the charging battery at the expense of its chemical energy. This work is stored in the capacitor in the form of electrostatic potential energy.

Consider a capacitor of capacitance C . Initial charge on capacitor is zero. Initial potential difference between capacitor plates zero. Let a charge Q be given to it in small steps. When

charge is given to capacitor, the potential difference between its plates increases. Let at any instant when charge on capacitor be q , the potential difference between its plates $V = \frac{q}{C}$.

Now work done in giving an additional infinitesimal charge dq to capacitor

$$dW = V dq = \frac{q}{C} dq$$

The total work done in giving charge from 0 to Q will be equal to the sum of all such infinitesimal works, which may be obtained by integration. Therefore total work

$$W = \int_0^Q V dq = \int_0^Q \frac{q}{C} dq$$

$$= \frac{1}{C} \left[\frac{q^2}{2} \right]_0^Q = \frac{1}{C} \left[\frac{Q^2}{2} - \frac{0}{2} \right] = \frac{Q^2}{2C}$$

If V is the final potential difference between capacitor plates, then $Q = CV$

$$W = \frac{(CV)^2}{2C} = \frac{1}{2} CV^2 = \frac{1}{2} QV$$

This work is stored as electrostatic potential energy of capacitor *i.e.*,

$$\text{Electrostatic potential energy, } U = \frac{Q^2}{2C} = \frac{1}{2} CV^2 = \frac{1}{2} QV$$

Energy density: Consider a parallel plate capacitor consisting of plates, each of area A , separated by a distance d . If space between the plates is filled with a medium of dielectric constant K , then

$$\text{Capacitance of capacitor, } C = \frac{K \epsilon_0 A}{d}$$

If σ is the surface charge density of plates, then electric field strength between the plates

$$E = \frac{\sigma}{K \epsilon_0} = \frac{K \epsilon_0 E}{K \epsilon_0}$$

$$\text{Charge on each plate of capacitor } Q = A K \epsilon_0 E$$

$$\text{Energy stored by capacitor, } U = \frac{Q^2}{2C} = \frac{(K \epsilon_0 EA)^2}{2(K \epsilon_0 A/d)} = \frac{1}{2} K \epsilon_0 E^2 A d$$

But Ad = volume of space between capacitor plates

$$\text{Energy stored, } U = \frac{1}{2} K \epsilon_0 E^2 Ad$$

$$\text{Electrostatic Energy stored per unit volume, } u_e = \frac{U}{Ad} = \frac{1}{2} K \epsilon_0 E^2$$

This is expression for electrostatic energy density in medium of dielectric constant K .

$$\text{In air or free space } (K = 1), \text{ therefore energy density, } u_e = \frac{1}{2} \epsilon_0 E^2$$

(b) Work done in moving a charge q from a to $b = 0$

Work done in moving a charge q from c to $d = 0$

This is because the electric field is perpendicular to the displacement.

Now, work done from b to $c = -$ work done from d to a

Therefore, total work done in moving a charge q over a closed loop = 0.

OR

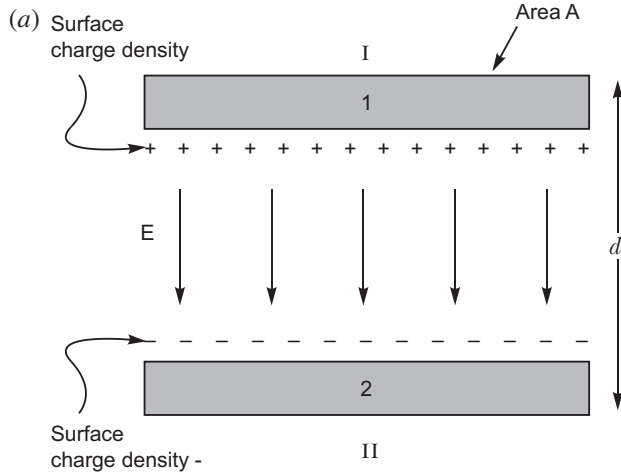

In the region between the plates the net electric field is equal to the sum of the electric fields due to the two charged plates. Thus, the net electric field is given by

$$E = \frac{Q}{2\epsilon_0 A} + \frac{Q}{2\epsilon_0 A} = \frac{Q}{\epsilon_0 A}$$

The electric field is constant in the region between the plates. Therefore, the potential difference between the plates will be

$$V = Ed = \frac{Qd}{\epsilon_0 A}$$

Now, capacitance

$$C = \frac{Q}{V} = \frac{Q\epsilon_0 A}{Qd} = \frac{\epsilon_0 A}{d}$$

Surface charge density $\frac{Q}{A}$, where A is the area of cross-section of the plates.

$$C = \frac{Q\epsilon_0 A}{Qd} = \frac{\epsilon_0 A}{d}$$

(b) When two charged spherical conductors are connected by a conducting wire, they acquire the same potential.

$$\frac{kq_1}{R_1} = \frac{kq_2}{R_2}$$

Or $\frac{q_1}{R_1} = \frac{q_2}{R_2} \Rightarrow \frac{q_1}{q_2} = \frac{R_1}{R_2}$

Hence, the ratio of surface charge densities

$$\frac{1}{2} = \frac{q_1 / 4\pi R_1^2}{q_2 / 4\pi R_2^2} = \frac{q_1 R_2^2}{q_2 R_1^2}$$

$$\frac{R_1}{R_2} = \frac{R_2^2}{R_1^2} \Rightarrow \frac{R_2}{R_1}$$

25. (a) The line integral of magnetic field (B) around any closed path in vacuum is μ_0 times the net current (I) threading the area enclosed by the curve.

$$\oint \vec{B} \cdot d\vec{l} = \mu_0 I$$

- (b) Magnetic field, $B = \mu_0 nI$

- (i) Magnitude of net magnetic field inside the combined system on the axis,

$$\begin{aligned} B &= B_1 - B_2 \\ &= \mu_0 n_1 I - \mu_0 n_2 I \\ &= \mu_0 (n_1 - n_2) I \end{aligned}$$

- (ii) Outside the combined system, net magnetic field is zero.

26. (a) Microwaves

Frequency range : 10^{10} Hz to 10^{12} Hz

- (b) Average surface temperature will be lower. This is because there will be no green house effect in absence of atmosphere.

- (c) An electromagnetic wave exerts pressure on the surface on which it is incident because these waves carry both energy and momentum.

27. (a) **Radioactive decay Law:** The rate of decay of radioactive nuclei is directly proportional to the number of undecayed nuclei at that time.

Derivation of Formula

Suppose initially the number of atoms in radioactive element is N_0 and N the number of atoms after time t .

After time t , let dN be the number of atoms which disintegrate in a short interval dt , then rate of disintegration will be $\frac{dN}{dt}$, this is also called the activity of the substance/element.

According to Rutherford-Soddy law

$$\frac{dN}{dt} = -\lambda N$$

$$\text{or } \frac{dN}{N} = -\lambda dt \quad \dots(i)$$

where λ is a constant, called decay constant or disintegration constant of the element. Its unit is s^{-1} . Negative sign shows that the rate of disintegration decreases with increase of time. For a given element/substance λ is a constant and is different for different elements. Equation (i) may be rewritten as

$$\frac{dN}{N} = -\lambda dt$$

$$\text{Integrating } \log_e N = -\lambda t + C \quad \dots(ii)$$

where C is a constant of integration.

At $t = 0$, $N = N_0$

$$\log_e N_0 = 0 + C \quad C = \log_e N_0$$

$$\text{Equation (ii) gives } \log_e N = -\lambda t + \log_e N_0$$

$$\text{or } \log_e N - \log_e N_0 = -\lambda t$$

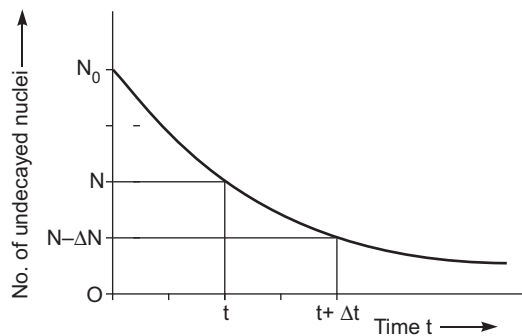

or $\log_e \frac{N}{N_0} = -\lambda t$

or $\frac{N}{N_0} = e^{-\lambda t}$

$N = N_0 e^{-\lambda t}$... (iii)

According to this equation, the number of undecayed atoms/nuclei of a given radioactive element decreases exponentially with time (*i. e.*, more rapidly at first and slowly afterwards).

Mark of $N = \frac{N_0}{16}$ in terms of $T_{1/2}$ is shown in fig.

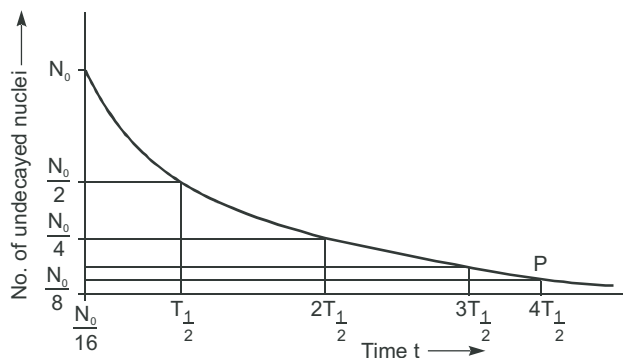

Basic nuclear process:



(ii) Isobar

28. (a) (i) The light waves, originating from two independent monochromatic sources, will not have a constant phase difference. Therefore, these sources will not be coherent and therefore would not produce a sustained interference pattern.

(ii) The resultant displacement will be given by

$$y = y_1 + y_2 = a \cos(\omega t) + a \cos(\omega t + \phi) = 2a \cos\left(\frac{\phi}{2}\right) \cos\left(\omega t + \frac{\phi}{2}\right)$$

$$2a \cos\left(\frac{\phi}{2}\right) \cos\left(\omega t - \frac{\phi}{2}\right)$$

The amplitude of the resultant displacement is $2a \cos\left(\frac{\phi}{2}\right)$

The intensity of light is directly proportional to the square of amplitude of the wave. The resultant intensity will be given by

$$I = 4a^2 \cos^2 \frac{\phi}{2}$$

(b) A path difference of $\frac{\lambda}{2}$, corresponds to a phase difference of π

$$\text{Intensity, } I = 4a^2 \cos^2 \frac{\pi}{2} = 0 \quad \text{or} \quad a^2 \cos^2 \frac{\pi}{4} = \frac{I}{4}$$

A path difference of $\frac{\lambda}{3}$, corresponds to a phase difference of $\frac{2\pi}{3}$

$$\text{Intensity} = 4 \cdot \frac{I}{4} \cdot \cos^2 \frac{2\pi}{3} = \frac{I}{4}$$

OR

(a) A polaroid consists of long chain molecules aligned in a particular direction. The electric vectors along the direction of the aligned molecules get absorbed. So, when an unpolarised light falls on a polaroid, it lets only those of its electric vectors that are oscillating along a direction perpendicular to its aligned molecules to pass through it. The incident light thus gets linearly polarised.

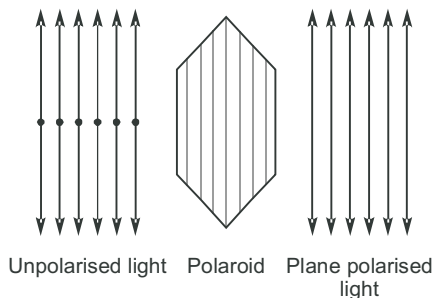

Whenever unpolarised light is incident on the boundary between two transparent media, the reflected light gets partially or completely polarised. When reflected light is perpendicular to the refracted light, the reflected light is a completely polarised light.

(b) Condition : The reflected ray is totally plane polarised, when reflected and refracted rays are perpendicular to each other.

$$\angle BOC = 90^\circ$$

If i_p is angle of incidence, r is angle of reflection and r the angle of refraction, then according to law of reflection

$$i_p = r$$

and from fig. $r + 90^\circ + r = 180^\circ$

$$i_p = r = 90^\circ \quad \dots(i)$$

$$r = (90^\circ - i_p) \quad \dots(ii)$$

From Snell's law, refractive index of second medium relative to first medium (air) say,

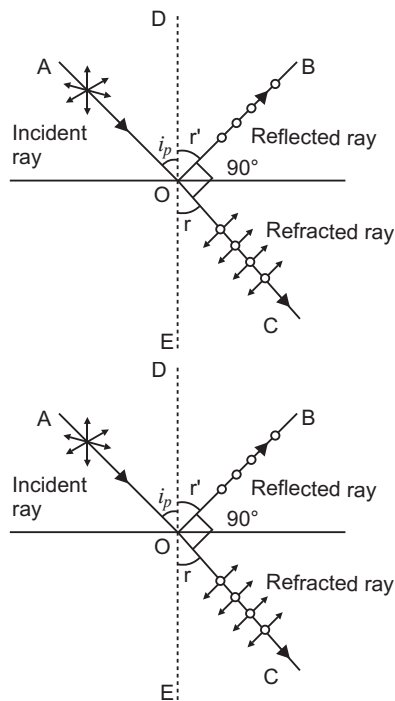

$$n \frac{\sin i_p}{\sin r} = \frac{\sin i_p}{\sin (90^\circ - i_p)} = \frac{\sin i_p}{\cos i_p}$$

$$n = \tan i_p$$

$$\text{Angle of incidence, } i_p = \tan^{-1}(n).$$

29. (a) When the North pole of a bar magnet moves towards the closed coil, the magnetic flux through the coil increases. This produces an induced emf which produces (or tend to produce if the coil is open) an induced current in the anti-clockwise sense. The anti-clockwise sense corresponds to the generation of North pole which opposes the motion of the approaching N pole of the magnet. The face of the coil, facing the approaching magnet, then has the same polarity as that of the approaching pole of the magnet. The induced current, therefore, is seen to oppose the change of magnetic flux that produces it.

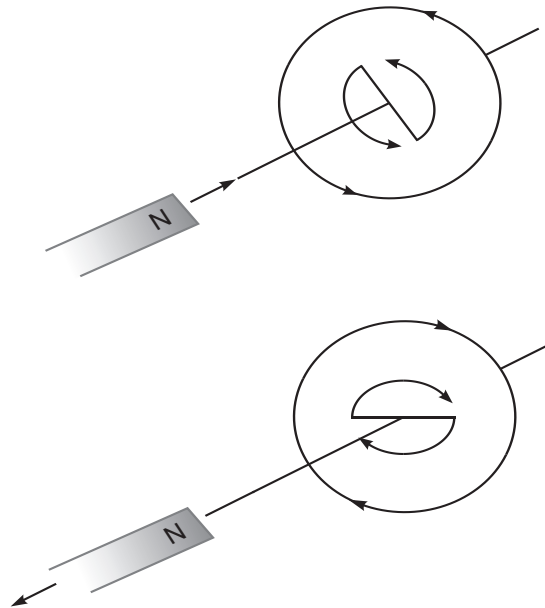

When a North pole of a magnet is moved away from the coil, the current (I) flows in the clock-wise sense which corresponds to the generation of South pole. The induced South pole opposes the motion of the receding North pole.

- (b) (i) Magnetic flux versus the current

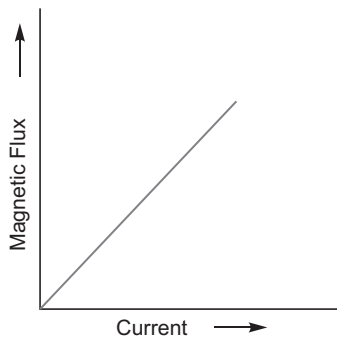

(ii) Induced emf versus dI/dt

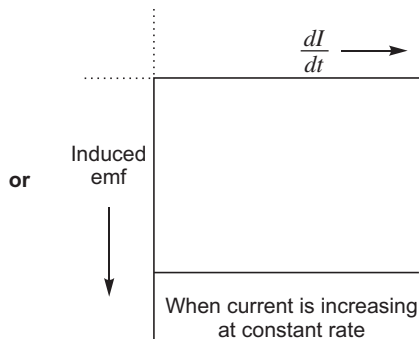
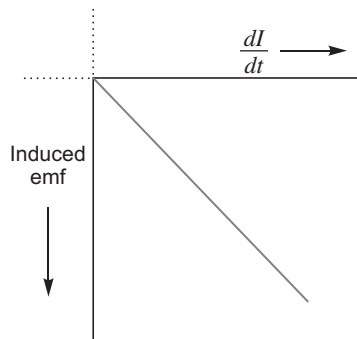

(iii) Magnetic energy stored

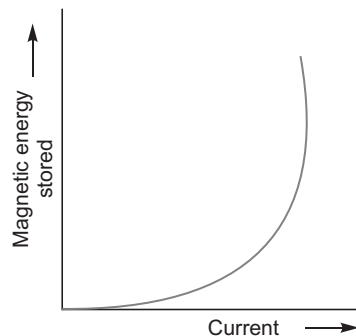

OR

(a) Working: When the armature coil is rotated in the strong magnetic field, the magnetic flux linked with the coil changes and the current is induced in the coil, its direction being given by Fleming's right hand rule. Considering the armature to be in vertical position and as it rotates in anticlockwise direction, the wire ab moves upward and cd downward, so that the direction of induced current is shown in fig. In the external circuit, the current flows along $B_1R_LB_2$. The direction of current remains unchanged during the first half turn of armature. During the second half revolution, the wire ab moves downward and cd upward, so the direction of current is reversed and in external circuit it flows along $B_2R_LB_1$. Thus the direction of induced emf and current changes in the external circuit after each half revolution.

Expression for Induced emf: If N is the number of turns in coil, f the frequency of rotation, A area of coil and B the magnetic induction, then induced emf

$$e = \frac{d}{dt} \frac{d}{dt} \{NBA (\cos 2\pi f t)\}$$

$$= 2\pi NBA f \sin 2\pi f t$$

Obviously, the emf produced is alternating and hence the current is also alternating.

Current produced by an ac generator cannot be measured by moving coil ammeter; because the average value of ac over full cycle is zero.

The source of energy generation is the mechanical energy of rotation of armature coil.

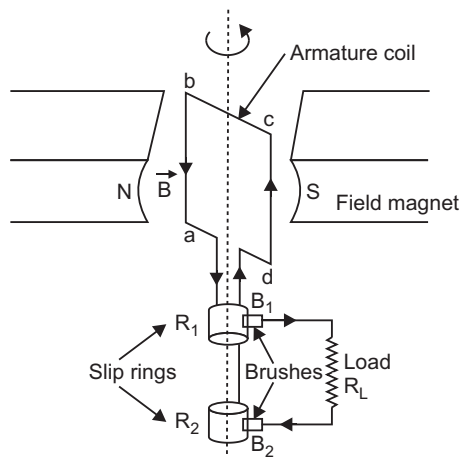

(i) Plot of variation of magnetic flux with time.

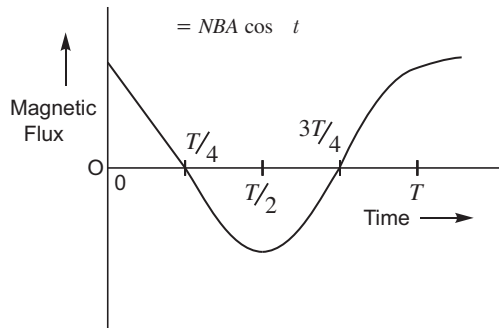

(ii) Plot of variation of alternating emf with time.

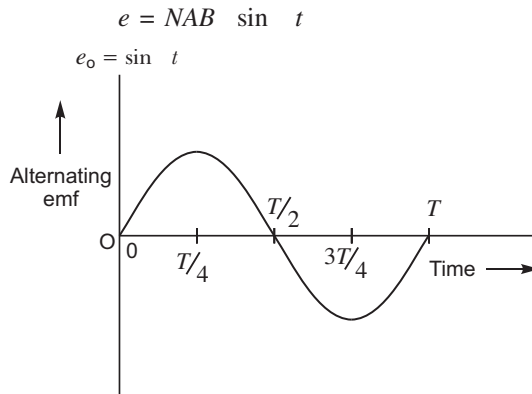

(b) Choke coil reduces the voltage across the fluorescent tube without wastage of power.

30. (a)

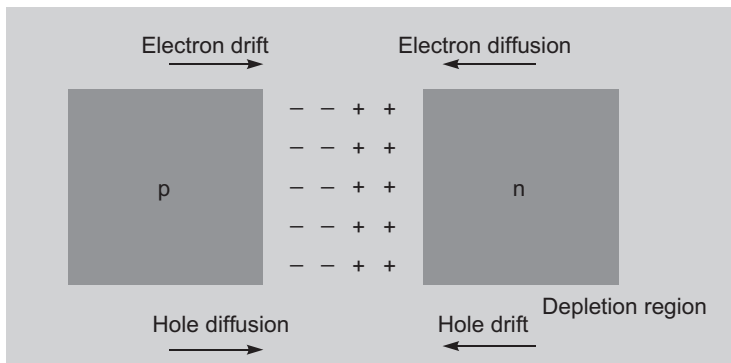

Two processes occur during the formation of a p - n junction are diffusion and drift. Due to the concentration gradient across p and n -sides of the junction, holes diffuse from p -side to n -side ($p \rightarrow n$) and electrons diffuse from n -side to p -side ($n \rightarrow p$). This movement of charge carriers leaves behind ionised acceptors (negative charge - immobile) on the p -side and donors (positive charge + immobile) on the n -side of the junction. This space charge region on either side of the junction together is known as depletion region.

(b) The circuit arrangement for studying the V - I characteristics of a diode are shown in Fig. (a) and (b). For different values of voltages the value of current is noted. A graph between V and I is obtained as in Figure (c).

From the V-I characteristic of a junction diode it is clear that it allows current to pass only when it is forward biased. So if an alternating voltage is applied across a diode the current flows only in that part of the cycle when the diode is forward biased. This property is used to rectify alternating voltages.

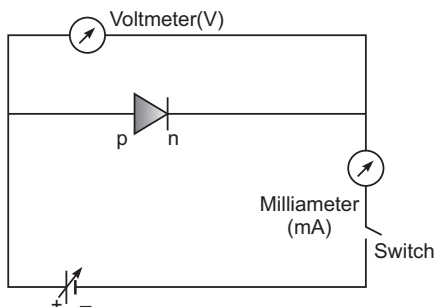

(a)

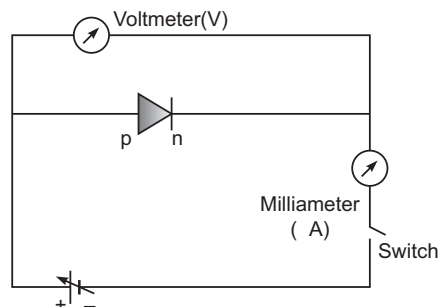

(b)

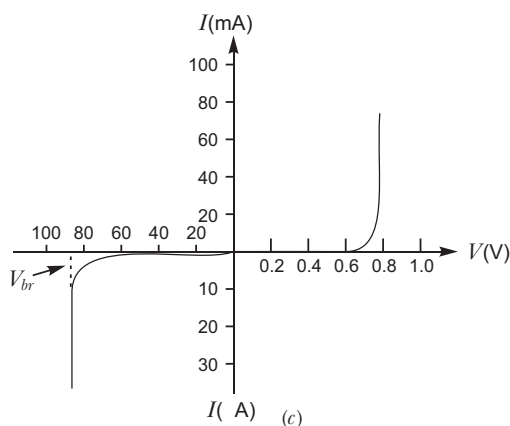

(c)

OR

(a) Emitter: It is of moderate size and heavily doped.

Base: It is very thin and lightly doped.

Collector: The collector side is moderately doped and larger in size as compared to the emitter.

(b) Transistor is said to be in active state when its emitter-base junction is suitably forward biased and base-collector junction is suitably reverse biased.

(c)

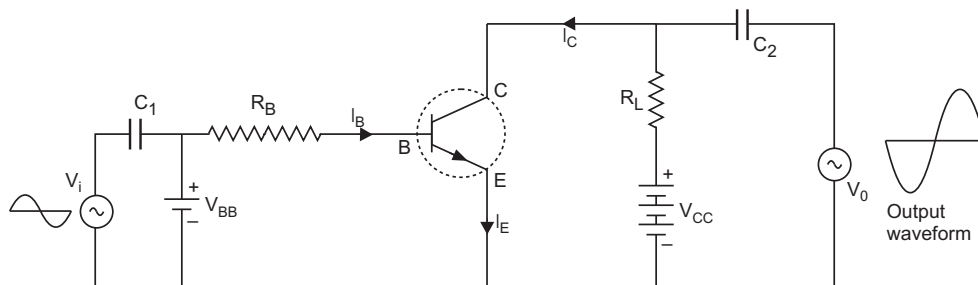

If a small sinusoidal voltage with amplitude v_s is superposed on the dc base bias by connecting the source of that signal in series with the V_{BB} supply, then the base current will have

sinusoidal variations superimposed on the value of I_B . As a consequence the collector current also will have sinusoidal variations superimposed on the value of I_C producing in turn corresponding change in the value of V_0 .

$$\text{AC current gain } B_{ac} = \frac{I_C}{I_B} \cdot \frac{V_{CE}}{V_0}$$

SET-II (Questions Uncommon to Set-I)

1. The reciprocal of the resistivity of a material is called its conductivity and is denoted by σ .

$$\text{Conductivity} = \frac{1}{\text{Resistivity}}$$

The SI unit of conductivity is $\text{ohm}^{-1} \text{m}^{-1}$ or S m^{-1} .

2. Modulation index $\frac{A_m}{A_c} = \frac{2}{5} = 0.4$

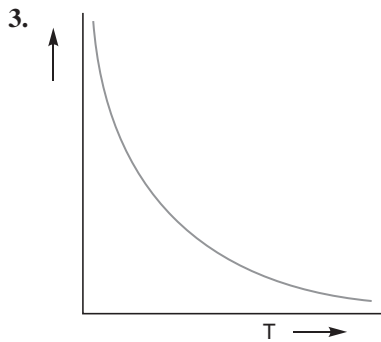

Resistivity of Si decreases with increasing temperatures.

10. Torque, $\frac{pE \sin 60}{8\sqrt{3}}$

$$= \frac{pE \frac{\sqrt{3}}{2}}{8\sqrt{3}}$$

$$= \frac{pE}{16}$$

Potential energy, $u = \frac{pE \cos 60}{16}$

$$= \frac{16 \cdot \frac{1}{2}}{16} = 8 \text{ J}$$

15. (i) de Broglie wavelength

$$\frac{h}{p} = \frac{h}{\sqrt{2mqV}}$$

For same V ,

$$\frac{1}{\sqrt{mq}}$$

$$\frac{p}{\sqrt{\frac{m}{m_p} \frac{q}{q_p}}} = \sqrt{\frac{4m_p}{m_p} \cdot \frac{2e}{e}} = \sqrt{8} = 2\sqrt{2}$$

Clearly, $\lambda_p > \lambda_e$.

Hence, proton has a greater de-Broglie wavelength.

(ii) Kinetic energy, $K = qV$

For same V , $K \propto q$

$$\frac{K_p}{K_e} = \frac{q_p}{q_e} = \frac{e}{2e} = \frac{1}{2}$$

Clearly, $K_p < K_e$.

Hence, proton has less kinetic energy.

16. Here, $E = 2 \times 10^3 \hat{i}$ N/C

i.e., field is along positive direction of x -axis.

Surface area, $A = 20 \text{ cm} \times 20 \text{ cm}$

$$= 0.20 \text{ m} \times 0.20 \text{ m} = 4 \times 10^{-2} \text{ m}^2$$

(i) When plane parallel to $y-z$ plane, the normal to plane is along x -axis. Hence $\theta = 0^\circ$.

$$\begin{aligned} \Phi &= EA \cos \theta \\ &= 2 \times 10^3 \times 4 \times 10^{-2} \cos 0^\circ = 80 \text{ NC}^{-1} \text{ m}^2 \end{aligned}$$

(ii) When the plane makes a 30° angle with the x -axis, the normal to its plane makes 60° angle with x -axis.

Hence, $\theta = 60^\circ$

$$\begin{aligned} \Phi &= EA \cos \theta \\ &= 2 \times 10^3 \times 4 \times 10^{-2} \cos 60^\circ = 40 \text{ NC}^{-1} \text{ m}^2. \end{aligned}$$

20. Energy of an electron, $E_n = \frac{13.6}{n^2} \text{ eV}$

$$\text{For } n = 1, E_1 = \frac{13.6}{1^2} = 13.6 \text{ eV}$$

$$\text{For } n = 2, E_2 = \frac{13.6}{2^2} = 3.4 \text{ eV}$$

$$\text{For } n = 3, E_3 = \frac{13.6}{3^2} = 1.51 \text{ eV}$$

$$\text{For } n = 4, E_4 = \frac{13.6}{4^2} = 0.85 \text{ eV}$$

Energy required to excite hydrogen atoms from ground state to excited state $E_f - E_i$
 $0.85 - (-13.6) = 12.75 \text{ eV}$

Thus, hydrogen atom would be excited upto level $n = 4$.

For Paschen series

$$\frac{1}{\lambda} = R \left[\frac{1}{n_f^2} - \frac{1}{n_i^2} \right]$$

$$\frac{1}{\lambda} = 1.097 \times 10^7 \left[\frac{1}{3^2} - \frac{1}{4^2} \right]$$

$$\frac{1}{\lambda} = 1.097 \times 10^7 \left[\frac{1}{9} - \frac{1}{16} \right]$$

$$\frac{1}{\lambda} = 1.097 \times 10^7 \left(\frac{7}{144} - \frac{1}{144} \right)$$

$$\frac{1}{\lambda} = \frac{144}{7.679 \times 10^7} \quad 18.75 \times 10^7 \text{ m} = 1875 \text{ nm}$$

For Balmer Series

$$\frac{1}{\lambda} = R \left(\frac{1}{2^2} - \frac{1}{3^2} \right)$$

$$\frac{1}{\lambda} = 1.097 \times 10^7 \left(\frac{1}{4} - \frac{1}{9} \right)$$

$$\frac{1}{\lambda} = 1.097 \times 10^7 \left(\frac{5}{36} \right)$$

$$\frac{1}{\lambda} = \frac{36}{5.485 \times 10^7} \quad 6.56 \times 10^7 \text{ m} = 656 \text{ nm}$$

22. (a) X rays or rays

Range: 10^{18} Hz to 10^{22} Hz.

- (b) Ozone layer absorbs the ultraviolet radiations from the sun and prevents it from reaching the earth's surface.

- (c) Momentum transferred,

$$p = \frac{u}{c}$$

where u = energy transferred

c = speed of light

Due to the large value of speed of light (c), the amount of momentum transferred by the em waves incident on the surface is small.

24. Current $I = \frac{V}{R_1 + R_2}$

$$I = \frac{5}{15 + 5} = 0.25 \text{ A}$$

Potential drop across the potentiometer wire

$$V = IR = 0.25 \times 15 = 3.75 \text{ V}$$

Potential gradient,

$$k = \frac{V}{l} = \frac{3.75}{1.0} = 3.75 \text{ V/m}$$

Unknown emf of the cell = KI

$$= 3.75 \times 0.6 = 2.25 \text{ V.}$$

SET-III (Questions Uncommon to Set-I and II)

1. Drift velocity is defined as the average velocity acquired by the free electrons in a conductor under the influence of an electric field applied across the conductor. It is denoted by v_d .

Current, $I = neAv_d$

2. Modulation index $\frac{A_m}{A_c}$
 $\frac{1.5}{3.0} = 0.5$

4. There is more than one value of V for the same current I. A material exhibiting such behaviour is GaAs.

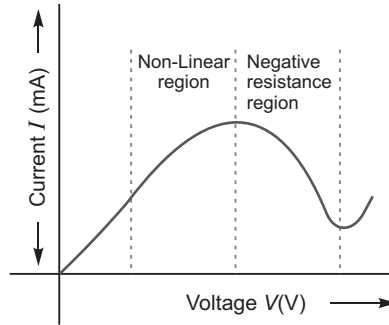

9. Torque, $pE \sin 60^\circ$
 $6\sqrt{3} pE \sin 60^\circ$
 $6\sqrt{3} pE \frac{\sqrt{3}}{2}$
 $pE \cdot 12$
 Potential energy, $U = pE \cos 60^\circ$
 $12 \cos 60^\circ$
 $12 \cdot \frac{1}{2} = 6 \text{ J}$

12. (a) de Broglie wavelength

$$\frac{h}{p} = \frac{h}{\sqrt{2mqV}}$$

For same V, $\frac{1}{\sqrt{mq}}$

$$\frac{d}{\sqrt{m_d q_d}} = \frac{\sqrt{2m_d \cdot 2q_d}}{\sqrt{m_d q_d}} = \frac{2}{1}$$

(b) Kinetic energy, $K = qV$

So, $q = q_d$

For same V, we have

$$K = K_d$$

20. The energy of electron in the n th orbit of hydrogen atom is

$$E_n = \frac{13.6}{n^2} \text{ eV}$$

when the incident beam of energy 12.3 eV is absorbed by hydrogen atom. Let the electron jump from $n = 1$ to $n = n$ level.

$$E_n = E_1 \frac{13.6}{n^2}$$

$$12.3 = \frac{13.6}{n^2}$$

$$12.3 = 13.6 \left(1 - \frac{1}{n^2}\right)$$

$$\frac{12.3}{13.6} = 1 - \frac{1}{n^2}$$

$$0.9 = 1 - \frac{1}{n^2}$$

$$n^2 = 10 \quad n = 3$$

That is the hydrogen atom would be excited upto second excited state.

For Lyman Series

$$\frac{1}{\lambda} = R \left(\frac{1}{n_f^2} - \frac{1}{n_i^2} \right)$$

$$\frac{1}{\lambda} = 1.097 \times 10^7 \left(\frac{1}{1} - \frac{1}{9} \right)$$

$$\frac{1}{\lambda} = 1.097 \times 10^7 \times \frac{8}{9}$$

$$\lambda = \frac{9}{8 \times 1.097 \times 10^7} = 1.025 \times 10^{-7} = 102.5 \text{ nm}$$

For Balmer Series

$$\frac{1}{\lambda} = 1.097 \times 10^7 \left(\frac{1}{4} - \frac{1}{16} \right)$$

$$\frac{1}{\lambda} = 1.097 \times 10^7 \times \frac{3}{16}$$

$$\lambda = 4.86 \times 10^{-7} \text{ m} = 486 \text{ nm}$$

24. (a) em waves : Y-rays

Range : 10^{19} Hz to 10^{23} Hz

- (b) This is because the special glass goggles protect the eyes from large amount of UV radiations produced by welding arcs.
- (c) Infrared waves are called heat waves because water molecules present in the materials readily absorb the infra red rays get heated up.

Application: They are used in green houses to warm the plants.

25. Current flowing in the potentiometer

$$I = \frac{V}{R_1 + R_2}$$

$$= \frac{8}{5 + 15} \text{ A} = \frac{8}{20} \text{ A} = 0.4 \text{ A}$$

Potential drop across the potentiometer wire

$$V = IR$$

$$= 0.4 \times 5 = 2 \text{ V}$$

Potential gradient

$$K = \frac{V}{l}$$

$$= \frac{2}{1} = 2 \text{ Vm}^{-1}$$

Unknown emf of the cell = kl

$$= 2 \times 0.6 \text{ V} = 1.2 \text{ V}$$



CBSE Examination Paper All India-2014



Time allowed : 3 hours

Maximum marks: 70

General Instructions: Same as CBSE Examination Paper Delhi-2014.

SET-I

- Using the concept of force between two infinitely long parallel current carrying conductors, define one ampere of current.
- To which part of the electromagnetic spectrum does a wave of frequency 5×10^{19} Hz belong?
- Two equal balls having equal positive charge ' q ' coulombs are suspended by two insulating strings of equal length. What would be the effect on the force when a plastic sheet is inserted between the two?
- Define intensity of radiation on the basis of photon picture of light. Write its SI unit.
- The electric current flowing in a wire in the direction from B to A is decreasing. Find out the direction of the induced current in the metallic loop kept above the wire as shown.

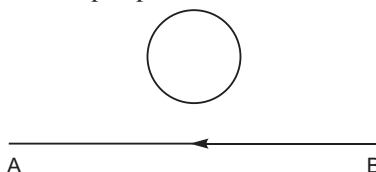

- Why is it found experimentally difficult to detect neutrinos in nuclear β -decay?
- Why is the use of AC voltage preferred over DC voltage? Give two reasons.
- A biconvex lens made of a transparent material of refractive index 1.25 is immersed in water of refractive index 1.33. Will the lens behave as a converging lens? Give reason.
- Using Rutherford model of the atom, derive the expression for the total energy of the electron in hydrogen atom. What is the significance of total negative energy possessed by the electron?

OR

Using Bohr's postulates of the atomic model, derive the expression for radius of n^{th} electron orbit. Hence obtain the expression for Bohr's radius.

- A parallel plate capacitor of capacitance C is charged to a potential V . It is then connected to another uncharged capacitor having the same capacitance. Find out the ratio of the energy stored in the combined system to that stored initially in the single capacitor.
- Considering the case of a parallel plate capacitor being charged, show how one is required to generalise Ampere's circuital law to include the term due to displacement current.

12. A cell of emf ' E ' and internal resistance ' r ' is connected across a variable resistor ' R '. Plot a graph showing variation of terminal voltage ' V ' of the cell versus the current ' I '. Using the plot, show how the emf of the cell and its internal resistance can be determined.
13. Explain, with the help of a circuit diagram, the working of a p - n junction diode as a half-wave rectifier.
14. Estimate the average drift speed of conduction electrons in a copper wire of cross-sectional area $1.0 \times 10^{-7} \text{ m}^2$ carrying a current of 1.5 A. Assume the density of conduction electrons to be $9 \times 10^{28} \text{ m}^{-3}$.
15. Two monochromatic rays of light are incident normally on the face AB of an isosceles right-angled prism ABC. The refractive indices of the glass prism for the two rays '1' and '2' are respectively 1.35 and 1.45. Trace the path of these rays after entering through the prism.

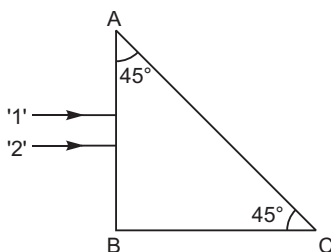

16. Write the functions of the following in communication systems:
 - (i) Transducer
 - (ii) Repeater
17. Show diagrammatically the behaviour of magnetic field lines in the presence of (i) paramagnetic and (ii) diamagnetic substances. How does one explain this distinguishing feature?
18. Draw a circuit diagram of n - p - n transistor amplifier in CE configuration. Under what condition does the transistor act as an amplifier?
19. (a) Using the phenomenon of polarisation, show how transverse nature of light can be demonstrated.
 (b) Two polaroids P_1 and P_2 are placed with their pass axes perpendicular to each other. Unpolarised light of intensity I_0 is incident on P_1 . A third polaroid P_3 is kept in between P_1 and P_2 such that its pass axis makes an angle of 30° with that of P_1 . Determine the intensity of light transmitted through P_1 , P_2 and P_3 .
20. Define the term 'mutual inductance' between the two coils.
 Obtain the expression for mutual inductance of a pair of long coaxial solenoids each of length l and radii r_1 and r_2 ($r_2 > r_1$). Total number of turns in the two solenoids are N_1 and N_2 respectively.
21. Answer the following:
 - (a) Why are the connections between the resistors in a meter bridge made of thick copper strips?
 - (b) Why is it generally preferred to obtain the balance point in the middle of the meter bridge wire?
 - (c) Which material is used for the meter bridge wire and why?

OR

A resistance of R draws current from a potentiometer as shown in the figure. The potentiometer has a total resistance R_0 . A voltage V is supplied to the potentiometer. Derive an expression for the voltage across R when the sliding contact is in the middle of the potentiometer.

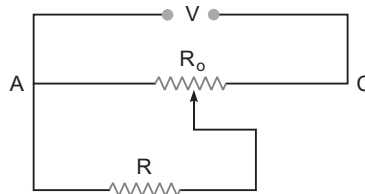

22. A convex lens of focal length 20 cm is placed coaxially with a convex mirror of radius of curvature 20 cm. The two are kept at 15 cm from each other. A point object lies 60 cm in front of the convex lens. Draw a ray diagram to show the formation of the image by the combination. Determine the nature and position of the image formed.
23. A voltage $V = V_0 \sin t$ is applied to a series LCR circuit. Derive the expression for the average power dissipated over a cycle.
Under what condition is (i) no power dissipated even though the current flows through the circuit, (ii) maximum power dissipated in the circuit?
24. Write any two distinguishing features between conductors, semiconductors and insulators on the basis of energy band diagrams.
25. For the past some time, Aarti had been observing some erratic body movement, unsteadiness and lack of coordination in the activities of her sister Radha, who also used to complain of severe headache occasionally. Aarti suggested to her parents to get a medical check-up of Radha. The doctor thoroughly examined Radha and diagnosed that she has a brain tumour.
(a) What, according to you, are the values displayed by Aarti?
(b) How can radioisotopes help a doctor to diagnose brain tumour?
26. Write two basic modes of communication. Explain the process of amplitude modulation. Draw a schematic sketch showing how amplitude modulated signal is obtained by superposing a modulating signal over a sinusoidal carrier wave.
27. An electron microscope uses electrons accelerated by a voltage of 50 kV. Determine the de-Broglie wavelength associated with the electrons. Taking other factors, such as numerical aperture etc. to be same, how does the resolving power of an electron microscope compare with that of an optical microscope which uses yellow light?
28. Draw a labelled diagram of Van de Graaff generator. State its working principle to show how by introducing a small charged sphere into a larger sphere, a large amount of charge can be transferred to the outer sphere. State the use of this machine and also point out its limitations.

OR

(a) Deduce the expression for the torque acting on a dipole of dipole moment p in the presence of a uniform electric field E .

(b) Consider two hollow concentric spheres, S_1 and S_2 , enclosing charges $2Q$ and $4Q$ respectively as shown in the figure. (i) Find out the ratio of the electric flux through them. (ii) How will the electric flux through the sphere S_1 change if a medium of dielectric constant ' ϵ_r ' is introduced in the space inside S_1 in place of air? Deduce the necessary expression.

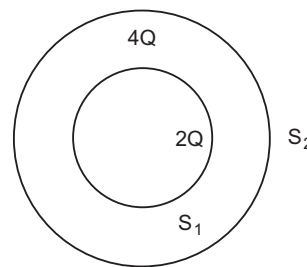

29. (a) In Young's double slit experiment, describe briefly how bright and dark fringes are obtained on the screen kept in front of a double slit. Hence obtain the expression for the fringe width.
(b) The ratio of the intensities at minima to the maxima in the Young's double slit experiment is 9 : 25. Find the ratio of the widths of the two slits.

OR

(a) Describe briefly how a diffraction pattern is obtained on a screen due to a single narrow slit illuminated by a monochromatic source of light. Hence obtain the conditions for the angular width of secondary maxima and secondary minima.

- (b) Two wavelengths of sodium light of 590 nm and 596 nm are used in turn to study the diffraction taking place at a single slit of aperture 2×10^{-6} m. The distance between the slit and the screen is 1.5 m. Calculate the separation between the positions of first maxima of the diffraction pattern obtained in the two cases.
30. (a) Deduce an expression for the frequency of revolution of a charged particle in a magnetic field and show that it is independent of velocity or energy of the particle.
- (b) Draw a schematic sketch of a cyclotron. Explain, giving the essential details of its construction, how it is used to accelerate the charged particles.

OR

- (a) Draw a labelled diagram of a moving coil galvanometer. Describe briefly its principle and working.
- (b) Answer the following:
- Why is it necessary to introduce a cylindrical soft iron core inside the coil of a galvanometer?
 - Increasing the current sensitivity of a galvanometer may not necessarily increase its voltage sensitivity. Explain, giving reason.

SET-II (Questions Uncommon to Set-I)

1. A conducting loop is held above a current carrying wire 'PQ' as shown in the figure. Depict the direction of the current induced in the loop when the current in the wire PQ is constantly increasing.

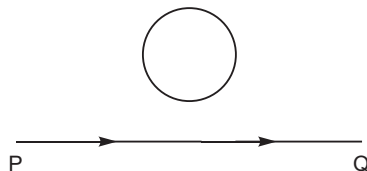

4. Why do the electrostatic field lines not form closed loops?
5. A biconvex lens made of a transparent material of refractive index 1.5 is immersed in water of refractive index 1.33. Will the lens behave as a converging or a diverging lens? Give reason.
6. The graph shows the variation of stopping potential with frequency of incident radiation for two photosensitive metals A and B. Which one of the two has higher value of work-function? Justify your answer.

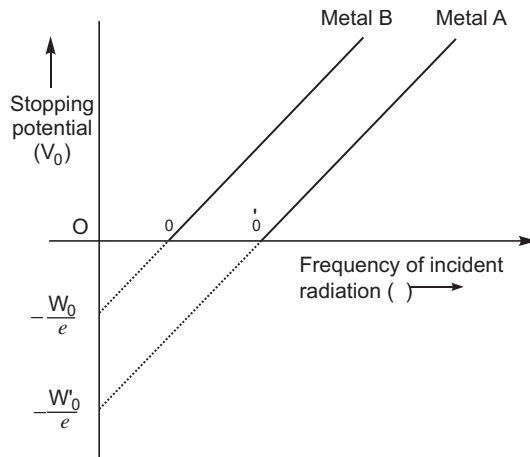

7. To which part of the electromagnetic spectrum does a wave of frequency 3×10^{13} Hz belong?
9. Estimate the average drift speed of conduction electrons in a copper wire of cross-sectional area $2.5 \times 10^{-7} \text{ m}^2$ carrying a current of 1.8 A. Assume the density of conduction electrons to be $9 \times 10^{28} \text{ m}^{-3}$.
12. Two monochromatic rays of light are incident normally on the face AB of an isosceles right-angled prism ABC. The refractive indices of the glass prism for the two rays '1' and '2' are respectively 1.3 and 1.5. Trace the path of these rays after entering through the prism.

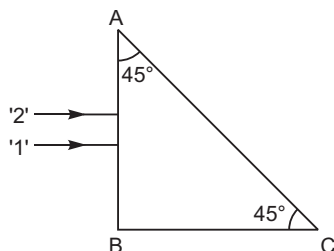

13. Write the functions of the following in communication systems:
- Transmitter
 - Modulator
21. (a) Show, with the help of a diagram, how unpolarised sunlight gets polarised due to scattering.
 (b) Two polaroids P_1 and P_2 are placed with their pass axes perpendicular to each other. Unpolarised light of intensity I_0 is incident on P_1 . A third polaroid P_3 is kept in between P_1 and P_2 such that its pass axis makes an angle of 45° with that of P_1 . Determine the intensity of light transmitted through P_1 , P_2 and P_3 .
22. Define the term self-inductance of a solenoid. Obtain the expression for the magnetic energy stored in an inductor of self-inductance L to build up a current I through it.
24. A convex lens of focal length 20 cm is placed coaxially with a concave mirror of focal length 10 cm at a distance of 50 cm apart from each other. A beam of light coming parallel to the principal axis is incident on the convex lens. Find the position of the final image formed by this combination. Draw the ray diagram showing the formation of the image.

SET-III (Questions Uncommon to Set-I and II)

2. The graph shows variation of stopping potential V_0 versus frequency of incident radiation ν for two photosensitive metals A and B. Which of the two metals has higher threshold frequency and why?

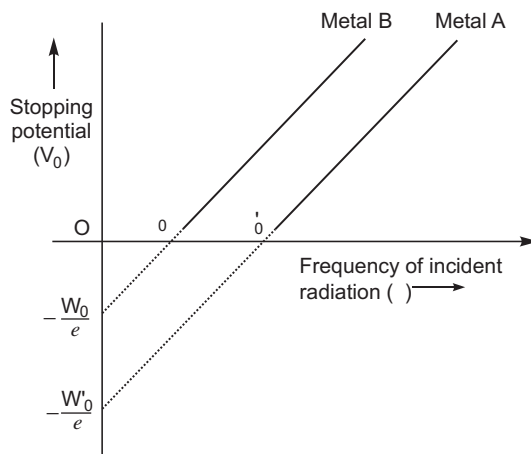

5. Why do the electric field lines never cross each other?
6. To which part of the electromagnetic spectrum does a wave of frequency 5×10^{11} Hz belong?
10. Estimate the average drift speed of conduction electrons in a copper wire of cross-sectional area $2.5 \times 10^{-7} \text{ m}^2$ carrying a current of 2.7 A. Assume the density of conduction electrons to be $9 \times 10^{28} \text{ m}^{-3}$.
18. Write the functions of the following in communication systems:
 - (i) Receiver
 - (ii) Demodulator
19. A convex lens of focal length 20 cm is placed coaxially with a convex mirror of radius of curvature 20 cm. The two are kept 15 cm apart. A point object is placed 40 cm in front of the convex lens. Find the position of the image formed by this combination. Draw the ray diagram showing the image formation.
25. (a) A rod of length l is moved horizontally with a uniform velocity ' v ' in a direction perpendicular to its length through a region in which a uniform magnetic field is acting vertically downward. Derive the expression for the emf induced across the ends of the rod.
(b) How does one understand this motional emf by invoking the Lorentz force acting on the free charge carriers of the conductor? Explain.



Solutions

SET-I

- One ampere is the value of steady current which when maintained in each of the two very long, straight, parallel conductors of negligible cross-section and placed one metre apart in vacuum would exert a force of 2×10^{-7} N on 1 metre length of either wire.
- X-rays or γ -rays.
- Force will decrease.

Reason: Force between two charges each 'q' in vacuum is

$$F_0 = \frac{1}{4\pi\epsilon_0} \cdot \frac{q^2}{r^2}$$

On inserting a plastic sheet (a dielectric $K > 1$)

$$\text{Then } F = \frac{1}{4\pi\epsilon_0 K} \cdot \frac{q^2}{r^2} \quad \text{i.e.,} \quad \text{Force } F = \frac{F_0}{K}$$

The force between charged balls will decrease.

- The amount of light energy or photon energy incident per metre square per second is called intensity of radiation.

$$\text{SI unit : } \frac{\text{W}}{\text{m}^2} \text{ or } \text{J/s}\cdot\text{m}^2$$

- The current in the wire produces a magnetic field vertically downward in the vicinity of the coil. When the current in wire BA decreases, according to Lenz's law, the current induced in the coil opposes this decrease; so the current in the coil will be in **clockwise direction**.

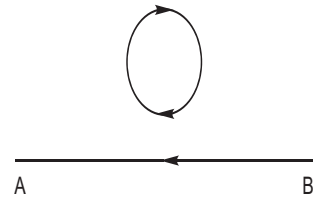

- Neutrinos are chargeless (neutral) and almost massless particles that hardly interact with matter.
- The generation of AC is more economical than DC.
 - Alternating voltage can be stepped up or stepped down as per requirement during transmission from power generating station to the consumer.
 - Alternating current in a circuit can be controlled by using wattless devices like the choke coil.
 - Alternating voltages can be transmitted from one place to another, with much lower energy loss in the transmission line.

- As a diverging lens

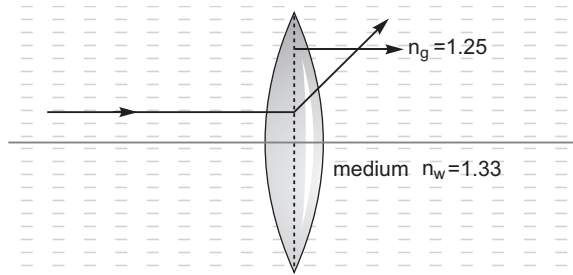

As the light travels from rarer to denser, it diverges from its path.

Alternate method

On using thin lens maker formula

$$\frac{1}{f_w} = \frac{n_g}{n_m} \left(\frac{1}{R_1} - \frac{1}{R_2} \right)$$

On using sign convention $R_1 = +ve$, $R_2 = -ve$ and $n_g = 1.25$ and $n_m = 1.33$

$$\frac{1}{f_w} = \frac{1.25}{1.33} \left(\frac{1}{R_1} - \frac{1}{R_2} \right)$$

$$\frac{1}{R_1} - \frac{1}{R_2} = +ve \text{ value and } \frac{1.25}{1.33} \left(\frac{1}{R_1} - \frac{1}{R_2} \right) = -ve \text{ value}$$

Hence $f_w = -ve$. So it behaves as a diverging lens.

9. From Rutherford atom model

$$\frac{mv^2}{r} = \frac{1}{4\pi\epsilon_0} \cdot \frac{Ze^2}{r^2}$$

$$mv^2 = \frac{1}{4\pi\epsilon_0} \cdot \frac{Ze^2}{r} \quad \dots(i)$$

Potential energy between two charges

$$U = \frac{1}{4\pi\epsilon_0} \frac{q_1q_2}{r} = \frac{1}{4\pi\epsilon_0} \frac{(Ze)(-e)}{r} = -\frac{1}{4\pi\epsilon_0} \frac{Ze^2}{r} \quad \dots(ii)$$

Total energy of the electron, $E = PE + KE$

$$E = -\frac{1}{4\pi\epsilon_0} \cdot \frac{Ze^2}{r} + \frac{1}{2}mv^2 \quad \dots(iii)$$

From equation (i) and (iii)

$$E = -\frac{1}{4\pi\epsilon_0} \cdot \frac{Ze^2}{r} + \frac{1}{2} \left(\frac{1}{4\pi\epsilon_0} \cdot \frac{Ze^2}{r} \right)$$

$$E = \frac{1}{2} \left(\frac{1}{4\pi\epsilon_0} \cdot \frac{Ze^2}{r} \right) - \frac{1}{4\pi\epsilon_0} \cdot \frac{Ze^2}{r}$$

Negative sign indicates that the electron remains bound with the nucleus (or electron-nucleus form an attractive system).

OR

According to Bohr's second postulate, angular momentum of the revolving electron

$$mvr = \frac{nh}{2\pi} \quad \dots (i)$$

From coulomb's law

$$\frac{1}{4\pi\epsilon_0} \cdot \frac{Ze^2}{r^2} = \frac{mv^2}{r}$$

$$mv^2r = \frac{1}{4\pi\epsilon_0} \cdot Ze^2 \quad \dots (ii)$$

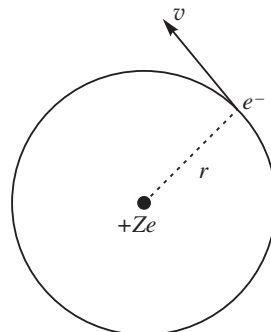
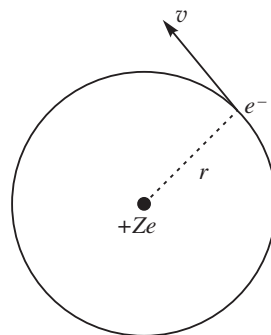

On solving equation (i) and (ii)

$$m \frac{nh}{2mr} = r \frac{1}{4} \cdot Ze^2$$

$$\frac{n^2 h^2}{4^2 mr} = \frac{1}{4} \cdot Ze^2$$

$$r = \frac{4}{4^2} \frac{n^2 h^2}{mZe^2} = \frac{n^2 h^2}{mZe^2}$$

For Bohr. radius, $n = 1$ i.e., for K shell

$$r_B = \frac{h^2}{mZe^2}$$

10. The charge on the capacitor $q = CV$ and initial energy stored in the capacitor

$$U_1 = \frac{1}{2} \frac{q^2}{C} = \frac{1}{2} CV^2 \quad \dots(i)$$

- (a) If another uncharged capacitor is connected in series then the same amount of the charge will transfer as shown in figure.

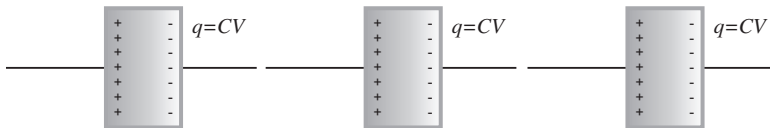

Keeping charge constant, and final voltage $v = 2v$

$$U_f = \frac{1}{2} \frac{q^2}{C} = \frac{1}{2} \frac{q^2}{2C} = \frac{q^2}{4C} \quad \dots(ii)$$

$$U_f : U_i = \frac{q^2}{4C} : \frac{q^2}{2C} = 1 : 2$$

Alternately

$$U_f : U_i = \frac{1}{2} CV^2 : \frac{1}{2} C_S \cdot V^2$$

$$\frac{1}{2} CV^2 : \frac{1}{2} \frac{C}{2} (2V)^2 = \frac{1}{2} CV^2 : CV^2 = 1 : 2$$

- 11.

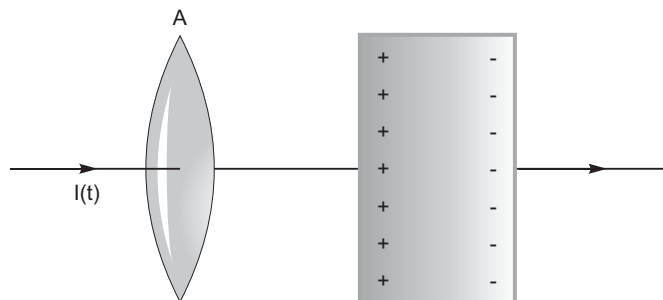

During charging C capacitor, a time varying current $I(t)$ flows through the conducting wire, so on applying Ampere's circuital law (for loop A) $\oint B \cdot dl = \mu_0 I(t)$ $\dots (i)$

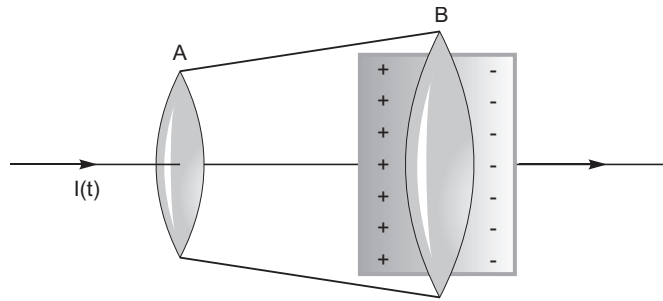

Now we consider a pot like surface enclosing the positively charged plate and nowhere touches the conducting wire,

$$\oint B \cdot dl = 0 \quad \dots (ii)$$

From equation (i) and (ii), we have a contradiction

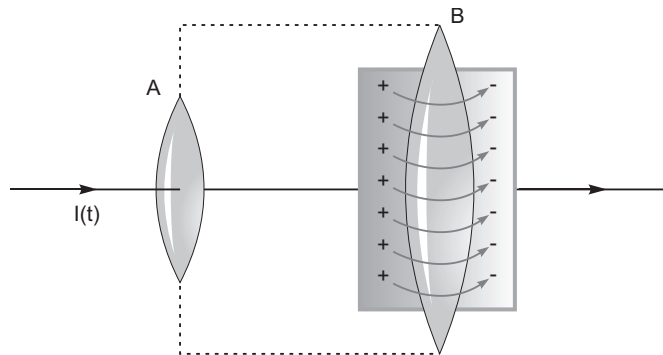

If surfaces A and B forms a tiffin box, and electric field E is passing through the surface (B); constitute an electric flux

$$|E||A| = \frac{1}{\epsilon_0} |A| \frac{Q}{A} = \frac{Q}{\epsilon_0} \quad \dots (iii)$$

If the charge on the plate in the tiffin box is changing with time, there must be a current between the plates.

From equation (iii)

$$I = \frac{dQ}{dt} = \frac{d}{dt} \left(\epsilon_0 \oint E \cdot dA \right) = \epsilon_0 \frac{d}{dt} \oint E \cdot dA$$

This is the missing term in Ampere's circuital law.

The inconsistency may disappear if displacement current is included between the plates.

So generalised Ampere's circuital law can be given as

$$\oint B \cdot dt = \mu_0 I(t) + \mu_0 \epsilon_0 \frac{d}{dt} \oint E \cdot dt$$

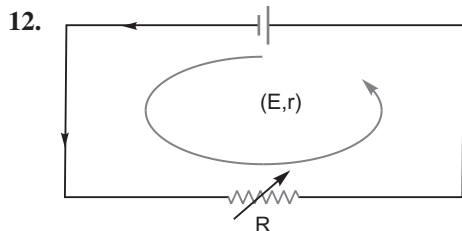

Suppose a current I flows through the circuit and using loop rule

$$E - IR - Ir = 0$$

$$E - Ir = V \quad [V = IR]$$

$$V = E - Ir$$

... (i)

If terminal voltage V is the function of current I , Reason – Equation of straight line, $y = mx + c$

Then,

Using the graph

For point A, $I = 0$ and on using equation (i)

$$V = E - 0 \cdot r = E$$

Hence voltage intercept (intercept on the vertical axis) measures emf of the cell.

For point B, $V = 0$, from equation (i)

$$0 = E - Ir$$

$$r = \frac{E}{I}$$

i.e., negative of the slope of $V - I$ graph measures the internal resistance r .

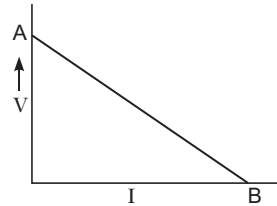

13.

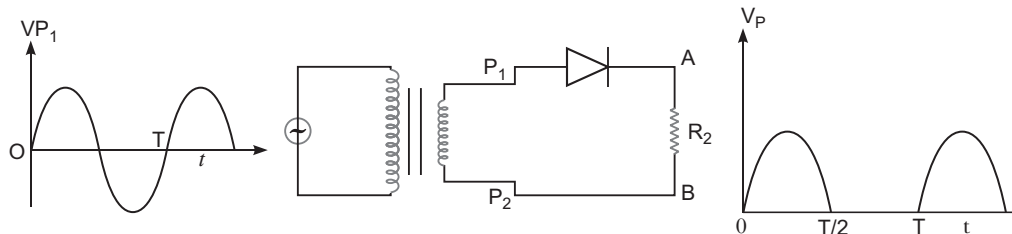

Step down Transformer

Working

- (i) During positive half cycle of input alternating voltage, the diode is forward biased and a current flows through the load resistor R_L , and we get an output voltage.
- (ii) During other negative half cycle of the input alternating voltage, the diode is reverse biased and it does not conduct (under break down region).

Hence AC voltage can be rectified in the pulsating and unidirectional voltage.

14. Flow of current in the conductor due to drift velocity of the free electrons is given by

$$I = neAv_d$$

$$v_d = \frac{I}{neA} = \frac{15}{9 \times 10^{28} \times 1.6 \times 10^{-19} \times 1.0 \times 10^{-7}}$$

$$1.048 \times 10^{-3} \text{ m/s} \approx 1 \text{ mm/s}$$

15. As we know that the critical angle depends on refractive index as

$$\sin i_c = \frac{1}{n}$$

If $\sqrt{2} = 1.414$ then $i_c = 45^\circ$

If $n = 1.35$, $i_c = \sin^{-1} \frac{1}{1.35} = 45^\circ$

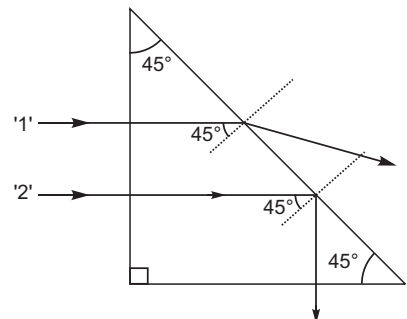

So the ray 1 refracted out.

If $1.45, c \sin^{-1} \frac{1}{1.45} 45$

So the ray 2, totally reflect back.

- 16. (i) **Function of Transducer:** Any device that converts one form of energy into another.
- (ii) **Function of Repeater:** A repeater, picks up the signals from the transmitter, amplifies and retransmits it to the next receiver sometimes with a change in carrier frequency.

17.

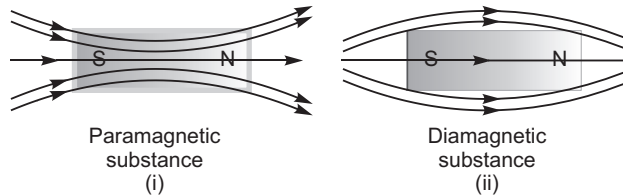

A paramagnetic material tends to move from weaker field to stronger field regions of the magnetic field. So, the number of lines of magnetic field increases when passing through it.

Magnetic dipole moments are induced in the direction of magnetic field.

Paramagnetic materials has a small positive susceptibility.

A diamagnetic material tends to move from stronger field to weaker field region of the magnetic field.

So, the number of lines of magnetic field passing through it decreases.

Magnetic dipole moments are induced in the opposite direction of the applied magnetic field.

Diamagnetic materials has a negative susceptibility in the range $(-1 < \chi < 0)$.

- 18. A circuit diagram of $n-p-n$ transistor as an amplifier is shown in figure.

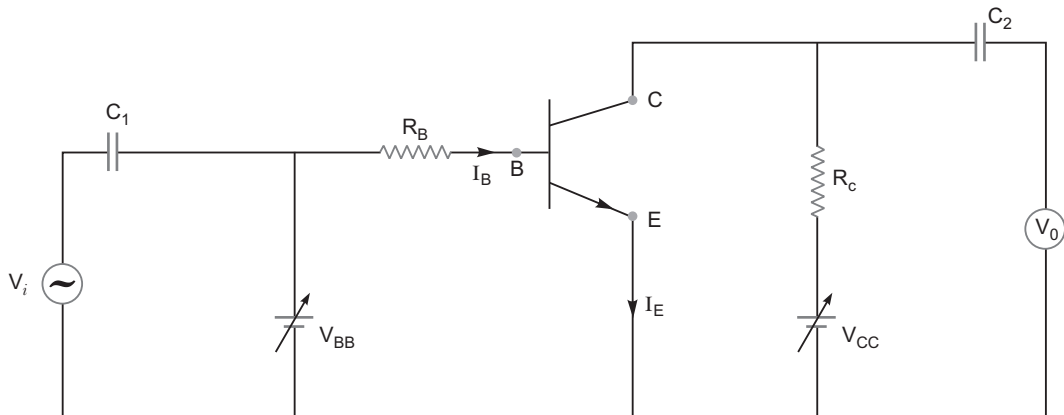

Condition:

The base-emitter junction of the transistor must be forward biased and the collector-emitter junction must be reverse biased.

- 19. (a) Light from a source S is allowed to fall normally on the flat surface of a thin plate of a tourmaline crystal, cut parallel to its axis. Only a part of this light is transmitted through A . If now the plate A is rotated, the character of transmitted light remains unchanged. Now another similar plate B is placed at some distance from A such that the axis of B is parallel to that of A . If the light transmitted through A is passed through B , the light is almost completely transmitted through B and no change is observed in the light coming out of B .

If now the crystal A is kept fixed and B is gradually rotated in its own plane, the intensity of light emerging out of B decreases and becomes zero when the axis of B is perpendicular to that of A . If B is further rotated, the intensity begins to increase and becomes maximum when the axes of A and B are again parallel.

Thus, we see that the intensity of light transmitted through B is maximum when axes of A and B are parallel and minimum when they are at right angles.

From this experiment, it is obvious that light waves are transverse and not longitudinal; because, if they were longitudinal, the rotation of crystal B would not produce any change in the intensity of light.

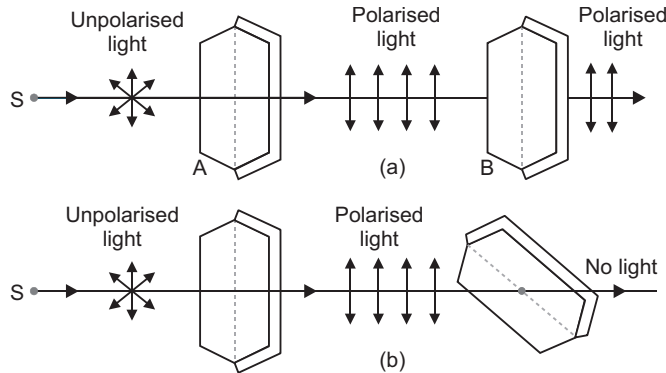

(b) If light of intensity I_0 passes through the first polaroid.

The intensity of light transmitted through P_1 $I_1 = \frac{I_0}{2}$

If axis of polaroids P_1 and P_3 are at 30° .

So intensity of light transmitted through P_3 is given by

$$I_3 = I_1 \cos^2 30$$

$$\frac{I_0}{2} \cdot \frac{\sqrt{3}}{2}^2 = \frac{3I_0}{8}$$

Light transmitted through P_3 is allowed to pass through P_2 .

So intensity of light transmitted through P_2 $I_2 = I_3 \cos^2 60$

$$\frac{3I_0}{8} \cdot \frac{1}{2}^2 = \frac{3I_0}{32}$$

20.

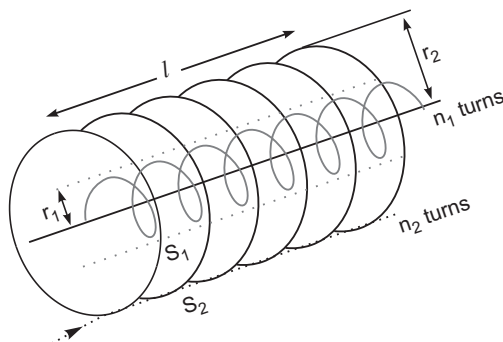

From relation $\phi_2 = MI_1$ or $\phi_1 = MI_2$

Mutual inductance between a pair of coils is equal to the magnetic flux linked with one of the coils due to unit current flow in the another coil.

From relation $E_2 = M_{21} \frac{dI_1}{dt}$ or $E_1 = M_{12} \frac{dI_2}{dt}$

The mutual inductance for a pair of coils is equal to the magnitude of the induced emf in one of the coils, when the current in the other coil changes at rate 1 Amp/sec.

When a current I_2 is set up through outer coil S_2 , it in turn sets up a magnetic flux through coil S_1 , so magnetic flux through S_1 is given by

$$\phi_1 = M_{12} I_2 \quad \dots (i)$$

The magnetic field due to the current I_2 in S_2 is $\mu_0 n_2 I_2$.

This magnetic field, on passing through the coil S_1 produces a magnetic flux

$$\phi_1 = (\mu_0 n_2 I_2)(n_1 l) r_1^2$$

$$\phi_1 = \mu_0 n_1 n_2 r_1^2 l I_2 \quad \dots (ii)$$

where n, l is the total number of turns in solenoid S_1 .

From equation (i) and (ii)

$$M_{12} I_2 = \mu_0 n_1 n_2 l r_1^2 I_2$$

$$M_{12} = \mu_0 n_1 n_2 (r_1^2) l$$

21. (a) A thick copper strip offers a negligible resistance, so does not alter the value of resistances used in the meter bridge.
- (b) If the balance point is taken in the middle, it is done to minimise the percentage error in calculating the value of unknown resistance.
- (c) Generally alloys magnin/constantan/nichrome are used in meter bridge, because these materials have low temperature coefficient of resistivity.

OR

Net resistance between points A and C

$$R_{net} = R_p + \frac{R_o}{2}$$

$$= \frac{R_0}{2} + \frac{R}{2} = \frac{R_0 + R}{2}$$

$$= \frac{R_0(R_0 + 2R) + 2R_0R}{2(R_0 + 2R)} = \frac{R_0(R_0 + 4R)}{2(R_0 + 2R)}$$

Net current in between points A and C

$$I_{net} = \frac{V}{R_0(R_0 + 4R)}$$

Current in Resistance R

$$V_p = I_{net} R = I_1 \frac{R_0}{2} = I_2(R)$$

$$I_2 = \frac{I_{net} R}{R}$$

$$\frac{1}{R} \cdot \frac{V}{R_0(R_0 + 4R)} \cdot \frac{2(R_0 + 2R)}{\frac{R_0}{2} R} = \frac{2V}{(R_0 + 4R)}$$

$$V = I_2 R \frac{2V}{(R_0 + 4R)} \Rightarrow I_2 = \frac{2VR}{(R_0 + 4R)}$$

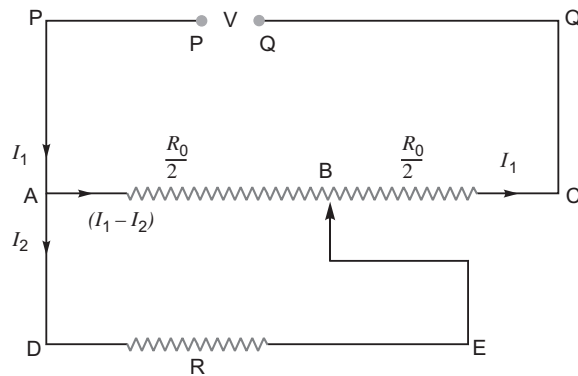
Alternative method

 In loop *ABEDA*

$$(I_1 - I_2) \frac{R_0}{2} - I_2 R = 0$$

$$I_1 \frac{R_0}{2} - I_2 R - \frac{R_0}{2} I_2 = 0 \quad (R_0 + 2R)$$

$$I_1 R_0 - I_2 (R_0 + 2R) = 0 \quad \dots (i)$$

 In Loop *PABCQP*

$$V - (I_1 - I_2) \frac{R_0}{2} - I_1 \frac{R_0}{2} - I_2 \frac{R_0}{2} - I_1 \frac{R_0}{2} = 0$$

$$V - I_1 R_0 - I_2 \frac{R_0}{2} = 0 \quad \dots (ii)$$

From equation (i) and (ii)

$$V - R_0 \frac{I_2 (R_0 + 2R)}{R} - I_2 \frac{R_0}{2} = 0$$

$$I_2 \frac{R_0 (R_0 + 2R)}{R} + \frac{R_0}{2} I_2 = V$$

$$\frac{I_2 R_0}{2R} (2(R_0 + 2R) + R) = I_2 \frac{R_0}{2R} (R_0 + 2R)$$

$$I_2 = \frac{2VR}{R_0 (R_0 + 2R)}$$

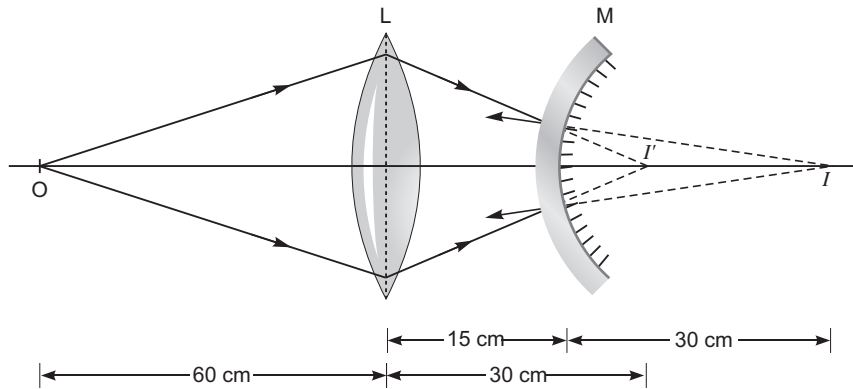

For convex lens $\frac{1}{f} = \frac{1}{v} + \frac{1}{u}$

$$\frac{1}{20} = \frac{1}{v} + \frac{1}{60}$$

$$\frac{1}{v} = \frac{1}{20} - \frac{1}{60} = \frac{3}{60} - \frac{1}{60} = \frac{2}{60} = \frac{1}{30}$$

$v = 30 \text{ cm}$

In the absence of the mirror, the lens would have formed the image of I' which acts as a virtual object for the convex mirror.

u_2 distance of virtual object I' from mirror
 $30 \text{ cm} - 15 \text{ cm} = 15 \text{ cm}$

$$f = \frac{R}{2} = \frac{20}{2} = 10 \text{ cm}$$

From mirror formula $\frac{1}{f_m} = \frac{1}{v_2} + \frac{1}{u_2}$

$$\frac{1}{10} = \frac{1}{v_2} + \frac{1}{15}$$

$$\frac{1}{v_2} = \frac{1}{10} - \frac{1}{15} = \frac{3}{30} - \frac{2}{30} = \frac{1}{30}$$

$v_2 = 30 \text{ cm}$

Hence the final image I is a virtual image formed at a distance of 30 cm to the right of convex mirror or 45 cm from the convex lens.

23.

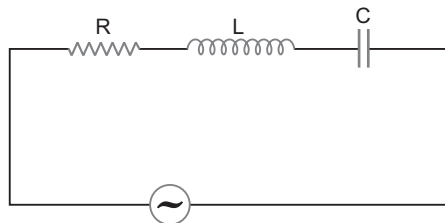

The voltage $V = V_0 \sin \omega t$ is applied across the series L – CR circuit. However due to impedance of the circuit, either current lags or leads the voltage by phase opposite so the current in the circuit is given by

$$I = I_0 \sin(\omega t - \phi)$$

Instantaneous power dissipation in the circuit

$$\begin{aligned}
 P &= VI \\
 &= V_0 \sin \omega t \cdot I_0 \sin(\omega t - \phi) \\
 &= \frac{V_0 I_0}{2} [2 \sin \omega t \cdot \sin(\omega t - \phi)] \\
 &= \frac{V_0 I_0}{2} [\cos \phi - \cos(2\omega t - \phi)]
 \end{aligned}$$

$$[\cos(A - B) = \cos(A + B) + 2 \sin A \sin B]$$

Average power loss over one complete cycle

$$\begin{aligned}
 \bar{P} &= \frac{1}{T} \int_0^T P dt \\
 &= \frac{V_0 I_0}{2T} \int_0^T \cos \phi dt - \int_0^T \cos(2\omega t - \phi) dt
 \end{aligned}$$

However

$$\begin{aligned}
 \int_0^T \cos(2\omega t - \phi) dt &= 0 \\
 \frac{V_0 I_0}{2T} \cdot \cos \phi \int_0^T dt &= \frac{V_0 I_0}{2} \cos \phi
 \end{aligned}$$

$$P_{av} = \frac{V_0}{\sqrt{2}} \cdot \frac{I_0}{\sqrt{2}} \cos \phi$$

$$P_{av} = V_{eff} \cdot I_{eff} \cos \phi$$

- (i) If phase angle $\phi = 90^\circ$ (resistance R is used in the circuit) then no power dissipated.
 (ii) If phase angle $\phi = 0$ or circuit is pure resistive (or $X_L = X_C$) at resonance then

$$\text{Max power } P = V_{eff} \times I_{eff} = \frac{V_0 I_0}{2}$$

24.

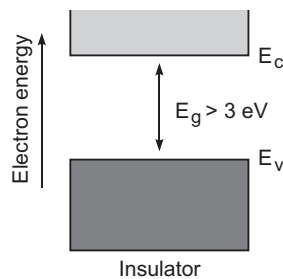
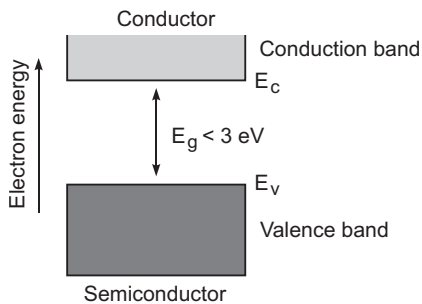
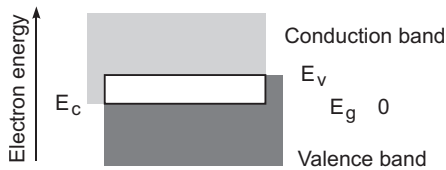

Distinguishing features

(a) In conductors: Valence band and conduction band overlap on each other.

In semiconductors: Valence band and conduction band are separated by a small energy gap.

In insulators: They are separated by a large energy gap.

(b) In conductors: Large number of free electrons are available in conduction band.

In semiconductors: A very small number of electrons are available for electrical conduction.

In insulators: Conduction band is almost empty *i.e.*, no electron is available for conduction.

25. (a) Values displayed by Aarti:

Keen observer, helpful, responsible, concerned to family, respectful towards elders in the family.

(b) Radio isotopes help the doctors in observing the difference between the movement of an appropriate radio-isotope through a normal brain and the brain having tumour in it.

26. Basic modes of communication are

(a) Point-to-point – (Telephony is an example)

(b) Broadcast – (Radio and Television)

In Amplitude modulation, the amplitude of the carrier wave is made to vary with time in accordance with the modulating signal varies with time.

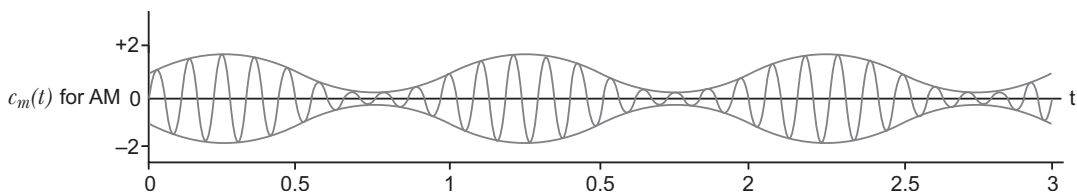

27. Wavelength associated with the particle (electron) is

$$\frac{h}{p} = \frac{h}{\sqrt{2mk}} = \frac{h}{\sqrt{2mev}} = \frac{12.27 \text{ \AA}}{\sqrt{V}}$$

$$\frac{6.63 \times 10^{-34}}{\sqrt{2 \times 9.1 \times 10^{-31} \times 1.6 \times 10^{19} \times 50 \times 10^3}}$$

$$5.34 \times 10^{-12} \text{ m}$$

The resolving power of an electron microscope is given by

$$\text{R.P.} = \frac{1}{d_{\min}} = \frac{2 \sin v}{1.22}$$

For constant numerical aperture

$$\text{R. P.} \propto \frac{1}{\lambda}$$

Wavelength of yellow light is in between 700 nm to 400 nm (say 600 nm) or 6000 Å

The wavelength of the accelerating electrons is much smaller than yellow light, hence resolving power of electron microscope is much better than optical microscope.

28. Van de Graaff generator is excluded from syllabus.

OR

(a) Expression for torque

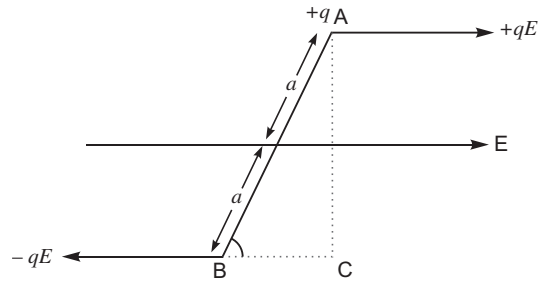

An electric dipole having charges q , and of size $2a$ is placed in uniform electric field E as shown in figure. The forces, acting on the charges are qE and qE .

The net force on the dipole is $F = qE - (-qE) = 0$

Both forces provides an equivalent torque with magnitude

$$\begin{aligned} & |qE| \cdot \text{Perpendicular distance (AC)} \\ & q|E| \cdot 2a \sin \theta \\ & = |P| |E| \sin \theta \end{aligned}$$

The direction of the torque can be given by

$$\tau = P \times E$$

(b) Using Gauss's Theorem $\oint E \cdot ds = \frac{q(T)}{\epsilon_0}$

Electric flux through sphere S_1 , $\frac{2(q)}{\epsilon_0}$

Electric flux through sphere S_2 , $\frac{(2Q - 4Q)}{\epsilon_0} = \frac{6Q}{\epsilon_0}$

Ratio $\frac{1}{\epsilon_0} \frac{2Q}{6Q} = \frac{1}{3}$

If a medium of dielectric constant $K(\epsilon_r)$ is filled in the sphere S_1 , electric flux through sphere, $\frac{1}{\epsilon_0} \frac{2Q}{K} = \frac{2Q}{K \epsilon_0}$

29. (a) Condition for formation of bright and dark fringes.

Suppose a narrow slit S is illuminated by monochromatic light of wavelength λ .

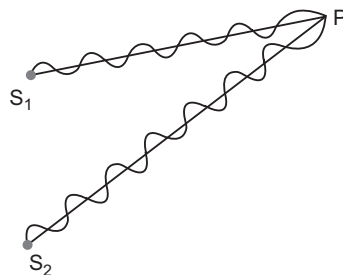

The light rays from two coherent sources S_1 and S_2 are reaching a point P , have a path difference $(S_2P - S_1P)$.

(i) If maxima (bright fringe) occurs at point P , then

$$S_2P - S_1P = n \lambda \quad (n = 0, 1, 2, 3 \dots)$$

(ii) If minima (dark fringe) occurs at point P , then

$$S_2P - S_1P = (2n - 1) \frac{\lambda}{2} \quad (n = 0, 1, 2, 3 \dots)$$

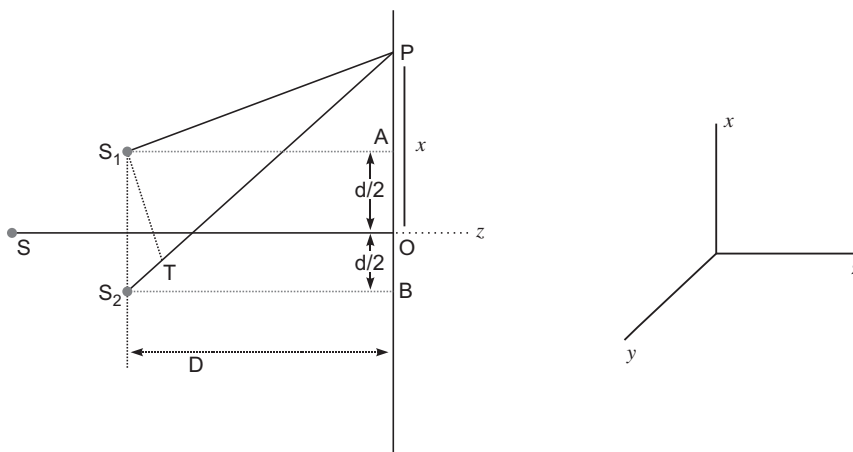

Light waves spread out from S and falls on both slits S_1 and S_2 . Then S_1 and S_2 behave like two coherent sources. Spherical waves emanating from S_1 and S_2 superpose on each other, and produces interference pattern on the screen. Consider a point P at a distance x from O , the centre of screen. The position of maxima (or minima) depends on the path difference. $(S_2P - S_1P)$.

From right angled $\triangle S_2BP$ and $\triangle S_1AP$,

$$(S_2P)^2 = (S_1P)^2 + D^2 + x \frac{d^2}{2} \quad D^2 + x \frac{d^2}{2} = 2xd$$

$$(S_2P - S_1P)(S_2P + S_1P) = 2xd$$

$$S_2P - S_1P = \frac{2xd}{(S_2P + S_1P)}$$

In practice, the point P lies very close to O , therefore

$$S_2P \approx S_1P \approx D$$

$$S_2P - S_1P \approx \frac{2xd}{2D} = \frac{xd}{D} \quad \dots (i)$$

For constructive interference (Bright fringes)

Path difference, $\frac{dx}{D} = n$ where $n = 0, 1, 2, 3 \dots$

$$x = \frac{nD}{d}$$

For $n = 0$, $x_0 = 0$ Central bright fringe

For $n = 1$, $x_1 = \frac{D}{d}$ 1st bright fringe

For $n = 2$, $x_2 = \frac{2D}{d}$ 2nd bright fringe

For $n = n$, $x_n = \frac{nD}{d}$ n th bright fringe

The distance between two consecutive bright fringes is

$$\frac{x_n}{d} - \frac{x_{n-1}}{d} = \frac{nD}{d} - \frac{(n-1)D}{d} = \frac{D}{d}$$

For destructive interference (dark fringes)

Path difference $\frac{dx}{D} = (2n-1)\frac{D}{2d}$

$$x = (2n-1)\frac{D}{2d} \quad \text{where } n = 1, 2, 3, \dots$$

For $n = 1$, $x_1 = \frac{D}{2d}$ for 1st dark fringe

For $n = 2$, $x_2 = \frac{3D}{2d}$ for 2nd dark fringe

For $n = n$, $x_n = (2n-1)\frac{D}{2d}$ for n th dark fringe.

The distance between two consecutive dark fringe is

$$(2n-1)\frac{D}{2d} - \{2(n-1)-1\}\frac{D}{2d} = \frac{D}{d}$$

The distance between two consecutive bright or dark fringes is called fringe width (w).

$$\text{Fringe width} = \frac{D}{d}$$

The expression for fringe width is free from n . Hence the width of all fringes of red light are broader than the fringes of blue light.

(b) Intensity of light (using classical theory) is given as

$I \propto (\text{Width of the slit})$

$(\text{Amplitude})^2$

$$\frac{I_{\max}}{I_{\min}} = \frac{(a_1 + a_2)^2}{(a_1 - a_2)^2} = \frac{25}{9}$$

$$\frac{a_1 + a_2}{a_1 - a_2} = \frac{5}{3} \qquad \frac{a_1}{a_2} = \frac{4}{1}$$

Intensity ratio

$$\frac{I_1}{I_2} = \frac{w_1}{w_2} = \frac{a_1^2}{a_2^2}$$

$$\frac{I_1}{I_2} = \frac{4}{1} = \frac{16}{1}$$

OR

- (a) **Diffraction of light at a single slit** : When monochromatic light is made incident on a single slit, we get diffraction pattern on a screen placed behind the slit. The diffraction pattern contains bright and dark bands, the intensity of central band is maximum and goes on decreasing on both sides.

Explanation : Let AB be a slit of width ‘ a ’ and a parallel beam of monochromatic light is incident on it. According to Fresnel the diffraction pattern is the result of superposition of a large number of waves, starting from different points of illuminated slit.

Let θ be the angle of diffraction for waves reaching at point P of screen and AN the perpendicular dropped from A on wave diffracted from B .

The path difference between rays diffracted at points A and B ,

In $\triangle ANB$, $\angle ANB = 90^\circ$ and $\angle BAN = \theta$

$$\sin \theta = \frac{BN}{AB} \text{ or } BN = AB \sin \theta$$

As AB = width of slit = a

Path difference,
 $a \sin \theta$ (i)

To find the effect of all coherent waves at P , we have to sum up their contribution, each with a different phase. This was done by Fresnel by rigorous calculations, but the main features may be explained by simple arguments given below :

At the central point C of the screen, the angle θ is zero. Hence the waves starting from all points of slit arrive in the same phase. This gives maximum intensity at the central point C .

If point P on screen is such that the path difference between rays starting from edges A and B is $\frac{a}{2}$, then path difference

$$a \sin \theta = \frac{a}{2} \implies \sin \theta = \frac{1}{2}$$

If angle θ is small, $\sin \theta \approx \theta$ (ii)

Minima : Now we divide the slit into two equal halves AO and OB , each of width $\frac{a}{2}$. Now for every point, M_1 in AO , there is a corresponding point M_2 in OB , such that $M_1M_2 = \frac{a}{2}$; Then

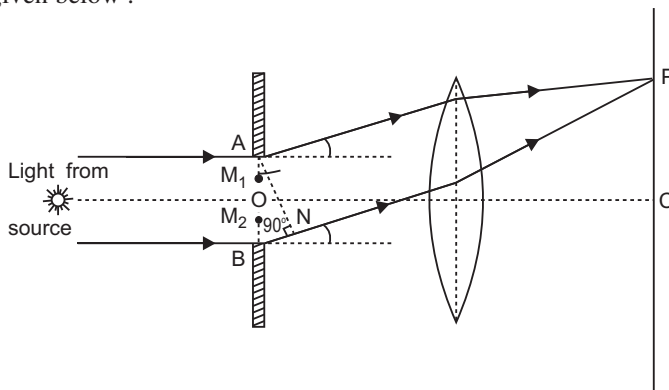

path difference between waves arriving at P and starting from M_1 and M_2 will be $\frac{a}{2} \sin \theta$.

This means that the contributions from the two halves of slit AO and OB are opposite in phase and so cancel each other. Thus equation (2) gives the angle of diffraction at which intensity falls to zero. Similarly it may be shown that the intensity is zero for $a \sin \theta = n\lambda$, with n as integer.

Thus the general condition of **minima** is

$$a \sin \theta = n\lambda \quad \dots(iii)$$

Secondary Maxima : Let us now consider angle θ such that

$$a \sin \theta = \frac{3\lambda}{2}$$

which is midway between two dark bands given by

$$a \sin \theta = \lambda \text{ and } a \sin \theta = 2\lambda$$

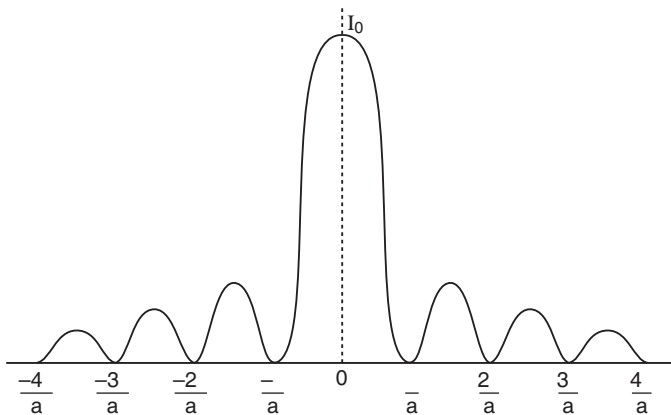

Let us now divide the slit into three parts. If we take the first two of parts of slit, the path difference between rays diffracted from the extreme ends of the first two parts

$$\frac{2}{3} a \sin \theta = \frac{2}{3} a \cdot \frac{3\lambda}{2a} = \lambda$$

Then the first two parts will have a path difference of λ and cancel the effect of each other. The

remaining third part will contribute to the intensity at a point between two minima. Clearly there will be a maxima between first two minima, but this maxima will be of much weaker intensity than central maximum. This is called *first secondary maxima*. In a similar manner we can show that there are secondary maxima between any two consecutive minima; and the intensity of maxima will go on decreasing with increase of order of maxima. In general the position of n th maxima will be given by

$$a \sin \theta = n \frac{\lambda}{2}, \quad [n = 1, 2, 3, 4, \dots] \quad \dots(iv)$$

The intensity of secondary maxima decrease with increase of order n because with increasing n , the contribution of slit decreases.

For $n = 2$, it is one-fifth, for $n = 3$, it is one-seventh and so on.

(b) Angular width of secondary maxima

$$a. \quad n \frac{1}{2}$$

$$n \frac{1}{2} \frac{D}{a}$$

and Linear width $\frac{y}{D}$

$$y = D \cdot n \frac{1}{2} \frac{D}{a}$$

If $n = 1$, and $\lambda = 590 \text{ nm}$,

$$y_1 = 1 \frac{1}{2} \frac{1D}{a} = \frac{3}{2} \frac{1D}{2a}$$

If $n = 2$, $\lambda = 596 \text{ nm}$

$$y_2 = 2 \frac{1}{2} \frac{2D}{a} = \frac{3}{2} \frac{2D}{2a}$$

$$\text{Linear separation} = y_2 - y_1 = \frac{3(2 - 1)D}{2a}$$

$$= \frac{3(596 - 590) \times 10^{-9} \times 1.5}{2 \times 2 \times 10^{-6}} = \frac{3 \times 6 \times 10^{-3} \times 1.5}{4}$$

$$= 4.5 \times 1.5 \times 10^{-3}$$

$$= 6.75 \times 10^{-3} = 6.75 \text{ mm}$$

30. Expression for the frequency of revolution

(a) When a particle of mass ' m ' and charge ' q ' enters with a velocity v in a uniform magnetic field

B it experiences a force F , where

$$F = q(v \times B)$$

Due to centripetal force (or magnetic force) the charge particle moves on a circular path of radius r . If magnetic force is perpendicular to both v and B , then

$$qvB = \frac{mv^2}{r}$$

$$r = \frac{mv}{qB}$$

If ω is the angular frequency, then $v = r\omega$, so angular frequency $\omega = \frac{qB}{m}$

which is independent of the velocity or energy of the particle.

Since $\omega = 2\pi\nu$

$$2\pi\nu = \frac{qB}{m} \quad \nu = \frac{qB}{2\pi m}$$

It is independent of velocity or energy of the particle.

- (b) **Cyclotron:** The cyclotron, devised by Lawrence and Livingston, is a device for accelerating ions to high speed by the repeated application of accelerating potentials.

Construction: The cyclotron consists of two flat semi-circular metal boxes called 'dees' and are arranged with a small gap between them. A source of ions is located near the mid-point of the gap between the dees (fig.). The dees are connected to the terminals of a radio frequency oscillator, so that a high frequency alternating potential of several million cycles per second exists between the dees. Thus dees act as electrodes. The dees are enclosed in an insulated metal box containing gas at low pressure. The whole apparatus is placed between the poles of a strong electromagnet which provides a magnetic field perpendicular to the plane of the dees.

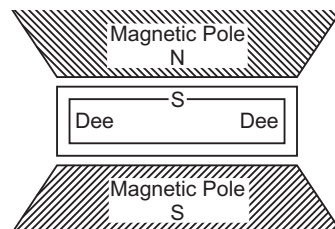

Working: The principle of action of the apparatus is shown in fig. The positive ions produced from a source S at the centre are accelerated by a dee which is at negative potential at that moment. Due to the presence of perpendicular magnetic field the ion will move in a circular path inside the dees. The magnetic field and the frequency of the applied voltages are so chosen that as the ion comes out of a dee, the dees change their polarity (positive becoming negative and vice-versa) and the ion is further accelerated and moves with higher velocity along a circular path of greater radius. The phenomenon is continued till the ion reaches at the periphery of the dees where an auxiliary negative electrode (deflecting plate) deflects the accelerated ion on the target to be bombarded.

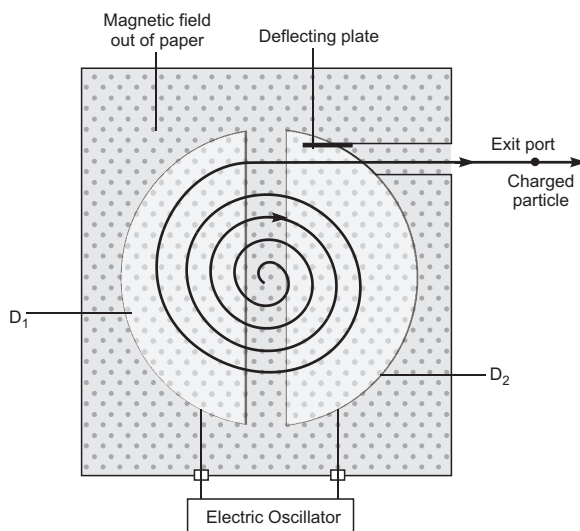

Role of electric field

- (i) Electric field accelerates the charge particle passing through the gap with the help of electric oscillator.
- (ii) Electric oscillator imparts the energy to charged particle till it comes out from the exit slit.

Role of magnetic field

As the accelerated charge particle enters normally to the uniform magnetic field, it exerts a magnetic force in the form of centripetal force and charge particle moves on a semicircular path of increasing radii in each dee (D_1 or D_2).

Expression for Period of Revolution and Frequency:

Suppose the positive ion with charge q moves in a dee with a velocity v , then,

$$qvB = \frac{mv^2}{r} \quad \text{or} \quad r = \frac{mv}{qB} \quad \dots(i)$$

where m is the mass and r the radius of the path of ion in the dee and B is the strength of the magnetic field.

The angular velocity of the ion is given by,

$$\frac{v}{r} = \frac{qB}{m} \text{ (from eq. i)} \quad \dots(ii)$$

The time taken by the ion in describing a semi-circle, *i.e.*, in turning through an angle π is,

$$t = \frac{m}{Bq} \quad \dots(iii)$$

Thus the time is independent of the speed of the ion *i.e.*, although the speed of the ion goes on increasing with increase in the radius (from eq. i) when it moves from one dee to the other, yet it takes the same time in each dee.

From eq. (iii) it is clear that for a particular ion, $\frac{m}{q}$ being known, B can be calculated for producing resonance with the high frequency alternating potential.

OR

(a) Diagram of moving coil galvanometer

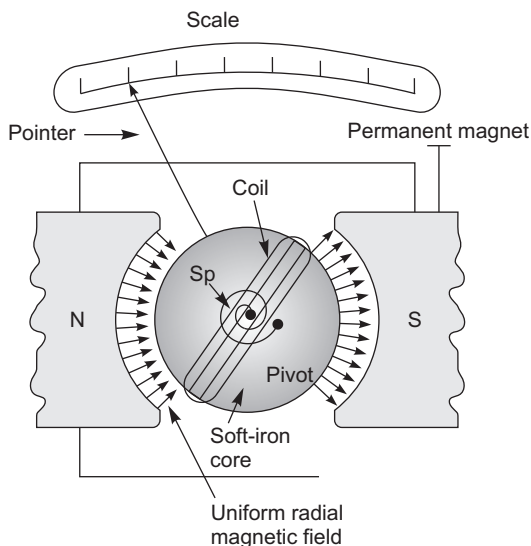

Principle: A current carrying coil, placed in a uniform magnetic field, experiences a torque

$$NIBA \sin \theta$$

$$m \times B$$

where m is the magnetic moment of the coil.

Working: If plane of the coil is parallel to the magnetic field lines, the coil experiences a maximum torque, and it tends to rotate the coil.

Spring attached with the coil produces a counter torque, which balances the magnetic torque, and coil deflects by angle θ . So in equilibrium

$$K \theta = NIBA \sin \theta$$

where K is torsional constant.

$$\theta = \frac{K}{NBA}$$

It means the deflection of the coil is proportional to the current flowing through the coil.

(b) (i) The cylindrical, soft iron core makes the (i) field radial and (ii) increases the strength of the magnetic field, *i.e.*, the magnitude of the torque.

(ii) Current sensitivity $S_i = \frac{NBA}{I K}$

and voltage sensitivity $S_v = \frac{NBA}{V IR KR}$

Since the resistance of the coil may vary, it means an increase in current sensitivity may not necessarily increase the voltage sensitivity.

SET-II (Questions Uncommon to Set-I)

1. Clockwise

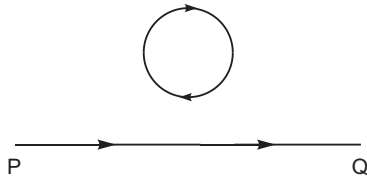

4. The electrostatic field lines start from positive charge and end on negative charge.

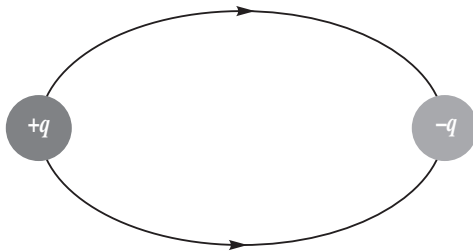

5. As the light travels from denser to rarer medium, so the lens behaves as converging lens.

Alternative method

From lens makers formula

$$\frac{1}{f_w} = \frac{n_r}{n_w} \left(\frac{1}{R_1} - \frac{1}{R_2} \right)$$

On using sign convention, $R_1 = +ve$ and $R_2 = -ve$

Also $n_g = 1.5$ and $n_w = 1.33$

$$\frac{1}{f_w} = \frac{1.5}{1.33} \left(\frac{1}{R_1} - \frac{1}{R_2} \right)$$

$$\frac{1}{R_1} - \frac{1}{R_2} = +ve$$

and $\frac{1.5}{1.33} > 1$ \therefore $f_w = +ve$

Hence, $f_w = +ve$

So, the lens behaves as a converging lens.

6. Metal A

Since work function $W = h \nu_0$

and ν_0 so work function of metal A is more.

Aliter:

On stopping potential axis $\frac{0}{e} \quad \frac{0}{e}$.

Hence work function ν_0 of metal A is more.

7. Infrared radiation

9. Flow of current in the conductor due to drift velocity of the free electrons is given by

$$I = neAv_d$$

$$v_d = \frac{I}{neA} = \frac{1.8 \text{ A}}{9 \times 10^{28} \times 1.6 \times 10^{-19} \times 2.5 \times 10^{-7}}$$

$$= 5 \times 10^{-4} \text{ ms}^{-1}$$

12. Explanation is same as Q. 15 Set-I.

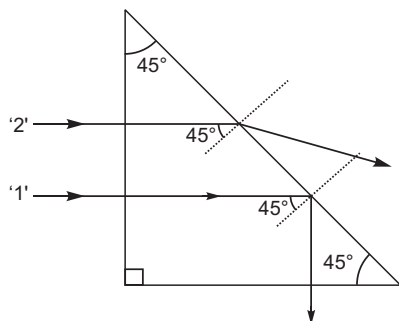

13. (i) **Transmitter:** A transmitter processes the incoming messages/information signals so as to make it at suitable frequency for transmission through a channel.

(ii) **Modulator:** It is a device in which amplitude of a high frequency carrier wave is made to change in accordance with the amplitude of message/information signal during superposition.

21. (a) The incident sunlight is unpolarised. The dots stand for polarisation perpendicular to the plane of the figure. The double arrows show polarisation in the plane of the figure. Under the influence of the electric field of incident radiation, the acceleration of the charges in the scattering molecules can be in two mutually perpendicular directions.

The observer, however, receives the scattered light corresponding to only one of the two sets of accelerated charges *i.e.*, electrons oscillating perpendicular to the direction of propagation.

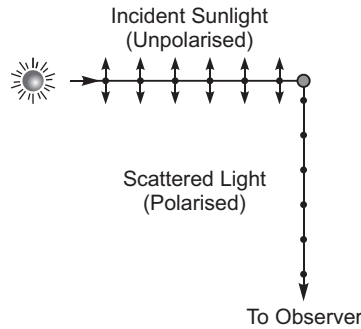

(b) If light of intensity I_0 passes through the first polaroid, the intensity of light transmitted through P_1 is $I_1 = \frac{I_0}{2}$.

Since axis of polaroids P_1 and P_3 are at 30° , so intensity of light transmitted through P_3 is given by

$$I_3 = I_1 \cos^2 45^\circ$$

$$\frac{I_0}{2} \cdot \frac{1}{\sqrt{2}} = \frac{I_0}{4}$$

Light transmitted through P_3 is allowed to pass through P_2 , so intensity of light transmitted through P_2 is $I_2 = I_3 \cos^2 45^\circ$

$$\frac{I_0}{4} \cdot \frac{1}{\sqrt{2}} = \frac{I_0}{8}$$

22. Self inductance – Using formula $\mathcal{E} = -L \frac{dI}{dt}$, if $I = 1$ Ampere then $L =$

Self inductance of the coil is equal to the magnitude of the magnetic flux linked with the solenoid coil, when a unit current flows through it.

or

Using formula $\mathcal{E} = -L \frac{dI}{dt}$

If $\frac{dI}{dt} = 1 \text{ A/s}$ then $L = \frac{\mathcal{E}}{1}$

Self inductance of the coil is equal to the magnitude of induced emf produced in the solenoid coil, when the current varies at rate 1 A/s.

Expression for magnetic energy

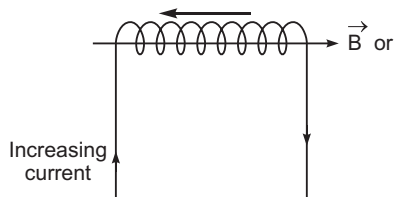

When a time varying current flows through the coil, back emf () produces, which opposes the growth of the current flow. It means some work needs to be done against back emf in establishing a current I . This work done will be stored as magnetic potential energy.

For the current I at any instant, the rate of work done is

$$\frac{dW}{dt} = ()I$$

Only for inductive effect of the coil $| \quad | \quad L \frac{dI}{dt}$

$$\frac{dW}{dt} = L \frac{dI}{dt} I$$

$$dW = LI dI$$

From work-energy theorem

$$dU = LI dI$$

$$U = \int_0^I LI dI = \frac{1}{2} LI^2$$

24.

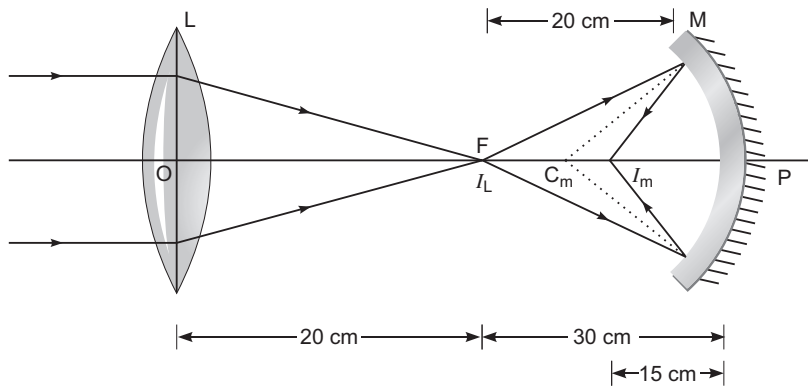

For the convex lens,

$$u = \infty, f = 20 \text{ cm}$$

$$\frac{1}{f} = \frac{1}{v} + \frac{1}{u}$$

$$v = 20 \text{ cm}$$

For the concave mirror, the image formed by the lens acts as the object.

Hence, $u = (50 - 20) \text{ cm} = 30 \text{ cm}$ and $f = 10 \text{ cm}$

Using mirror formula, we get

$$\frac{1}{v} + \frac{1}{u} = \frac{1}{f}$$

$$\frac{1}{v} + \frac{1}{30} = \frac{1}{10}$$

$$\frac{1}{v} = \frac{1}{10} - \frac{1}{30} = \frac{1}{15}$$

$$v = 15 \text{ cm}$$

The lens-mirror combination, therefore, forms a real image I_2 at a distance of 15 cm to the left of the concave mirror or at a distance of 35 cm to the right of the convex lens.

SET-III (Questions Uncommon to Set-I and II)

2. From the graph $\phi_0 = 0$

So, the minimum frequency at which the photoemission starts is more for metal A. Hence metal A has higher threshold frequency.

5. If the field lines cross each other, then at the point of intersection, there will be two directions for the same electric field which is not possible.

6. Microwaves or short radiowaves.

10. We know that

$$I = neAv_d$$

$$v_d = \frac{I}{neA}$$

$$\frac{2.7}{9 \times 10^{28} \times 1.6 \times 10^{-19} \times 2.5 \times 10^{-7}}$$

$$7.5 \times 10^{-4} \text{ m/s}$$

18. (i) **Receiver:** It extracts the desired message signals from the received signals at the end of channel.

(ii) **Demodulator:** It is a device used to retrieve information/message signals from the carrier wave at the receiver (or just after the rectifier).

19. For convex lens,

$$u = -40 \text{ cm}, f = 20 \text{ cm}$$

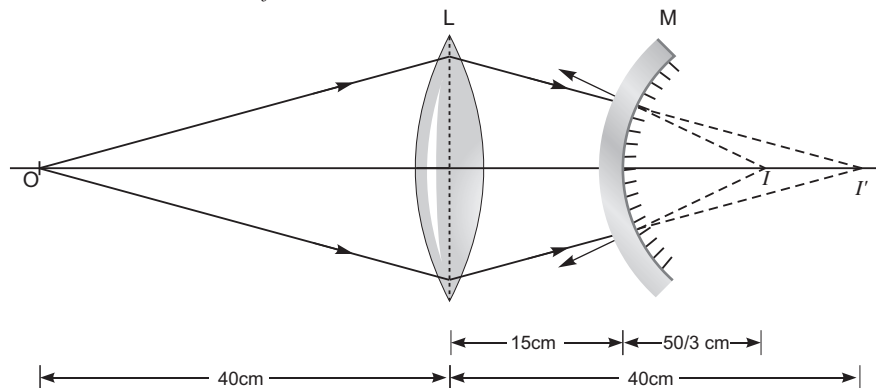

$$\frac{1}{f} = \frac{1}{v} - \frac{1}{u}$$

$$\frac{1}{20} = \frac{1}{v} - \frac{1}{-40}$$

$$\frac{1}{v} = \frac{1}{20} - \frac{1}{40}$$

$$v = +40 \text{ cm}$$

This image acts as a virtual object for the convex mirror.

$$u = 40 - 15 = 25 \text{ cm}$$

$$f = \frac{20}{2} = +10 \text{ cm}$$

Using mirror formula,

$$\frac{1}{f} = \frac{1}{v} + \frac{1}{u} \qquad \frac{1}{10} = \frac{1}{v} + \frac{1}{25}$$

$$\frac{1}{v} = \frac{1}{10} - \frac{1}{25} \qquad v = \frac{15}{3} \text{ cm} \approx 16.67 \text{ cm}$$

Hence, the final image is a virtual image formed at a distance of 16.67 cm.



Suppose a rod of length ' l ' moves with velocity V inward in the region having uniform magnetic field B .

Initial magnetic flux enclosed in the rectangular space is $|B|lx$

As the rod moves with velocity $V = \frac{dx}{dt}$

Using Lenz's law

$$\frac{d}{dt} \frac{d}{dt} (Blx) = Bl \frac{dx}{dt}$$

$$Blv$$

(b) Suppose any arbitrary charge ' q ' in the conductor of length ' l ' moving inward in the field as shown in figure, the charge q also moves with velocity V in the magnetic field B .

The Lorentz force on the charge ' q ' is $F = qvB$ and its direction is downwards.

So, work done in moving the charge ' q ' along the conductor of length l

$$W = F.l$$

$$W = qvBl$$

Since emf is the work done per unit charge

$$\frac{W}{q} = Blv$$

This equation gives emf induced across the rod.



CBSE Examination Paper Foreign-2014

Time allowed : 3 hours

Maximum marks: 70

General Instructions: Same as CBSE Examination Paper Delhi-2014.

SET-I

1. A flexible wire of irregular shape, $abcd$, as shown in the figure, turns into a circular shape when placed in a region of magnetic field which is directed normal to the plane of the loop away from the reader. Predict the direction of the induced current in the wire.

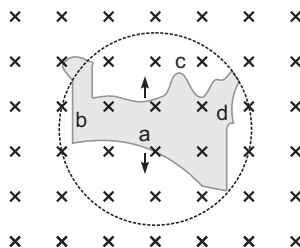

2. Why must electrostatic field at the surface of a charged conductor be normal to the surface at every point? Give reason.
3. Define one tesla using the expression for the magnetic force acting on a particle of charge ' q ' moving with velocity v in a magnetic field B .
4. In both decay processes, the mass number of a nucleus remains same whereas the atomic number Z increases by one in decay and decreases by one in decay. Explain, giving reason.
5. Arrange the following electromagnetic waves in order of increasing frequency:
-rays, microwaves, infrared rays and ultraviolet rays.
6. Figure shows the field lines on a positive charge. Is the work done by the field in moving a small positive charge from Q to P positive or negative? Give reason.

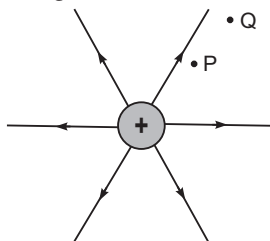

7. In photoelectric effect, why should the photoelectric current increase as the intensity of monochromatic radiation incident on a photosensitive surface is increased? Explain.
8. A ray of light falls on a transparent sphere with centre C as shown in the figure. The ray emerges from the sphere parallel to the line AB . Find the angle of refraction at A if refractive index of the material of the sphere is $\sqrt{3}$.

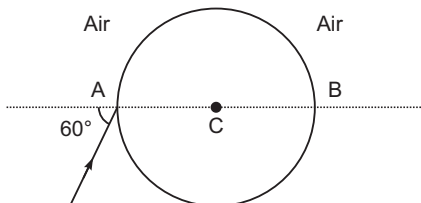

9. Two very small identical circular loops, (1) and (2), carrying equal currents I are placed vertically (with respect to the plane of the paper) with their geometrical axes perpendicular to each other as shown in the figure. Find the magnitude and direction of the net magnetic field produced at the point O .

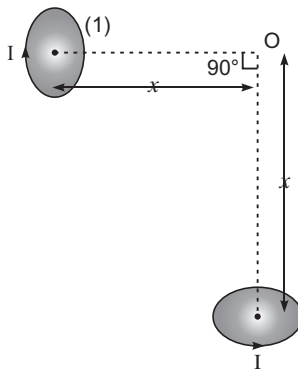

10. Show that the current leads the voltage in phase by $\pi/2$ in an ac circuit containing an ideal capacitor.
11. Give two points to distinguish between a paramagnetic and a diamagnetic substance.
12. Find the charge on the capacitor as shown in the circuit.

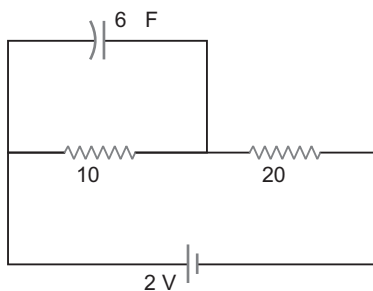

13. Identify the equivalent gate represented by the circuit shown in the figure. Draw its logic symbol and write the truth table.

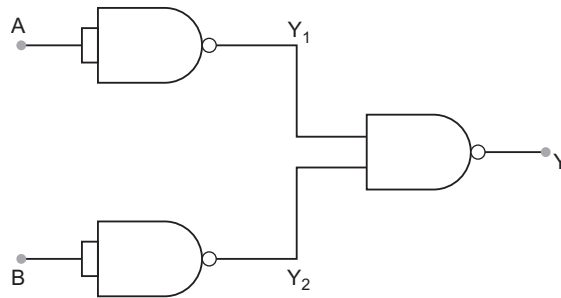

14. Figure shows a ray of light passing through a prism. If the refracted ray QR is parallel to the base BC , show that (i) $r_1 = r_2 = A/2$, (ii) angle of minimum deviation, $D_m = 2i - A$.

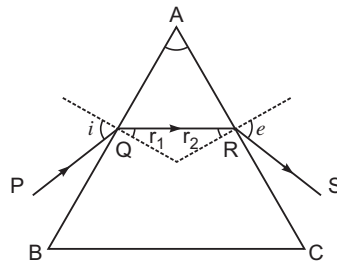

15. Define the term modulation. Draw a block diagram of a simple modulator for obtaining AM signal.
16. (a) How does oscillating charge produce electromagnetic waves?
 (b) Sketch a schematic diagram depicting oscillating electric and magnetic fields of an em wave propagating along +z-direction.
17. Draw energy band diagrams of an n -type and p -type semiconductor at temperature $T > 0$ K. Mark the donor and acceptor energy levels with their energies.

OR

Distinguish between a metal and an insulator on the basis of energy band diagrams.

18. In a series LCR circuit, obtain the conditions under which (i) the impedance of the circuit is minimum, and (ii) wattless current flows in the circuit.
19. The currents flowing in the two coils of self-inductance $L_1 = 16$ mH and $L_2 = 12$ mH are increasing at the same rate. If the power supplied to the two coils are equal, find the ratio of (i) induced voltages, (ii) the currents and (iii) the energies stored in the two coils at a given instant.
20. (a) A point charge ($+Q$) is kept in the vicinity of uncharged conducting plate. Sketch electric field lines between the charge and the plate.

- (b) Two infinitely large plane thin parallel sheets having surface charge densities σ_1 and σ_2 ($\sigma_1 > \sigma_2$) are shown in the figure. Write the magnitudes and directions of the net fields in the regions marked II and III.

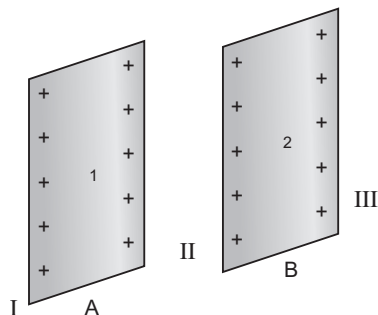

21. (a) Two long straight parallel conductors 'a' and 'b', carrying steady currents I_a and I_b are separated by a distance d . Write the magnitude and direction of the magnetic field produced by the conductor 'a' at the points along the conductor 'b'. If the currents are flowing in the same direction, what is the nature and magnitude of the force between the two conductors?
- (b) Show with the help of a diagram how the force between the two conductors would change when the currents in them flow in the opposite directions.
22. Describe briefly, by drawing suitable diagrams, the (i) sky wave and (ii) space wave modes of propagation. Mention the frequency range of the waves in these modes of propagation.
23. (a) Describe briefly how Davisson – Germer experiment demonstrated the wave nature of electrons.
- (b) An electron is accelerated from rest through a potential V . Obtain the expression for the de-Broglie wavelength associated with it.
24. When Puja, a student of 10th class, watched her mother washing clothes in the open, she observed coloured soap bubbles and was curious to know why the soap bubbles appear coloured. In the evening when her father, an engineer by profession, came home, she asked him this question. Her father explained to her the basic phenomenon of physics due to which the soap bubbles appear coloured.
- (a) What according to you are the values displayed by Puja and her father?
- (b) State the phenomenon of light involved in the formation of coloured soap bubbles.
25. (a) Why is zener diode fabricated by heavily doping both p - and n -sides of the junction?
- (b) Draw the circuit diagram of zener diode as a voltage regulator and briefly explain its working.

OR

- (a) How is photodiode fabricated?
- (b) Briefly explain its working. Draw its V - I characteristics for two different intensities of illumination.
26. (i) Distinguish between unpolarised and linearly polarised light.
- (ii) What does a polaroid consist of? How does it produce a linearly polarised light?
- (iii) Explain briefly how sunlight is polarised by scattering through atmospheric particles.
27. In a parallel plate capacitor with air between the plates, each plate has an area of $6 \times 10^{-3} \text{ m}^2$ and the separation between the plates is 3 mm.
- (i) Calculate the capacitance of the capacitor.
- (ii) If this capacitor is connected to 100 V supply, what would be the charge on each plate?
- (iii) How would charge on the plates be affected, if a 3 mm thick mica sheet of $K = 6$ is inserted between the plates while the voltage supply remains connected?

28. (a) Using Bohr's postulates, derive the expression for the total energy of the electron in the stationary states of the hydrogen atom.
- (b) Using Rydberg formula, calculate the wavelengths of the spectral lines of the first member of the Lyman series and of the Balmer series.

OR

- (a) Define the terms (i) half-life ($T_{1/2}$) and (ii) average life (τ). Find out their relationships with the decay constant (λ).
- (b) A radioactive nucleus has a decay constant $0.3465 \text{ (day)}^{-1}$. How long would it take the nucleus to decay to 75% of its initial amount?
29. (a) State the principle of a potentiometer. Define potential gradient. Obtain an expression for potential gradient in terms of resistivity of the potentiometer wire.
- (b) Figure shows a long potentiometer wire AB having a constant potential gradient. The null points for the two primary cells of emfs \mathcal{E}_1 and \mathcal{E}_2 connected in the manner shown are obtained at a distance of $l_1 = 120 \text{ cm}$ and $l_2 = 300 \text{ cm}$ from the end A . Determine (i) $\mathcal{E}_1 / \mathcal{E}_2$ and (ii) position of null point for the cell \mathcal{E}_1 only.

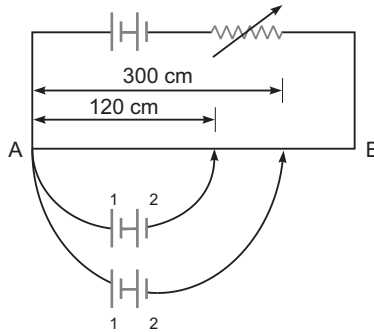

OR

- (a) Define the term 'drift velocity' of charge carriers in a conductor. Obtain the expression for the current density in terms of relaxation time.
- (b) A 100 V battery is connected to the electric network as shown. If the power consumed in the 2 Ω resistor is 200 W, determine the power dissipated in the 5 Ω resistor.

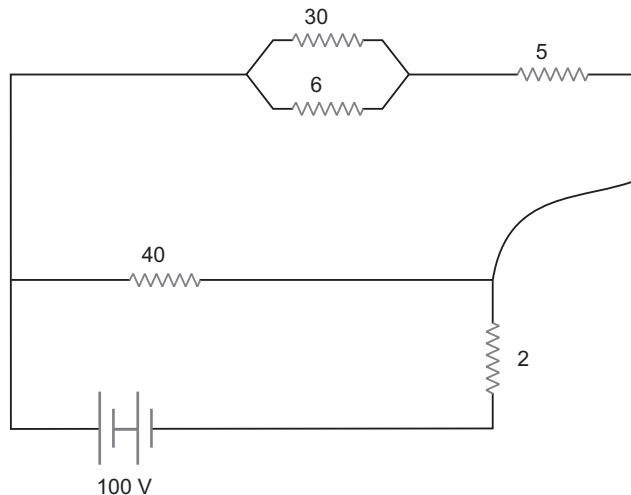

30. (a) Draw a labelled ray diagram of an astronomical telescope to show the image formation of a distant object. Write the main considerations required in selecting the objective and eyepiece lenses in order to have large magnifying power and high resolution of the telescope.
- (b) A compound microscope has an objective of focal length 1.25 cm and eyepiece of focal length 5 cm. A small object is kept at 2.5 cm from the objective. If the final image formed is at infinity, find the distance between the objective and the eyepiece.

OR

- (a) Write three characteristic features to distinguish between the interference fringes in Young's double slit experiment and the diffraction pattern obtained due to a narrow single slit.
- (b) A parallel beam of light of wavelength 500 nm falls on a narrow slit and the resulting diffraction pattern is observed on a screen 1 m away. It is observed that the first minimum is a distance of 2.5 mm away from the centre. Find the width of the slit.

SET-II (Questions Uncommon to Set-I)

2. Use Lenz's law to determine the direction of the induced current when a rectangular conducting loop $abcd$ is moved into a region of magnetic field which is directed normal to the plane of the loop away from the reader.

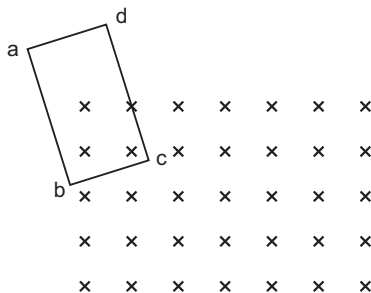

4. Figure shows the field lines due to a negative point charge. Give the sign of the potential energy difference of a small negative charge between the points A and B .

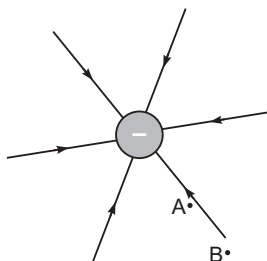

5. Arrange the following electromagnetic waves in order of decreasing frequency:
X-rays, γ -rays, microwaves and infrared rays.
6. Write the expression for the magnetic moment of a circular coil of area A carrying a current I , in a vector form.
8. Plot a graph showing variation of photoelectric current with collector plate potential at a given frequency and intensity of incident radiation. What does the intercept of the graph with potential axis signify?

9. In a series LCR circuit with an ac source of effective voltage 50 V, frequency $\nu = 50/\pi$ Hz, $R = 300 \Omega$, $C = 20 \mu F$ and $L = 1.0$ H. Find the rms current in the circuit.
10. Identify the gate equivalent to the circuit shown in the figure. Write its truth table.

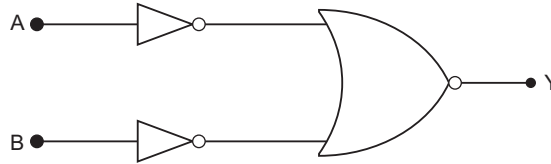

11. In the circuit shown in the figure, find the total resistance of the circuit and the current in the arm CD .

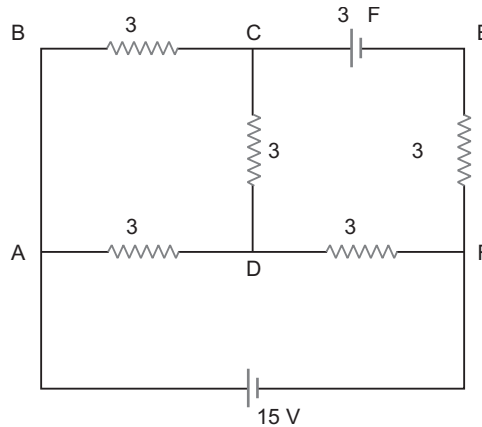

23. In a parallel plate capacitor with air between the plates, each plate has an area of $5 \times 10^{-3} \text{ m}^2$ and the separation between the plates is 2.5 mm.
- Calculate the capacitance of the capacitor.
 - If this capacitor is connected to 100 V supply, what would be the charge on each plate?
 - How would charge on the plates be affected, if a 2.5 mm thick mica sheet of $K = 8$ is inserted between the plates while the voltage supply remains connected?
24. Distinguish with the help of suitable diagrams between ground wave and sky wave modes of propagation. Mention the frequency range of the waves in these modes of propagation.

SET-III (Questions Uncommon to Set-I and II)

1. Figure shows the field lines due to a positive point charge. Give the sign of potential energy difference of a small negative charge between the points Q and P .

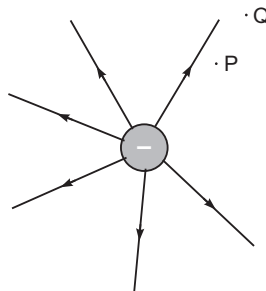

4. A triangular loop of wire placed at abc is moved completely inside a magnetic field which is directed normal to the plane of the loop away from the reader to a new position $a'b'c'$. What is the direction of the current induced in the loop? Give reason.

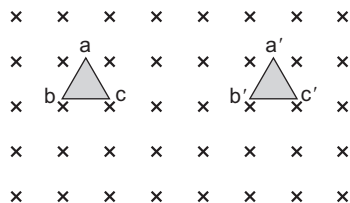

5. An electron in an atom revolves round the nucleus in an orbit of radius r with frequency ν . Write the expression for the magnetic moment of the electron.
7. Arrange the following electromagnetic waves in decreasing order of wavelength:
-rays, infrared rays, X-rays and microwaves.
8. Plot a graph showing the variation of photoelectric current with collector plate potential at a given frequency but for two different intensities I_1 and I_2 , where $I_2 > I_1$.
9. In the circuit shown in the figure, find the total resistance of the circuit and the current in the arm AD .

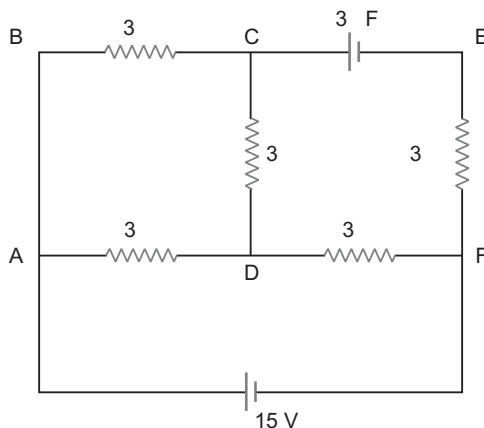

16. Identify the gate equivalent to the circuit shown in the figure. Write its truth table.

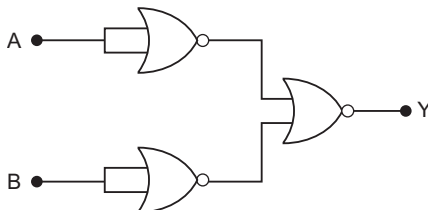

18. A circuit is set up by connecting inductance $L = 100 \text{ mH}$, resistor $R = 100 \text{ } \Omega$ and a capacitor of reactance $200 \text{ } \Omega$ in series. An alternating emf of $150\sqrt{2} \text{ V}$, $500/\pi \text{ Hz}$ is applied across this series combination. Calculate the power dissipated in the resistor.

24. Three concentric metallic shells A , B and C of radii a , b and c ($a < b < c$) have surface charge densities σ_1 , σ_2 and σ_3 respectively as shown in the figure.

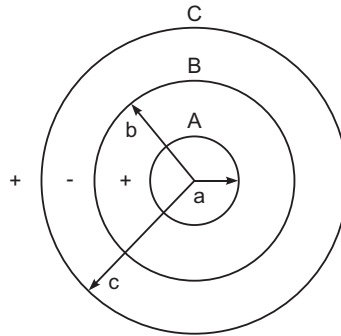

If shells A and C are at the same potential, then obtain the relation between the radii a , b and c .

25. A toroidal solenoid with air core has an average radius of 15 cm, area of cross-section 12 cm^2 and has 1200 turns. Calculate the self-inductance of the toroid. Assume the field to be uniform across the cross-section of the toroid.
26. Explain, with the help of a suitable diagram, the space wave mode of propagation. Give two examples in communication system where this mode is used. What is the frequency range of these waves? Give reason for using this range of frequency.



Solutions

SET-I

1. Anticlockwise or *adcba*.
2. The work done in moving a charge from one point to another on an equipotential surface is zero. If electric field is not normal, it will have a non-zero component along the surface which would cause work to be done in moving a charge on an equipotential surface.
3. One tesla is the magnetic field in which a charge of 1 C moving with a velocity of 1 ms^{-1} , normal to the magnetic field, experiences a force of 1 N.

$$B = \frac{F}{qv \sin \theta}$$

If $F = 1 \text{ N}$, $q = 1 \text{ C}$, $v = 1 \text{ ms}^{-1}$, $\theta = 90^\circ$

then SI unit of $B = \frac{1 \text{ N}}{1 \text{ C} \cdot 1 \text{ ms}^{-1} \cdot \sin 90^\circ}$
 $= 1 \text{ NA}^{-1} \text{ m}^{-1} = 1 \text{ tesla}$

4. In both processes, the conversion of neutron to proton or proton to neutron inside the nucleus.



5. Microwave < Infrared < Ultraviolet < γ -rays
6. The work done by the field is negative. This is because the charge is moved against the force exerted by the field.
7. The photoelectric current increases proportionally with the increase in intensity of incident radiation. Larger the intensity of incident radiation, larger is the number of incident photons and hence larger is the number of electrons ejected from the photosensitive surface.

8. Refractive index, $\frac{\sin i}{\sin r}$

$$\begin{aligned} \sqrt{3} &= \frac{\sin 60^\circ}{\sin r} \\ \sin r &= \frac{\frac{\sqrt{3}}{2}}{\frac{1}{\sqrt{3}}} = \frac{1}{2} \\ \sin r &= \sin 30^\circ \quad \therefore r = 30^\circ \end{aligned}$$

Angle of refraction = 30° .

9. Magnetic field due to coil 1 at point O

$$B_1 = \frac{\mu_0 i R^2}{2(R^2 + x^2)^{3/2}} \text{ along } OC_1$$

Magnetic field due to coil 2 at point O

$$B_2 = \frac{\mu_0 i R^2}{2(R^2 + x^2)^{3/2}} \text{ along } C_2O$$

Both B_1 and B_2 are mutually perpendicular, so the net magnetic field at O is

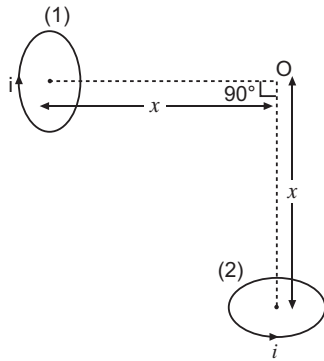

$$B = \sqrt{B_1^2 + B_2^2} = \sqrt{2}B_1 \quad (\text{as } B_1 = B_2)$$

$$= \sqrt{2} \frac{\mu_0 i R^2}{2(R^2 + x^2)^{3/2}}$$

As $R = x$

$$B = \frac{\sqrt{2} \mu_0 i R^2}{2 \cdot x^3} = \frac{\mu_0}{4} \frac{2\sqrt{2} \cdot \mu_0 i (R^2)}{x^3} = \frac{\mu_0}{4} \frac{2\sqrt{2} \mu_0 i A}{x^3}$$

where $A = R^2$ is area of loop.

$$\tan \theta = \frac{B_2}{B_1}$$

$$\tan \theta = 1 \quad (\because B_2 = B_1)$$

$$\theta = \frac{\pi}{4}$$

B is directed at an angle $\frac{\pi}{4}$ with the direction of magnetic field B_1 .

10. The instantaneous voltage,

$$V = V_0 \sin \omega t \quad \dots (i)$$

Let q be the charge on capacitor and I , the current in the circuit at any instant, then instantaneous potential difference,

$$V = \frac{q}{C} \quad \dots (ii)$$

From (i) and (ii)

$$\frac{q}{C} = V_0 \sin \omega t$$

$$q = CV_0 \sin \omega t$$

The instantaneous current,

$$I = \frac{dq}{dt} = \frac{d}{dt}(CV_0 \sin \omega t)$$

$$= CV_0 \frac{d}{dt}(\sin \omega t) = CV_0 \cos \omega t$$

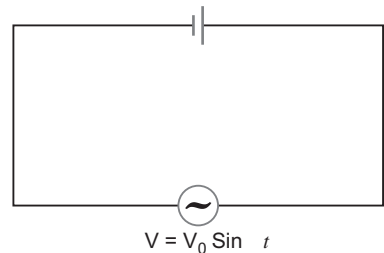

$$I = \frac{V_0}{1/C} \cos t$$

$$I = I_0 \sin t - \frac{\pi}{2}$$

Hence, the current leads the applied voltage in phase by $\pi/2$.

11.

	Property	Diamagnetic	Paramagnetic
1.	Susceptibility and magnetic moment	Negative small	Positive small
2.	Interaction	Feebly repelled by a magnet	Feebly attracted by a magnet.

12. Total resistance, $R = 10 + 20$

The current, $I = \frac{V}{R} = \frac{2V}{30} = \frac{1}{15} A$

Potential difference, $V = IR = \frac{1}{15} \times 10 = \frac{2}{3} V$

Charge, $q = CV$

$$= 6 \times \frac{2}{3} = 4 C$$

13. $C = \bar{A}, D = \bar{B}$

$$Y = \overline{CD} = \overline{\bar{A}\bar{B}} = \bar{\bar{A}\bar{B}} = A + B$$

The logic circuit performs OR-operation.

Truth table.

A	B	Y
0	0	0
1	0	1
0	1	1
1	1	1

14. (i) We know that

$$r_1 = r_2 = A$$

Since QR is parallel to BC

So, $r_1 = r_2$ and $i = e$

Therefore, $2r_1$ or $2r_2 = A$

$$r_1 = r_2 = A/2$$

(ii) $Dm =$ Deviation at the first face + Deviation of the second face

$$(i - r_1) + (e - r_2) = (i - e) + (r_1 - r_2)$$

$$= 2i - A \quad (\because i = e)$$

15. Modulation is the process of super position of low frequency message signal over a high frequency carrier wave.

Amplitude Modulation:

The block diagram is shown in fig.

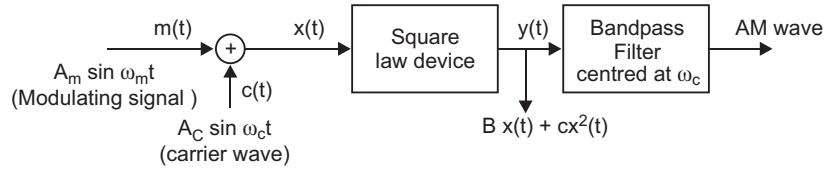

The modulating signal is superposed on carrier wave of high frequency (MHz). The resultant wave so obtained is sent to square law device which produces wave

$$y(t) = Bx(t) + Cx^2(t)$$

This is finally sent to Bandpass filter which rejects dc and sinusoids of frequencies $\omega_m, 2\omega_m, 2\omega_c$ and allows wave of frequency $\omega_c, \omega_c - \omega_m$ and $\omega_c + \omega_m$. The output of Bandpass filter is AM wave.

16. (a) An oscillating charge produces an oscillating electric field in space, which produces an oscillating magnetic field. The oscillating electric and magnetic fields regenerate each other, and this results in the production of em waves in space.
 (b) Electric field is along x-axis and magnetic field is along y-axis.

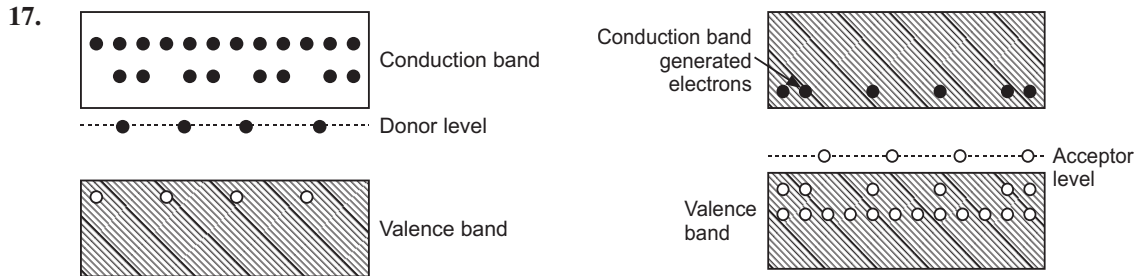
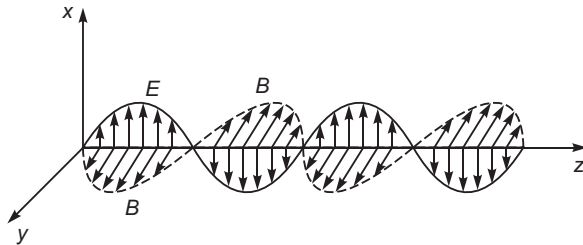

OR

	Metal	Insulators
1.	Conduction band and valence band overlap on each other.	There is large energy gap between conduction band and valence band.
2.	Conduction band is partially filled and valence band is partially empty.	Conduction band is empty. This is because no electrons can be excited to it from valence band.

18. (i) Impedance of series LCR circuit is given by

$$Z = \sqrt{R^2 + (X_L - X_C)^2}$$

For the impedance, Z to be minimum

$$X_L = X_C$$

(ii) Power $P = V_{rms} I_{rms} \cos \phi$

When $\phi = \frac{\pi}{2}$

Power $= V_{rms} I_{rms} \cos \frac{\pi}{2} = 0$

Therefore, wattless current flows when the impedance of the circuit is purely inductive or purely capacitive or the combination of the two.

In another way we can say,

For wattless current to flow, circuit should not have any ohmic resistance ($R = 0$).

19. (i) Induced voltage (emf) in the coil,

$$L \frac{dI}{dt}$$

$$\frac{1}{1} \frac{L_1 \frac{dI}{dt}}{L_2 \frac{dI}{dt}} = \frac{L_1}{L_2} = \frac{16 \text{ mH}}{12 \text{ mH}} = \frac{4}{3}$$

- (ii) Power supplied, $P = I^2 R$

Since power is same for both the coils

$$\frac{I_1^2 R_1}{I_2^2 R_2} = \frac{1}{1} = \frac{2}{1} = \frac{3}{4}$$

- (iii) Energy stored in the coil is given by

$$U = \frac{1}{2} LI^2$$

$$\frac{U_1}{U_2} = \frac{\frac{1}{2} L_1 I_1^2}{\frac{1}{2} L_2 I_2^2}$$

$$\frac{L_1}{L_2} = \frac{I_1^2}{I_2^2} = \frac{4}{3} = \frac{3}{4} = \frac{3}{4}$$

20. (a)

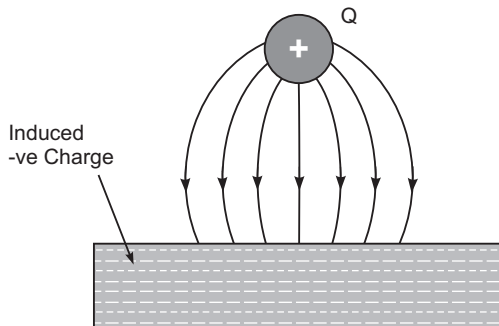

The lines of force start from $+Q$ and terminate at metal place inducing negative charge on it. The lines of force will be perpendicular to the metal surface.

- (b) (i) Net electric field in region II

$$\frac{1}{2} \left(\frac{\sigma}{\epsilon_0} - \frac{\sigma}{\epsilon_0} \right)$$

Direction of electric field is from sheet A to sheet B.

- (ii) Net electric field in region III

$$\frac{1}{2} \left(\frac{\sigma}{\epsilon_0} + \frac{\sigma}{\epsilon_0} \right)$$

Direction is away from the two sheets i.e. towards right side.

21. (a) The magnitude of magnetic field produced by conductor 'a' at a point on the conductor 'b' is given by.

$$B = \frac{\mu_0 I_a}{2d}$$

The direction of magnetic field produced will be inward or outward perpendicular to the plane of conductors depending on the direction of flow of current in conductor 'a'.

Magnitude of force per unit length $\frac{\mu_0 I_a I_b}{2d}$

Nature of force between the two conductors is attractive.

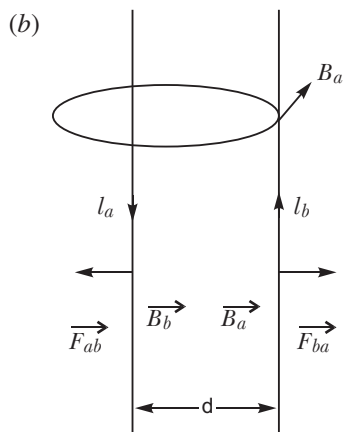

22. (i) A radiowave directed towards the sky and reflected by the ionosphere towards the desired location of the earth is called a sky wave.
Frequency range: Few MHz to 40 MHz.
- (ii) Space wave propagation is a straight line (or line of sight) propagation of electromagnetic wave from transmitting antenna to receiving antenna both installed on the ground.
Frequency range: Above 40 MHz.
23. (a) **Davisson and Germer Experiment:** In 1927 Davisson and Germer performed a diffraction experiment with electron beam in analogy with X-ray diffraction to observe the wave nature of matter.

Apparatus: It consists of three parts

- (i) **Electron Gun:** It gives a fine beam of electrons. de Broglie used electron beam of energy 54 eV. de Broglie wavelength associated with this beam

$$\frac{h}{\sqrt{2mE_K}}$$

Here m mass of electron = 9.1×10^{-31} kg

$$E_K \text{ Kinetic energy of electron} = 54 \text{ eV} \\ = 54 \times 1.6 \times 10^{-19} \text{ joule} = 86.4 \times 10^{-19} \text{ joule}$$

$$\frac{6.6 \times 10^{-34}}{\sqrt{2 \times 9.1 \times 10^{-31} \times 86.4 \times 10^{-19}}} \\ 1.66 \times 10^{-10} \text{ m} \quad \mathbf{1.66 \text{ \AA}}$$

(ii) **Nickel Crystal:** The electron beam was directed on nickel crystal against its (iii) face. The smallest separation between nickel atoms is 0.914 \AA . Nickel crystal behaves as diffraction grating.

(iii) **Electron Detector:** It measures the intensity of electron beam diffracted from nickel crystal. It may be an ionisation chamber fitted with a sensitive galvanometer. The energy of electron beam, the angle of incidence of beam on nickel crystal and the position of detector can all be varied.

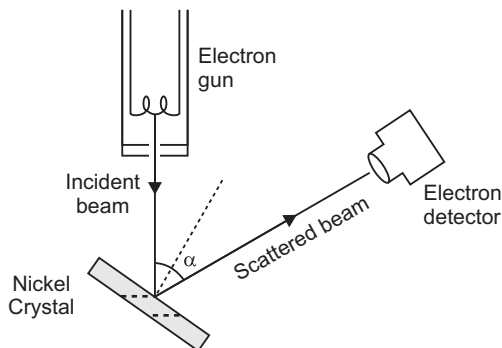

Method: The crystal is rotated in small steps to change the angle (say) between incidence and scattered directions and the corresponding intensity (I) of scattered beam is measured. The variation of the intensity (I) of the scattered electrons with the angle of scattering is obtained for different accelerating voltages.

The experiment was performed by varying the accelerating voltage from 44 V to 68 V. It was noticed that a strong peak appeared in the intensity (I) of the scattered electron for an accelerating voltage of 54 V at a scattering angle 50° .

From Bragg's law

$$\text{Here } n = 1, d = 0.914 \text{ \AA}, \theta = 25^\circ \\ \frac{2d \sin \theta}{n} \\ \frac{2 \times (0.914 \text{ \AA}) \sin 25^\circ}{1} \\ 2 \times 0.914 \times 0.9063 \text{ \AA} = 1.65 \text{ \AA}$$

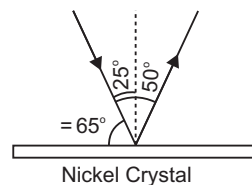

The measured wavelength is in close agreement with the estimated de Broglie wavelength. Thus the wave nature of electron is verified. Later on G.P. Thomson demonstrated the wave nature of fast electrons. Due to their work Davission and G.P. Thomson were awarded Nobel prize in 1937.

Later on experiments showed that *not only electrons but all material particles in motion (e.g., neutrons, α -particles, protons etc.) show wave nature.*

(b) de Broglie wavelength associated with electrons is given by

$$\frac{h}{p} = \frac{h}{2mK}$$

But kinetic energy $K = eV$

$$\frac{h}{\sqrt{2meV}}$$

24. (a) Values displayed by Puja: Observation, curiosity.
 Values displayed by Father: Sense of duty, knowledge.
 (b) Interference of light due to soap bubbles.

25. (a) Due to heavy doping, the depletion layer become very thin and electric field across the junction becomes very high even for a small reverse bias voltage.

- (b) **Working:** The unregulated dc voltage output of a rectifier is connected to the zener diode through a series resistance R_s such that the zener diode is reverse biased. Now, any increase/decrease in the input voltage results in increase/decrease of the voltage drop across R_s without any change in voltage across the zener diode. Thus, the zener diode acts as a voltage regulator.

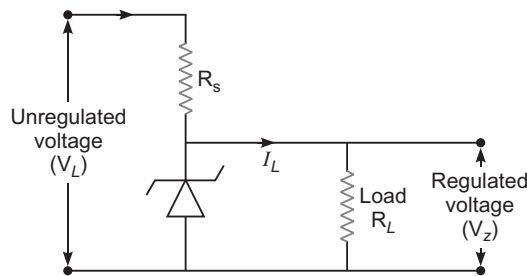

OR

- (a) A photodiode is fabricated with a transparent window to allow light to fall on the diode.
 (b) **Working:** When a reverse bias photodiode is illuminated with light of energy greater than the forbidden energy gap (E_g) of the semiconductor, then electron hole pair are generated in the depletion region. Due to electric field of the junction, electrons are collected on the n -side and holes on p -side, giving rise to an emf.

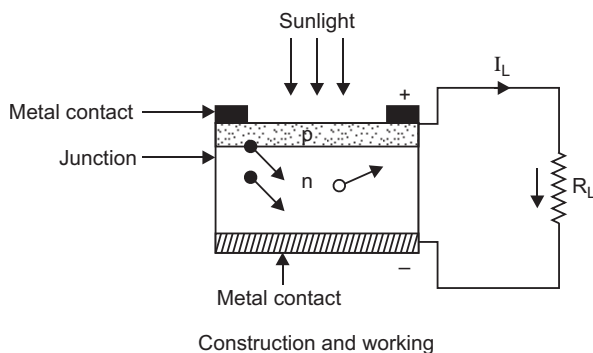

Construction and working



Symbol

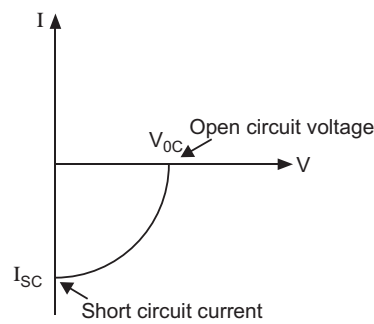

(b)

26. (i) In unpolarised light, the vibrations of light vectors occur simultaneously in all possible directions in a plane perpendicular to the direction of propagation of light.
 The phenomenon of restricting the vibrations of light vector in a particular direction, perpendicular to the directions of wave motion is called polarisation of light. Thus, in polarised light, these vibrations are only along one direction.
 (ii) A polaroid consists of long chain molecules aligned in a particular direction. The electric vectors along the direction of the aligned molecules get absorbed. So, when an unpolarised

light falls on a polaroid, it lets only those of its electric vectors that are oscillating along a direction perpendicular to its aligned molecules to pass through it. The incident light thus gets linearly polarised.

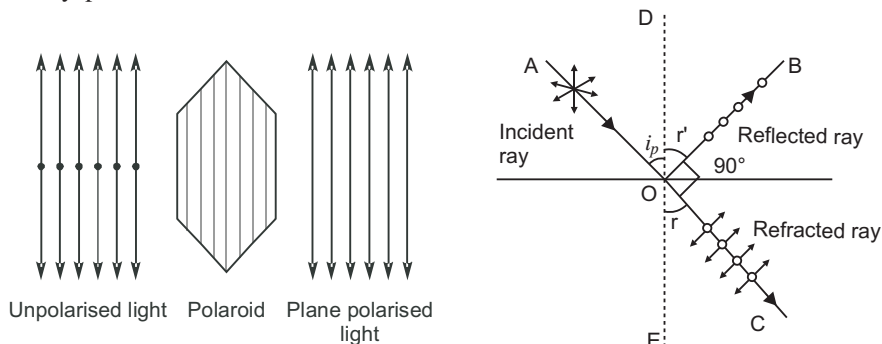

Whenever unpolarised light is incident on the boundary between two transparent media, the reflected light gets partially or completely polarised. When reflected light is perpendicular to the refracted light, the reflected light is a completely polarised light.

- (iii) As the light is incident on the molecules of the atmosphere, electrons of the molecules are set into vibration in the two perpendicular directions and are accelerated. The observer receives scattered light corresponding to only one of the two sets of accelerated charge i.e., electrons oscillating perpendicular to the direction of propagation.

27. Here, $A = 6 \times 10^{-3} \text{ m}^2$, $d = 3 \text{ mm} = 3 \times 10^{-3} \text{ m}$

(i) Capacitance, $C = \frac{\epsilon_0 A}{d}$

$$\frac{8.85 \times 10^{-12} \times 6 \times 10^{-3}}{3 \times 10^{-3}} = 17.7 \times 10^{-12} \text{ F}$$

(ii) Charge, $Q = CV$

$$17.7 \times 10^{-12} \times 100 = 1.77 \times 10^{-10} \text{ C}$$

(iii) New charge, $Q = KQ$

$$6 \times 1.77 \times 10^{-10} = 1.062 \times 10^{-9} \text{ C}$$

28. (a) Suppose m be the mass of an electron and v be its speed in n th orbit of radius r . The centripetal force for revolution is produced by electrostatic attraction between electron and nucleus.

$$\frac{mv^2}{r} = \frac{1}{4\pi\epsilon_0} \frac{(Ze)(e)}{r^2} \quad \dots (i)$$

or, $mv^2 = \frac{1}{4\pi\epsilon_0} \frac{Ze^2}{r}$

So, Kinetic energy $[K] = \frac{1}{2} mv^2$

$$K = \frac{1}{4\pi\epsilon_0} \frac{Ze^2}{2r}$$

$$\text{Potential energy} = \frac{1}{4\pi\epsilon_0} \frac{(Ze)(-e)}{r} = -\frac{1}{4\pi\epsilon_0} \frac{Ze^2}{r}$$

Total energy,

$$E = KE + PE = \frac{1}{4} \frac{Z e^2}{0} - \frac{1}{2r} = \frac{1}{4} \frac{Z e^2}{0} - \frac{1}{r}$$

$$E = \frac{1}{4} \frac{Z e^2}{0} - \frac{1}{2r}$$

For n th orbit, E can be written as E_n

$$\text{so, } E_n = \frac{1}{4} \frac{Z e^2}{0} - \frac{1}{2 r_n} \quad \dots(ii)$$

Again from Bohr's postulate for quantization of angular momentum.

$$mvr = \frac{n h}{2} \quad v = \frac{nh}{2 mr}$$

Substituting this value of v in equation (i), we get

$$\frac{m}{r} \frac{n h}{2 mr} = \frac{1}{4} \frac{Z e^2}{0} - \frac{1}{r^2}$$

$$\text{or, } r = \frac{0 h^2 n^2}{m Z e^2}$$

$$\text{or, } r_n = \frac{0 h^2 n^2}{m Z e^2} \quad \dots(iii)$$

Substituting value of r_n in equation (ii), we get

$$E_n = \frac{1}{4} \frac{Z e^2}{0} - \frac{1}{2 \frac{0 h^2 n^2}{m Z e^2}} = \frac{m Z^2 e^4}{8 0 h^2 n^2}$$

$$\text{or, } E_n = \frac{Z^2 R h c}{n^2}, \text{ where } R = \frac{m e^4}{8 0 c h^3}$$

R is called Rydberg constant.

$$\text{For hydrogen atom } Z = 1, \quad E_n = \frac{R h c}{n^2}$$

If n_i and n_f are the quantum numbers of initial and final states and E_i & E_f are energies of electron in H-atom in initial and final state, we have

$$E_i = \frac{R h c}{n_i^2} \quad \text{and} \quad E_f = \frac{R h c}{n_f^2}$$

If ν is the frequency of emitted radiation.

$$\text{we get } h \nu = E_i - E_f$$

$$\frac{R c}{n_i^2} - \frac{R c}{n_f^2} = h \nu \quad R c \left(\frac{1}{n_f^2} - \frac{1}{n_i^2} \right)$$

- For Balmer series $n_f = 2$, while $n_i = 3, 4, 5, \dots$

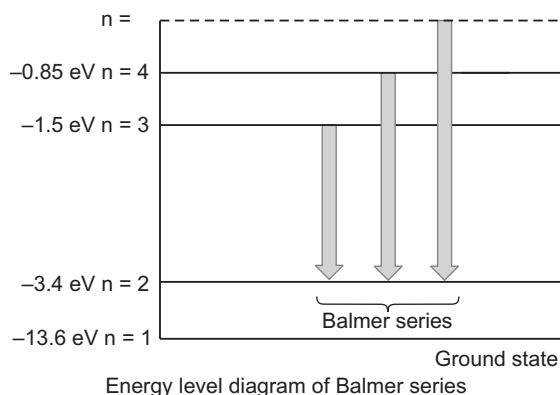

(b) Rydberg formula for the first member of Lyman series

$$\frac{1}{\lambda} = R \left(\frac{1}{1^2} - \frac{1}{2^2} \right)$$

$$\frac{1}{\lambda} = R \left(1 - \frac{1}{4} \right)$$

$$\frac{1}{\lambda} = R \left(\frac{3}{4} \right) \quad \frac{4}{3R}$$

Rydberg formula for the first member of Balmer series

$$\frac{1}{\lambda} = R \left(\frac{1}{2^2} - \frac{1}{3^2} \right)$$

$$\frac{1}{\lambda} = R \left(\frac{1}{4} - \frac{1}{9} \right)$$

$$\frac{1}{\lambda} = R \left(\frac{5}{36} \right) \quad \frac{36}{5R}$$

OR

(a) (i) Half life ($T_{1/2}$) of a radioactive element is defined as the time taken by a radioactive nuclei to reduce to half of the initial number of radio nuclei.

(ii) Average life of a radioactive element is defined as the ratio of total life time of all radioactive nuclei, to the total number of nuclei in the sample.

Relation between half life and decay constant is given by

$$T_{1/2} = \frac{0.693}{\lambda}$$

Relation between average life and decay constant $\tau = \frac{1}{\lambda}$.

(b) Let N_0 = the number of radioactive nuclei present initially at time $t = 0$ in a sample of radioactive substance.

N = the number of radioactive nuclei present in the sample at any instant t .

Here, $N = \frac{3}{4} N_0$

From the equation, $N = N_0 e^{-\lambda t}$

$$\frac{3}{4} N_0 = N_0 e^{-0.3465t}$$

$$e^{0.3465t} = \frac{4}{3}$$

$$0.3465 t = \log_e \frac{4}{3}$$

$$2.303(\log 4 - \log 3)$$

$$2.303(0.6020 - 0.4771) = 2.303 \times 0.1249$$

$$t = \frac{2.303 \times 0.1249}{0.3465} = 0.83 \text{ days.}$$

29. (a) It is based on the fact that the fall of potential across any segment of the wire is directly proportional to the length of the segment of the wire, provided wire is of uniform area of cross-section and a constant current is flowing through it.

$$V \propto l$$

Potential gradient is the fall of potential per unit length of potentiometer wire.

$$\text{Potential gradient } K = \frac{V}{l}$$

$$\frac{IR}{l} \quad (\because V = IR)$$

$$\frac{I \frac{l}{A}}{l} \quad \because R = \frac{l}{A}$$

$$\frac{I}{A}$$

- (b) (i) Let $k =$ potential gradient in V/cm

$$l_1 = l_2 \quad 300k \quad \dots(i)$$

$$l_1 = l_2 \quad 120k \quad \dots(ii)$$

$$\text{We can solve, } \frac{1}{2} = \frac{7}{3}$$

- (ii) From equation (i)

$$l_1 = l_2 \quad 300k$$

$$l_1 = \frac{3}{7} l_1 \quad 300k \quad \quad \quad l_1 = 210k$$

Therefore, balancing length for cell l_1 is 210 cm.

- (iii) By decreasing potential gradient

OR

- (a) The average velocity with which the free electrons in a conductor get drifted towards the positive end of the conductor under the influence of an electric field applied across the conductor.

$$v_d = \frac{eE}{m}$$

where τ is relaxation time.

$$I = neAv_d$$

where e is the charge on electron.

$$I = neA \frac{eE}{m} = neA \frac{eE}{m}$$

$$\text{Current density } J = \frac{I}{A} = \frac{ne^2E}{m}$$

(b) Power, $P = I^2R$

$$200 = I^2 \times 2$$

$$I^2 = \frac{200}{2}$$

$$I = \sqrt{100} = 10 \text{ A}$$

Current flowing through 2Ω resistor = 10 A

Potential drop across 2Ω resistor, $V = IR$

$$= 10 \times 2 = 20 \text{ V}$$

Equivalent resistance of 30Ω and 6Ω

$$\frac{30 \times 6}{30 + 6} = \frac{180}{36} = 5$$

Therefore, potential across parallel combination of 40Ω and 10Ω

$$= 10 \times \frac{8}{10} = 8 \text{ V}$$

Current through 5Ω resistor

$$I = \frac{8 \text{ V}}{10 \Omega} = 0.8 \text{ A}$$

$$\text{Power dissipated in } 5 \Omega \text{ resistor} = I^2R = 0.8^2 \times 5 = 3.2 \text{ W}$$

30. (a)

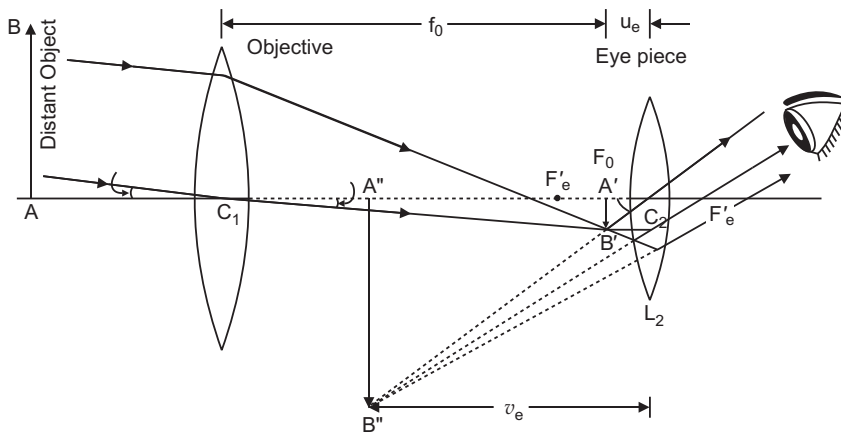

$$\text{Magnifying power, } m = \frac{f_o}{f_e}$$

For large magnifying power f_o should be large and f_e should be small.

For high resolution of the telescope, diameter of the objective should be large.

(b) Using $\frac{1}{v_o} \quad \frac{1}{u_o} \quad \frac{1}{f_o}$

$$\frac{1}{v_o} \quad \frac{1}{2.5} \quad \frac{1}{1.25}$$

$$\frac{1}{v_o} \quad \frac{1}{1.25} \quad \frac{1}{2.5}$$

$$\frac{1}{v_o} \quad \frac{4}{5} \quad \frac{2}{5}$$

$$\frac{1}{v_o} \quad \frac{4}{5} \quad \frac{2}{5}$$

$$v_o \quad 2.5 \text{ cm}$$

$$f_o \quad 2.5 \text{ cm}$$

Distance between objective and eyepiece

$$L = |f_o| + |f_e| = 2.5 + 5.0 = 7.5 \text{ cm.}$$

OR

(a) Difference between interference and diffraction

Interference	Diffraction
(i) It is due to the superposition of two waves coming from two coherent sources.	(i) It is due to the superposition of secondary wavelets originating from different parts of the same wavefront.
(ii) The width of the interference bands is equal.	(ii) The width of the diffraction bands is not the same.
(iii) The intensity of all maxima (fringes) is same.	(iii) The intensity of central maximum is maximum and goes on decreasing rapidly with increase of order of maxima.

(b) The distance of nth bright fringe from central fringe is,

$$y_n = \frac{n D}{d}$$

$$\text{Width } d = \frac{n D}{y_n}$$

$$\frac{1}{2.5} = \frac{500 \times 10^9}{10^3} \times \frac{1}{2 \times 10^4} \text{ m} = 0.2 \text{ mm}$$

SET-II (Questions Uncommon to Set-I)

2. Anticlockwise

$$4. U = \frac{1}{4 \pi \epsilon_0} \cdot \frac{q_1 q_2}{r}$$

Here, $U_A = U_B$

Therefore, $U_A - U_B$ is positive.

5. γ -rays > X-rays > Infrared rays > microwaves

6. Magnetic moment $M = I A$

8.

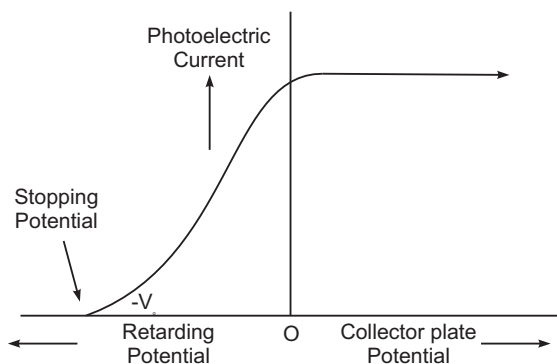

Intercept of the graph with potential axis gives the stopping potential.

9. Here, $L = 1.0 \text{ H}$; $C = 20 \times 10^{-6} \text{ F}$

$$R = 300 \text{ } ; V_{rms} = 50 \text{ V}$$

$$\frac{50}{2} \text{ Hz}$$

Inductive reactance $X_L = \omega L = 2\pi f L$

$$= 2 \times \frac{50}{2} \times 1 \times 100$$

Capacitive reactance, $X_C = \frac{1}{\omega C} = \frac{1}{2\pi f C}$

$$= \frac{1}{2 \times \frac{50}{2} \times 20 \times 10^{-6}} = 500$$

Impedance of circuit

$$Z = \sqrt{R^2 + (X_C - X_L)^2}$$

$$= \sqrt{(300)^2 + (500 - 100)^2}$$

$$= \sqrt{90000 + 160000} = \sqrt{250000} = 500$$

$$I_{rms} = \frac{V_{rms}}{Z} = \frac{50}{500} = 0.1 \text{ A}$$

10. The output $Y = \overline{\overline{A} \overline{B}} = \overline{\overline{A} \overline{B}} = AB$

That is equivalent gate is 'AND' gate.

The symbol and truth table are shown in fig.

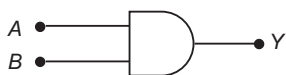

Truth Table

A	B	Y
0	0	0
1	0	0
0	1	0
1	1	1

11. BC and CD are in series, so their effective resistance is 6Ω .

Now their combination is in parallel with AD ,

$$\text{So, } \frac{1}{R} = \frac{1}{3} + \frac{1}{6} = \frac{6}{3} + \frac{3}{6} = \frac{1}{2}$$

$$R = 2 \Omega$$

Total resistance of the circuit

$$R_{AF} = (2 + 3) \Omega = 5 \Omega$$

$$\text{Net current, } I = \frac{V}{R} = \frac{15}{5} = 3 \text{ A}$$

Hence $I_{CD} = 1 \text{ A}$

23. (i) Capacitance, $C = \frac{\epsilon_0 A}{d}$

$$= \frac{8.85 \times 10^{-12} \times 5 \times 10^{-3}}{2.5 \times 10^{-3}}$$

$$= 17.7 \times 10^{-12} \text{ F}$$

(ii) Charge $Q = CV$

$$= 17.7 \times 10^{-12} \times 100$$

$$= 1.77 \times 10^{-10} \text{ C}$$

(iii) New charge, $Q = KQ$

$$= 8 \times 1.77 \times 10^{-10}$$

$$= 1.416 \times 10^{-9} \text{ C}$$

24. **Ground wave propagation:** The mode of propagation in which wave glides over the surface of the earth is called ground wave propagation.

Frequency range: Few MHz $<$ 2 MHz

Sky wave propagation is ionospheric reflection of radio wave back to the earth.

Frequency range: Few MHz to 40 MHz.

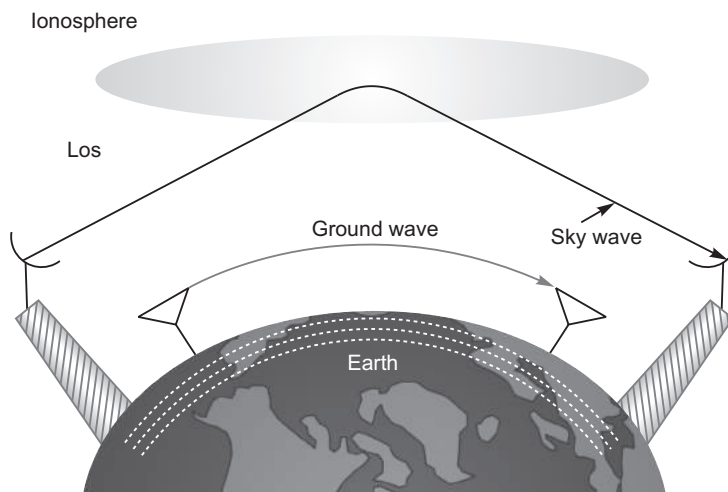

SET-III (Questions Uncommon to Set-I and II)

$$1. U = \frac{1}{4\pi\epsilon_0} \cdot \frac{q_1 q_2}{r}$$

Here, $U_Q = U_P$

Therefore, $U_Q - U_P$ is negative.

4. As there is no change in magnetic flux, so no current is induced in the loop.

5. Magnetic moment

$$M = \frac{e}{4m} n$$

where h = Planck's constant and n = natural number = 1, 2, 3...

7. Microwave > Infrared > X-rays > γ -rays

8.

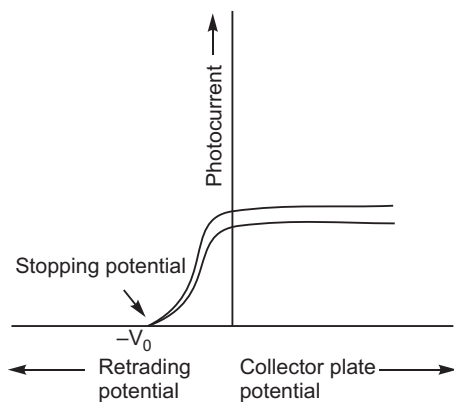

9. Since BC and CD are in series,

$$\text{So, } R_{BCD} = 3 + 3 = 6$$

Also AD is parallel with the combination of BC and CD .

$$\frac{1}{R_P} = \frac{1}{6} + \frac{1}{3} = \frac{6+3}{6 \cdot 3}$$

$$R_P = 2$$

Then DF is in series,

$$R_{eq} = 2 + 3 = 5$$

$$\text{Net current } I = \frac{V}{R_{eq}} = \frac{15}{5} = 3A$$

$$I_{AD} = 2A.$$

16. Output of gate (1), $Y_1 = \overline{\overline{A} \cdot \overline{A}} = \overline{A}$

Output of gate (2), $Y_2 = \overline{\overline{B} \cdot \overline{B}} = \overline{B}$

Output $Y = Y_1 \cdot Y_2 = \overline{\overline{A} \cdot \overline{B}} = \overline{\overline{A} \cdot \overline{B}} = AB$

Thus, gate (1) and (2) act on 'NOT' gates and the complete circuit acts as 'AND' gate. The symbol and truth table of complete circuit are given below:

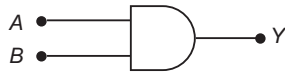

Truth Table

A	B	Y
0	0	0
1	0	0
0	1	0
1	1	1

18. Here, $L = 100 \times 10^{-3} H$
 $R = 100$
 $X_C = 200$
 $V_{rms} = 150\sqrt{2}V$
 $\frac{500}{2} \text{ Hz.}$

Inductive reactance $X_L = \omega L = 2\pi \times \frac{500}{2} \times 100 \times 10^{-3} = 100.$

Impedance of circuit

$$Z = \sqrt{R^2 + (X_C - X_L)^2}$$

$$= \sqrt{(100)^2 + (200 - 100)^2}$$

$$= \sqrt{20000} = 100\sqrt{2}$$

$$I_{rms} = \frac{V_{rms}}{Z} = \frac{150\sqrt{2}}{100\sqrt{2}} = \frac{3}{2}$$

Power dissipated $(I_{rms})^2 R$

$$= \frac{9}{4} \times 100 = 225 \text{ W}$$

24. Charge on shell A, $q_A = 4\pi a^2 \sigma$

Charge on shell B, $q_B = 4\pi b^2 \sigma$

Charge of shell C, $q_C = 4\pi c^2 \sigma$

Potential of shell A: Any point on the shell A lies inside the shells B and C.

$$V_A = \frac{1}{4\pi\epsilon_0} \left[\frac{q_A}{a} + \frac{q_B}{b} + \frac{q_C}{c} \right]$$

$$= \frac{1}{4\pi\epsilon_0} \left[\frac{4\pi a^2 \sigma}{a} + \frac{4\pi b^2 \sigma}{b} + \frac{4\pi c^2 \sigma}{c} \right]$$

$$= \frac{\sigma}{\epsilon_0} (a + b + c)$$

Any point on B lies outside the shell A and inside the shell C. Potential of shell B,

$$V_B = \frac{1}{4\pi\epsilon_0} \left[\frac{q_A}{b} + \frac{q_B}{b} + \frac{q_C}{c} \right]$$

$$= \frac{1}{4\pi\epsilon_0} \left[\frac{4a^2}{b} + \frac{4b^2}{b} + \frac{4c^2}{c} \right] = \frac{4}{\pi\epsilon_0} \left[\frac{a^2}{b} + b + c \right]$$

Any point on shell C lies outside the shells A and B. Therefore, potential of shell C.

$$V_C = \frac{1}{4\pi\epsilon_0} \left[\frac{q_A}{c} + \frac{q_B}{b} + \frac{q_C}{c} \right]$$

$$= \frac{1}{4\pi\epsilon_0} \left[\frac{4a^2}{c} + \frac{4b^2}{c} + \frac{4c^2}{c} \right]$$

$$= \frac{4}{\pi\epsilon_0} \left[\frac{a^2}{c} + \frac{b^2}{c} + c \right]$$

Now, we have

$$V_A = V_C$$

$$\frac{4}{\pi\epsilon_0} (a + b + c) = \frac{4}{\pi\epsilon_0} \left[\frac{a^2}{c} + \frac{b^2}{c} + c \right]$$

$$a + b = \frac{(a + b)(a + b)}{c}$$

or $a + b = c$

25. Here, $r = 15 \text{ cm} = 0.15 \text{ m}$
 $A = 12 \text{ cm}^2 = 12 \times 10^{-4} \text{ m}^2$
 $N = 1200$

Self inductance, $L = \frac{\mu_0 N^2 A}{2l}$

$$= \frac{\mu_0 N^2 A}{2r} = \frac{4\pi \times 10^{-7} \times (1200)^2 \times 12 \times 10^{-4}}{2 \times 0.15} = 2.3 \times 10^{-3} \text{ H.}$$

26.

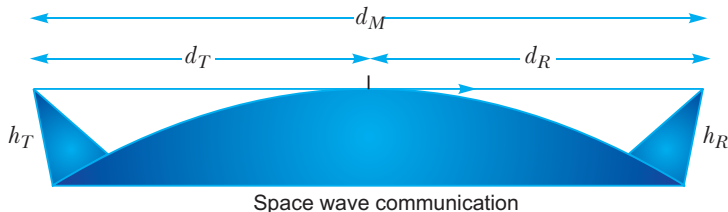

The mode of wave propagation in which the radio waves emitted from the transmitter antenna reaches the receiving antenna through space is called space wave propagation.

Examples: Line of sight communication, Satellite communication.

Frequency range: $> 40 \text{ MHz}$

Frequencies above 40 MHz do not get reflected by the ionosphere.

